

**UNITED STATES  
SECURITIES AND EXCHANGE COMMISSION**  
Washington, D.C. 20549

**Amendment  
No. 1  
FORM S-1  
REGISTRATION STATEMENT**  
*Under  
The Securities Act of 1933*

**ALTAIR ENGINEERING INC.**

(Exact name of registrant as specified in its charter)

Delaware  
(State or other jurisdiction of  
incorporation or organization)

7372  
(Primary Standard Industrial  
Classification Code Number)

38-2591828  
(I.R.S. Employer  
Identification Number)

1820 E. Big Beaver Road  
Troy, Michigan 48083  
(248) 614-2400

(Address, including zip code, and telephone number, including area code, of registrant's principal executive offices)

James R. Scapa  
Chief Executive Officer  
Altair Engineering Inc.  
1820 E. Big Beaver Road, Troy, Michigan 48083  
(248) 614-2400

(Name, address, including zip code, and telephone number, including area code, of agent for service)

Copies to:

Selim Day, Esq.  
Lowenstein Sandler LLP  
1251 Avenue of the Americas  
New York, NY 10020  
(212) 262-6700

William J. Schnoor, Esq.  
Edwin M. O'Connor, Esq.  
Goodwin Procter LLP  
100 Northern Avenue  
Boston, MA 02210  
(617) 570-1000

**Approximate date of commencement of proposed sale to the public:** As soon as practicable after the effective date of this Registration Statement.

If any of the securities being registered on this Form are to be offered on a delayed or continuous basis pursuant to Rule 415 under the Securities Act of 1933 check the following box:

If this Form is filed to register additional securities for an offering pursuant to Rule 462(b) under the Securities Act, please check the following box and list the Securities Act registration statement number of the earlier effective registration statement for the same offering.

If this Form is a post-effective amendment filed pursuant to Rule 462(c) under the Securities Act, check the following box and list the Securities Act registration statement number of the earlier effective registration statement for the same offering.

If this Form is a post-effective amendment filed pursuant to Rule 462(d) under the Securities Act, check the following box and list the Securities Act registration statement number of the earlier effective registration statement for the same offering.

Indicate by check mark whether the registrant is a large accelerated filer, an accelerated filer, a non-accelerated filer, a smaller reporting company, or an emerging growth company. See the definitions of "large accelerated filer," "accelerated filer," "smaller reporting company," and "emerging growth company" in Rule 12b-2 of the Exchange Act.

Large accelerated filer  Accelerated filer   
Non-accelerated filer  (do not check if a smaller reporting company) Smaller reporting company   
Emerging growth company

If an emerging growth company, indicate by check mark if the registrant has elected not to use the extended transition period for complying with any new or revised financial accounting standards provided pursuant to Section 7(a)(2)(B) of the Securities Act.

**Calculation of Registration Fee**

Title of Each Class of Securities to be Registered	Proposed Maximum Aggregate Offering Price <sup>(1)(2)</sup>	Amount of Registration Fee
Class A common stock, par value \$0.0001 per share	\$150,000,000	\$17,385.00

(1) Estimated solely for the purpose of calculating the registration fee in accordance with Rule 457(o) under the Securities Act of 1933, as amended.

(2) Includes the aggregate offering price of the additional shares that the underwriters have the option to purchase to cover over allotments, if any.

**The registrant hereby amends this registration statement on such date or dates as may be necessary to delay its effective date until the registrant shall file a further amendment which specifically states that this registration statement shall thereafter become effective in accordance with section 8(a) of the Securities Act of 1933 or until the registration statement shall become effective on such date as the Securities and Exchange Commission, acting pursuant to said section 8(a), may determine.**

The information in this prospectus is not complete and may be changed. We may not sell these securities until the registration statement filed with the Securities and Exchange Commission is declared effective. This prospectus is not an offer to sell these securities or a solicitation of an offer to buy these securities in any jurisdiction where the offer or sale is not permitted.

Subject to completion, dated October 6, 2017

Prospectus

Shares



## Class A common stock

\$ per share

This is the initial public offering of the Class A common stock of Altair Engineering Inc.

The selling stockholders identified in this prospectus are offering shares of our Class A common stock, and we are offering shares of our Class A common stock in this offering. We will not receive any proceeds from the sales of shares of our Class A common stock by the selling stockholders. The estimated initial public offering price is expected to be between \$ and \$ per share.

We have two classes of common stock, Class A common stock and Class B common stock. The rights of the holders of Class A common stock and Class B common stock are identical, except with respect to voting and conversion rights. Each share of Class A common stock is entitled to one vote per share. Each share of Class B common stock is entitled to ten votes per share and is convertible into one share of Class A common stock. The holders of our outstanding Class B common stock will hold approximately % of the voting power of our outstanding capital stock following this offering, with our directors, executive officers and current beneficial owners of 5% or more and their affiliates holding approximately % of the voting power.

Prior to this offering, there has been no public market for our common stock. We intend to apply to list our Class A common stock on the Nasdaq Global Select Market under the symbol "ALTR."

We are an "emerging growth company" as that term is used in the Jumpstart Our Business Startups Act of 2012, as amended, and may elect to comply with certain reduced United States public company reporting requirements for future filings.

Investing in our Class A common stock involves a high degree of risk. Please see the section entitled "[Risk factors](#)" starting on page 21 to read about risks you should consider carefully before buying shares of our Class A common stock.

Neither the Securities and Exchange Commission nor any state securities commission has approved or disapproved of these securities or passed upon the adequacy or accuracy of this prospectus. Any representation to the contrary is a criminal offense.

	Initial public offering price	Underwriting discounts and commissions <sup>(1)</sup>	Proceeds to the Company, before expenses	Proceeds to the selling stockholders, before expenses
Per share	\$	\$	\$	\$
Total	\$	\$	\$	\$

(1) See the section entitled "Underwriting" for a description of the underwriting discounts and commissions and offering expenses.

We have granted the underwriters a 30-day option to purchase up to an additional shares of Class A common stock at the initial public offering price, less the underwriting discount, to cover over-allotments.

The underwriters expect to deliver the shares on or about , 2017.

**J.P. Morgan**

**RBC Capital Markets**

**Deutsche Bank Securities**

**William Blair**

**Canaccord Genuity**

The date of this prospectus is , 2017

**The world we live in is built on engineering.**

It's in almost everything we touch, a part of every human experience. It's in the planes and trains we sit in, the cars we drive and the elevators we ride to the sky. It's even in the valves that give us heartbeats and the equipment that saves our lives.

**But not all engineering is created equal.**

And without something that's been meticulously constructed, simulated, optimized, challenged and then challenged again — it leaves the design ready to fail.

**That's where Altair makes all the difference.**

It's the difference between soaring through space and contaminating it. Between lightweight and heavyweight. Sinking and swimming. Between an engine that revs politely and an engine that roars. It's the difference between qualifying for the Olympics and cutting a close second.

**So what will you engineer with the power of Altair?**

We ask you to not just design something.

**We ask you to ...DESIGN THE DIFFERENCE™**



## Table of contents

	<b>Page</b>
<a href="#">Prospectus summary</a>	1
<a href="#">Risk factors</a>	21
<a href="#">Information regarding forward looking statements</a>	50
<a href="#">Market, industry and other data</a>	51
<a href="#">Use of proceeds</a>	52
<a href="#">Dividend policy</a>	53
<a href="#">Capitalization</a>	54
<a href="#">Dilution</a>	56
<a href="#">Selected historical consolidated financial and other data</a>	58
<a href="#">Management's discussion and analysis of financial condition and results of operations</a>	63
<a href="#">Business</a>	102
<a href="#">Management</a>	139
<a href="#">Executive compensation</a>	147
<a href="#">Certain relationships and related party transactions</a>	160
<a href="#">Principal and selling stockholders</a>	163
<a href="#">Description of capital stock</a>	166
<a href="#">Shares eligible for future sale</a>	172
<a href="#">Material United States federal income tax consequences to non-U.S. holders of our Class A common stock</a>	176
<a href="#">Underwriting</a>	181
<a href="#">Legal matters</a>	188
<a href="#">Experts</a>	188
<a href="#">Where you can find more information</a>	188
<a href="#">Index to consolidated financial statements</a>	F-1

None of the Company, the selling stockholders or the underwriters have authorized anyone to provide any information or to make any representations other than those contained in this prospectus or in any free writing prospectuses prepared by or on behalf of us or to which we have referred you. The Company, the selling stockholders, and the underwriters take no responsibility for, and can provide no assurance as to the reliability for any other information that others may give you. This prospectus is an offer to sell only the shares offered hereby, only under circumstances and in jurisdictions where it is lawful to do so. The information contained in this prospectus or in any applicable free writing prospectus is current only as of its date, regardless of its time of delivery or any sale of shares of our common stock. Our business, financial condition, results of operations and prospects may have changed since that date.

## Investors outside the United States

None of the Company, the selling stockholders or the underwriters have done anything that would permit this offering or possession or distribution of this prospectus or any free writing prospectus we may provide to you in connection with this offering in any jurisdiction where action for that purpose is required, other than in the United States. You are required to inform yourselves about and to observe any restrictions relating to this offering and the distribution of this prospectus and any such free writing prospectus outside of the United States.

***Until \_\_\_\_\_, 2017 (25 days after the commencement of this offering), all dealers that effect transactions in these securities, whether or not participating in this offering, may be required to deliver a prospectus. This is in addition to the dealers' obligation to deliver a prospectus when acting as an underwriter and with respect to their unsold allotments or subscriptions.***

## Prospectus summary

*This summary provides a brief overview of information contained elsewhere in this prospectus. This summary does not contain all of the information you should consider before investing in our Class A common stock. You should carefully read this prospectus in its entirety including "Risk factors," "Management's discussion and analysis of financial condition and results of operations" and the financial statements and the notes to those financial statements included in this prospectus before investing in our Class A common stock. References to the "selling stockholders" refer to the selling stockholders named in this prospectus.*

### Our vision

Our vision is to transform product design and organizational decision making by applying simulation, optimization and high performance computing throughout product lifecycles.

### Overview

***Altair exists to unleash the limitless potential of the creative mind.***

We are a leading provider of enterprise-class engineering software enabling innovation across the entire product lifecycle from concept design to in-service operation. Our simulation-driven approach to innovation is powered by our broad portfolio of high-fidelity and high-performance physics solvers. Our integrated suite of software optimizes design performance across multiple disciplines encompassing structures, motion, fluids, thermal management, electromagnetics, system modeling, and embedded systems, while also providing data analytics and true-to-life visualization and rendering.

The engineering software industry is challenged by increasingly sophisticated design requirements and enabled by the ever expanding availability of cost effective computing power. Rising expectations of end-market customers, new manufacturing methods such as three-dimensional, or 3D, printing, and new materials such as composites, combined with more powerful math-based computational technologies, are expanding the application of simulation across many industry verticals. The Internet of Things, or IoT, is also changing engineering by broadening the scope of Product Lifecycle Management, or PLM, affording the opportunity to leverage simulation and analytics toward the development of "digital twins" to optimize product performance and manufacturing throughput, predict failure, and schedule maintenance operations for in-service equipment.

CIMdata in its 2017 Simulation and Analysis Market Analysis Report, or the CIMdata Report, forecasts, "the PLM market to grow at a compound annual growth rate (CAGR) of 6.7% to \$56.3 billion" in 2021. The CIMdata Report estimates the computer-aided engineering, or CAE, market which they refer to as Simulation and Analysis, as a subset of the PLM market to be approximately \$5.3 billion and \$5.7 billion in 2016 and 2017, respectively. The CIMdata Report expects the CAE market, "will be one of the more rapidly growing segments within the tools sector of PLM over the next five years, and forecasts that this market sector will exceed \$7.8 billion in 2021, with an 8.1% CAGR."

Altair's engineering and design platform offers a wide range of multi-disciplinary CAE solutions which we believe is one of the most innovative and comprehensive offerings available in the market. To ensure customer success and deepen our relationships with them, we engage with our customers to provide consulting, implementation services, training, and support, especially when applying optimization. Altair participates in five software categories related to CAE and high performance computing, or HPC:

- **Solvers & Optimization:** Solvers are mathematical software "engines" that use advanced computational algorithms to predict physical performance. Optimization leverages solvers to derive the most efficient solutions to meet desired complex multi-objective requirements.
- **Modeling & Visualization:** Tools that allow advanced physics attributes to be modeled and rendered on top of object geometry in high fidelity. These tools are becoming more design-centric and relevant earlier in the development process.
- **Industrial & Concept Design:** Tools that generate early concepts to address requirements for ergonomics, aesthetics, performance, and manufacturing feasibility. These tools are simulation-driven and, we believe, emerging as a market force eclipsing traditional computer-aided design, or CAD.
- **IoT:** Tools to develop new IoT enabled products, including device and data management, system level and full 3D digital twin simulation, and exploration, predictive analysis, optimization, and visualization of in-service performance.
- **HPC:** Software applications that streamline the workflow management of compute-intensive tasks including solvers, optimization, modeling, visualization, and analytics in fields such as PLM, weather modeling, bio-informatics and electronic design analysis. The HPC middleware software market was forecasted to exceed \$1.6 billion by 2019 by the former high performance analyst team of International Data Corporation, or IDC, which is now owned by Hyperion Research Holdings, LLC, or Hyperion, and is not affiliated with IDC.

Our software enables customers to enhance product performance, compress development time, and reduce costs. Our thirty-year heritage is in solving some of the most challenging design problems faced by engineers and scientists. Altair is also a leading provider of high performance computing workflow tools which empower our customers to explore designs in ways not possible in traditional computing environments. We believe we are unique in the industry for the depth and breadth of our engineering application software offerings combined with our domain expertise and proprietary technology for harnessing HPC and cloud infrastructures.

Our primary users are highly educated and technical engineers, commonly referred to as simulation specialists. We predominantly reach customers with simulation specialists through Altair's experienced, direct sales force, especially in industries requiring highly engineered products, such as automotive, aerospace, heavy machinery, rail and ship design. To enable concept engineering driven by simulation we make our physics solvers more accessible to designers, who may be less technical and not expert in simulation, by wrapping them in powerful, yet simple interfaces. We are increasing our use of indirect channels to more efficiently address a broader set of customers in consumer products, electronics, energy and other industries.

Altair pioneered a patented units-based subscription licensing model for software and other digital content. This units-based subscription licensing model allows flexible and shared access to all of our offerings, along with over 150 partner products. Our customers license a pool of units for their organizations giving individual users access to our entire portfolio of software applications as well as our growing portfolio of partner products. We believe our units-based subscription licensing model lowers barriers to adoption, creates broad engagement, encourages users to work within our ecosystem, and increases revenue. This, in turn, helps drive

our recurring software license rate which has been on average approximately 88% over the past five years. Each year approximately 60% of new software revenue comes from expansion within existing customers.

Altair also provides client engineering services, or CES, to support our customers with long-term ongoing product design and development expertise. This has the benefit of embedding us within customers, deepening our understanding of their processes, and allowing us to more quickly perceive trends in the overall market. Our presence at our customers' sites helps us to better tailor our software products' research and development, or R&D, and sales initiatives.

We were founded in 1985 in Michigan and have a balanced global footprint, with 68 offices in 24 countries, and over 2,000 engineers, scientists and creative thinkers. For the six months ended June 30, 2017 we generated 34%, 33% and 33% of our total billings from customers in the Americas region, or the Americas, from the Asia-Pacific region, or APAC, and from the Europe, Middle East and Africa region, or EMEA, respectively. In 2016, we generated 38%, 32% and 30% of our total billings from customers in the Americas, APAC, and EMEA, respectively. Billings by geographical region can vary significantly by quarter. As of June 30, 2017, we had tens of thousands of users across approximately 5,000 customers worldwide. We define customers as a company, an educational or governmental institution, any separate or distinct worksite, a business unit, or a particular group that uses our products or services. Billings consists of our total revenue plus the change in our deferred revenue in a given period and is discussed under "Selected historical consolidated financial and other data—Key metrics" of this prospectus.

We believe a critical component of our success has been our company culture, based on our core values of innovation, envisioning the future, communicating honestly and broadly, seeking technology and business firsts, and embracing diversity. This culture is important because it helps attract and retain top people, encourages innovation and teamwork, and enhances our focus on achieving Altair's corporate objectives.

## **Industry background**

CAE software is essential to innovation across a wide range of highly engineered products in industry verticals ranging from automotive, aerospace, heavy machinery, rail and ship design to consumer electronics and sporting goods. Physical prototypes and testing have been largely supplanted by CAE for design validation over the last twenty-five years. This process continues unabated. Manual drawing and drafting were also replaced by 3D CAD during the same time period. More recently, CAE is emerging in a conceptualization process called simulation-driven design where new design tools are beginning to replace traditional 3D CAD.

CAE software allows engineers to simulate, predict, and optimize how physical products will perform in the real world under a range of operating conditions. CAE applications can accurately solve complex physical interactions through mathematical methods such as finite element analysis, simulate an extensive set of material types, and generate high-fidelity outputs that are realistic virtual representations of physical system behaviors. Modern CAE software can rapidly solve a wide range of complex physics, including structural, fluid, thermal, electromagnetic, system modeling, and embedded system design.

Beyond just simulating physical behavior, CAE can now solve multi-disciplinary optimization problems to numerically optimize parameters and achieve design objectives such as to minimize weight or cost. Utilizing such advanced simulation and optimization methods, engineers and designers can shorten development cycles, virtually test product performance, explore alternatives, and synthesize designs that enhance product functionality, performance and reliability while reducing complexity and costs.



***Principal drivers of growth in demand for simulation & analysis software include:***

*Improving sophistication and fidelity of CAE technologies*

The engineering software industry is challenged by increasingly sophisticated design requirements and enabled by the ever-expanding availability of cost effective computing power. Simulation models continue to grow in size, complexity, and range of physics, driving demand for additional computational power and parallelization algorithms, more powerful modeling and visualization tools and more advanced multi-physics solvers. Advances in computing infrastructure have kept pace over time, drastically reducing the time it takes to perform complex simulations and solve large-scale problems such as automotive crash simulation, fluid-structure interaction of subsea oil pipelines and detailed composite simulation of full aircraft structures. As these models continue to grow larger and solve faster, the knowledge and power of these methods to impact design decisions expands across a department, an industry, or from one industry to another, fueling consumption of CAE software.

*Fundamental transformations in product engineering*

The nature of modern manufactured products is rapidly evolving toward intelligent, connected systems. Once composed solely of mechanical parts, products have become complex systems often combining mechanical hardware, electronics, sensors, controls, software, and communications in myriad ways to monitor and adjust behavior using embedded logic. Advanced driver-assistance systems, or ADAS, autonomous vehicles, or AVs, modern industrial robots and most new consumer products are examples of this new paradigm. This complex interplay across domains is forcing engineers to take a systems-level approach to design, and in turn to rely on advanced computer-aided systems simulation as a necessity in product design. Controls algorithm development, modeling of linked systems, and transfer of control logic into embedded systems can all be done using CAE software to achieve optimal performance and cost and ensure product integrity while minimizing physical prototype iterations.

*Democratization of CAE*

CAE software access was historically limited to a small pool of specialist engineers in large organizations with a high level of domain expertise and knowledge of complex mathematical modeling and underlying physics. Exploring different product design ideas at the same time through simulation software required reliable, secure, and dedicated high-speed computing infrastructure, which was typically expensive to own and operate. The dramatic increase in computing performance, and an equally dramatic reduction in computing cost over the last twenty years coupled with the growth of cloud computing is making CAE, and especially optimization, cost effective. Coupled with user-friendly software applications which make multi-run design studies less expensive, businesses have the opportunity to expand their CAE user community and overall application of simulation.

We believe record numbers of engineers and designers involved in product development now have access to CAE tools, and any one engineer involved in product development has access to more CAE tools than ever, thus driving increased adoption of CAE solutions across large organizations and by small and medium businesses.

*An emerging paradigm of simulation-driven design*

Simulation is now driving design innovation, rather than following design. The product development process of recent decades involved creation of a product concept followed by development of a detailed design using 3D CAD. The designs were then passed along to engineering teams to refine, test and optimize. CAE was often too

late or too slow to effectively impact the rapid decisions required to correct flawed product designs. Design changes late in the product development process are costly, may delay product launches, and can adversely affect product quality and performance.

Democratization of CAE offers product designers easy access to a user-friendly subset of simulation tools to take into account product performance objectives and manufacturability early in the design process. Going forward, engineering specialists can focus more on detailed validations and complex simulations. This is driving a positive movement toward simulation-driven design processes and a corresponding growth in simulation software consumption.

*Expanding scope of simulations to “digital twins”*

The evolution of products into intelligent, connected devices—which are increasingly embedded in broader systems—is reshaping how products are engineered, manufactured, operated and serviced. Smart, connected products underpin the IoT and generate vast amounts of actionable data. As consumers and industries begin to realize tangible benefits from connected products, IoT adoption is accelerating. Gartner estimates that the installed base of IoT units will grow to reach more than 20 billion units by 2020.\*

CAE software combined with advanced analytics and operating data from sensors make it possible for manufacturers to improve product performance through complete life-cycles. In-service measurements, combined with simulation models, or digital twins, provide information to predict and prescribe maintenance of components or systems. The IoT is changing engineering by broadening the scope of PLM to leverage simulation and analytics for better and more robust manufacturing and in-service operation.

**Market opportunity**

Rising expectations of end-market customers, new manufacturing methods such as 3D printing, the ability to design and process composites and new materials, combined with more powerful math-based computational technologies, are expanding the application of simulation across many industry verticals and throughout product life-cycles. CAE software offers companies opportunities to achieve better, lower cost products with fewer physical prototypes and tests, and reduces the time required to bring products to market.

The CIMdata Report forecasts, “the PLM market to grow at a compound annual growth rate (CAGR) of 6.7% to \$56.3 billion” in 2021. The CIMdata Report estimates the CAE market which they refer to as Simulation and Analysis, as a subset of the PLM market to be approximately \$5.3 billion and \$5.7 billion in 2016 and 2017, respectively. The CIMdata Report expects the CAE market, “will be one of the more rapidly growing segments within the tools sector of PLM over the next five years, and forecasts that this market sector will exceed \$7.8 billion in 2021, with an 8.1% CAGR.”

We believe our strategy of making CAE technologies more accessible through simplified user interfaces with easy access to a broad range of applications and new cloud offerings will help us expand to more designers, engineers and architects at larger companies as well as at small and medium enterprises, thus driving a growth rate that exceeds the overall simulation and analysis, or the S&A, market. In addition, our recent offerings including software for math-based systems modeling, embedded systems design, and visual analytics present an opportunity to expand our customer base.

Our addressable opportunity also includes software to facilitate and optimize the use of HPC infrastructure critical for running complex simulation models in industries ranging from manufacturing to weather prediction,

bio-informatics and financial risk-management. According to the former high performance analyst team of IDC which is now owned by Hyperion, the market for high-end HPC servers is estimated to reach \$7 billion by 2020. We believe we are positioned attractively to capture spending related to workload management systems for these high-end servers.

We believe Altair's simulation and HPC expertise uniquely positions us to address a portion of spending in the massive and fast growing IoT and analytics market. IDC estimates that \$36 billion was spent on IoT platforms in 2015, and estimates the market to grow at a CAGR of 15% through 2020. IDC believes \$19.97 billion was spent on business intelligence and analytics software tools in 2016 and will grow at a CAGR of 12% through 2021. We have decades of experience helping our customers aggregate, analyze and visualize vast datasets created by large scale simulations, laboratory tests and in-field sensors. Through our analytics product suite and IoT platform, we are expanding our market reach to a broader set of customers, enabling them to collect and analyze data from an increasing number of connected products to support key business decisions.

## **Competitive strengths**

We believe the following strengths will allow us to maintain and build our position in the growing market for engineering and simulation solutions:

### ***Experienced management and culture of innovation***

As a technology and product driven company, we believe Altair's culture of innovation creates engagement and loyalty among our employees and customers.

Our founder and leadership team are deeply experienced with a strong track record of both business and product innovation. Our diversified and global workforce is highly experienced and energetic. Altair's culture affords many opportunities for people to take on new roles and assignments, including significant mobility between locations around the world. Approximately 50% of our employees have been with Altair more than five years and approximately 50% of our managers have a tenure exceeding ten years. Many of our key executives have worked at the company for over 20 years. All of this translates into a significant competitive advantage through deeply rooted institutional knowledge about our market, our competitors' strengths and weaknesses, and engineering technology.

### ***Units-based subscription licensing model***

Altair pioneered a patented units-based subscription licensing model for software and other digital content which has transformed the way our customers use software, delivering strong retention rates and revenue growth.

Under a traditional software industry licensing model, customers license rights to use a particular application or a suite of applications, which are typically priced on a per user or central processing unit, or CPU, basis for a specified period of time. The Altair units-based subscription licensing model is different from the traditional licensing model because it allows customers to license a pool of units for their organizations, providing individual users flexible access to our entire portfolio of software applications along with over 150 partner products. Under the Altair units-based subscription licensing model, customers acquire rights to use a “unit” for a specified period of time. Units are held in a pool and drawn when a user runs any of the applications available under our licensing model, either Altair applications or third-party partner applications. When the user closes the application, the units are returned to the pool and become available for use by all users. In 2016, customers accessed an average of 14.6 applications from our overall portfolio. Altair’s business model is particularly suited to CAE, as engineers and designers often require several different applications across multiple disciplines when developing products. This model lowers barriers to adoption, creates broad engagement, encourages users to work within our ecosystem and access applications they might otherwise have purchased from competitors, and increases revenue. This, in turn, helps drive our recurring software license rate which has been on average approximately 88% over the past five years. Each year approximately 60% of new revenue comes from expansion within existing customers.

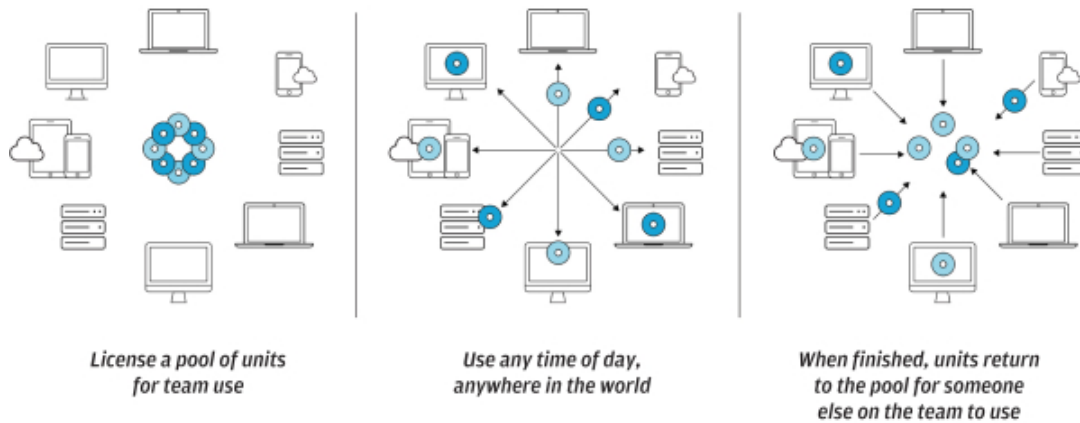

**Broad simulation portfolio and open interfaces**

Altair’s broad portfolio of solutions as well as our open philosophy toward interfacing with other solutions, including competitors, positions us as a strong and strategic partner for customers.

We have assembled one of the broadest portfolios of simulation and optimization applications in the industry, spanning multiple domains and technology disciplines. Our software offers multidisciplinary capabilities in simulation, optimization and predictive analytics. We address the entire product lifecycle including concept design, engineering, manufacturing processes, and in-service operations.

Altair has historically offered broad and complete interfaces to most major third party CAD and CAE software on the market. Customers using a variety of platforms within their enterprises and throughout their supply chain have the ability to use Altair’s software as a central method to share models across multiple formats and between different simulation disciplines.

### ***Industry-leading simulation performance***

Our simulation solutions including modeling, visualization and solvers are noted in the market for their ability to handle large and complex models.

Altair's software applications are highly industrialized and state-of-the-art and take thorough advantage of new compute architectures as they become available including new processors, storage systems, Graphics Processing Units, or GPUs, and on-premise and public high-performance cloud computing. In addition, we are developing and experimenting with solutions for HPC workload management and remote visualization which will allow the delivery of our own as well as other software via a cloud model.

Our software applications deliver high-performance and high scalability, including massive parallelization, which is increasingly important in the CAE market. This allows our customers to run complex high-fidelity simulations quickly and cost-effectively. As the market moves to drive design with numerical optimization and stochastic studies to improve quality, this requires models to be run multiple times, often with hundreds or thousands of changes to input variables. Compute performance and the ability to run larger models are critical to delivering timely and accurate results, and best-in-class designs.

Altair is a leader in integrating optimization technology across all our products including multi-disciplinary applications. We believe our ability to leverage HPC as the industry transitions to cloud computing also provides an important differentiator.

### ***Deep technical engagement with customers***

Our services including consulting, implementation services, training and support enhance our ability to drive grassroots demand for our applications.

Altair's software related services team is comprised of approximately 700 highly technical people globally and is differentiated by its significant size and the breadth of their real world experience. We believe our approach differentiates us from our competitors, as we focus on establishing a strong working relationship with the user community allowing us to offer guidance and expertise throughout their product creation process.

Altair has a philosophy of significant engagement with strategic customers on key development projects in our software product roadmap to ensure we deliver solutions which are innovative and comprehensive in addressing customer requirements.

We believe our close technical engagement with users, along with senior engineering relationships developed by our sales personnel, helps our ability to sell future products and services.

### **Growth strategies**

We believe the following represent opportunities for Altair's growth in the engineering simulation market:

- Grow market share for solvers;
- Grow indirect business through our original equipment manufacturer, or OEM, and reseller networks;
- Establish leadership position in the expanding cloud HPC market;
- Expand client adoption for simulation-driven design offerings; and
- Target the emerging IoT market with platform, analytics and digital twin solutions.

We intend to pursue growth by leveraging these opportunities with the following growth strategies:

***Increase software usage within our existing customer base***

Our existing base of tens of thousands of users across approximately 5,000 customers worldwide provides a significant opportunity to increase revenues. Historically we have derived 60% of our new software revenue from existing clients. The units-based subscription licensing model lowers barriers to usage, and provides customers the flexibility to initially deploy one or more of our products and later expand usage to more of our applications along with partner products. This land and expand strategy combined with our leadership position in modeling and visualization and our strong portfolio of solver products presents a clear path toward increased usage.

We believe Altair PBS Cloud, complemented by the newly acquired Runtime Design Automation, or Runtime, products, can revolutionize how customer organizations manage their on-premises HPC computing and off-premises cloud infrastructure. As companies transition more HPC workloads to the cloud, we believe Altair PBS Cloud along with Runtime will help them to easily provision, manage and optimize these resources to maximize return on investment.

***Invest in our direct sales force***

Our direct sales force is highly technical and experienced, and consistently delivers solid growth and customer loyalty. Our subscription business model sometimes results in smaller new and expansion deal sizes than traditional paid-up licensing approaches. However, our model drives recurring software licenses and consistent growth, creates broad engagement, encourages users to work within our ecosystem, and increases revenue. This drives our recurring software license rate which has been on average approximately 88% over the past five years, and is powerful when competing for new business.

We plan to hire additional field and inside sales professionals in most major markets in which we operate, and to support these teams with continued brand and product marketing. We believe adding sales capacity in our direct sales force will grow revenue.

***Expand through indirect sales channels***

We believe there is growth and margin expansion opportunity through our OEM and reseller networks, and we plan to continue adding more partners across all product suites in the future.

solidThinking indirect channels are intended to deliver important new top line growth into middle-market companies not requiring the full suite of enterprise solutions. We plan to focus significant attention on growing our base of Carriots OEMs, implementation partners, and resellers by targeting specific vertical IoT markets. These relationships are important in creating opportunities for digital twin simulation related to the design of, and in-service predictive analytics of, connected products.

***Continue investment in R&D***

We organically developed over 15 products which came to market commercially in the last 25 years. These include HyperMesh, HyperView, HyperGraph, OptiStruct, Compose, Activate, Click2Form, HyperStudy, Inspire, MotionView, MotionSolve, Altair PBS Access, Altair PBS Cloud, and Carriots Analytics. We believe this level of organic product creation sustained over such a long period of time is unique in the PLM market.

Analytics from our units-based subscription licensing model gives us insight into our customers' workflows and usage patterns. This helps guide our product development and R&D efforts. We pay attention to how problems are being solved by currently available solutions and look for opportunities to create new products where we

can make significant improvements in quality or performance and deliver future revenue streams for our company. We experiment with new methods and emerging technologies as they become available to learn and to find ways they can be relevant in advancing our products' technologies in the markets we serve.

We view our continued investment in R&D as essential to developing new products and technologies, as well as new features for existing products, to support the needs of our users.

#### ***Selectively pursue acquisitions and strategic investments***

We plan to explore and pursue selective acquisitions and strategic investments to complement and strengthen our product offerings, expand the functionality of our solution, acquire technology or talent, or gain access to new customers and markets.

We acquired 19 companies or strategic technologies since 1996, including 11 in the last three years. These acquisitions brought strategic IP assets, and approximately 200 developers with expertise in disciplines ranging from electronics, material science, crash and safety to industrial design and rendering. Products which are commercially available as a result of these acquisitions include Click2Extrude, Altair PBS Professional, Radioss, Evolve, Acusolve, SimLab, Embed, Click2Cast, Multi-scale Designer, FEKO, FLUX, WinProp, Thea Render, Modellis, Carriots, and ESAComp.

We believe our ability to integrate expert teams and new IP into our organization, and quickly bring acquired products to market with our business model, is unique in the PLM market.

#### **Subsequent events**

On September 28, 2017, we acquired Runtime for \$10.0 million in cash, \$8.7 million in a deferred cash payment obligation, and 708,000 shares of our Class A voting common stock. Runtime complements Altair's PBS Works™ suite of products for comprehensive, secure workload management for HPC and cloud environments and has solutions to manage highly complex workflows. We believe both Runtime and PBS Works deliver innovative and mission critical technology to optimize the use of HPC for compute-intensive applications. PBS Works targets product design, weather prediction, oil exploration and bio-informatics, and Runtime primarily serves customers in electronic design automation, or EDA.

#### **Risks affecting us**

Our business is subject to numerous risks and uncertainties, including those highlighted in the section entitled "Risk factors" immediately following this prospectus summary. These risks include, but are not limited to, the following:

- We have experienced significant revenue growth and we may fail to sustain that growth rate or may not grow in the future;
- If we cannot maintain our company culture of innovation, teamwork, and communication our business may be harmed;
- If our existing customers or users do not increase their usage of our software, or we do not add new customers, the growth of our business may be harmed;
- Our ability to acquire new customers is difficult to predict because our software sales cycle can be long;
- Reduced spending on product design and development activities by our customers may negatively affect our revenues;

- Our business largely depends on annual renewals of our software licenses;
- We believe our future success will depend, in part, on the growth in demand for our software by customers other than simulation engineering specialists and in additional industry verticals;
- We face significant competition, which may adversely affect our ability to add new customers, retain existing customers and grow our business;
- Because we derive a substantial portion of our revenues from customers in the automotive industry, we are susceptible to factors affecting this industry;
- Our quarterly results may fluctuate significantly and may not fully reflect the underlying performance of our business; and
- The dual class structure of our common stock has the effect of concentrating voting control with certain stockholders who hold shares of our Class B common stock, including our founders, certain of our directors and executive officers and affiliates, who will hold in the aggregate % of the voting power of our capital stock following the completion of this offering. This will limit or preclude your ability to influence corporate matters, including the election of directors, amendments of our organizational documents, and any merger, consolidation, sale of all or substantially all of our assets, or other major corporate transaction requiring stockholder approval. Upon the completion of this offering, our executive officers, directors and current beneficial owners of 5% or more of our Class A common stock, together with their respective affiliates, will beneficially own, in the aggregate, approximately % of our outstanding common stock, assuming no exercise of the underwriters' option to purchase additional shares of our common stock in this offering.

### **Corporate history and information**

We were incorporated in Michigan in 1985. We became a Delaware corporation in October 2017. Our principal executive offices are located at 1820 E. Big Beaver Road, Troy, Michigan 48083. On April 3, 2017, we completed a recapitalization of our capital stock by filing a certificate of amendment to our articles of incorporation with the State of Michigan pursuant to which: (i) each share of our Class A voting common stock, or our old Class A shares, automatically converted into one share of new Class B voting common stock entitled to ten votes per share; and (ii) each share of our Class B non-voting common stock, or our old Class B shares, automatically converted into one share of new Class A voting common stock entitled to one vote per share, in each case, without any further action on the part of the holders thereof. We refer to this transaction as our "Recapitalization." Our website address is [www.altair.com](http://www.altair.com). Information contained on our website is not incorporated by reference into this prospectus, and you should not consider any information contained on, or that can be accessed through, our website as part of this prospectus or in deciding whether to purchase shares of our Class A common stock.

Unless the context otherwise requires, the terms "Altair," "the Company," "we," "us" and "our" in this prospectus refers to Altair Engineering Inc. and its subsidiaries. The Altair design logo and the marks "OptiStruct," "RADIOSS," "AcuSolve," "FEKO," "Flux," "WinProp," "Multiscale Designer," "HyperStudy," "HyperMesh," "HyperView," "SimLab," "HyperCrash," "HyperGraph," "Inspire," "solidThinking Evolve," "Thea Render," "Click2Cast," "Click2Extrude," "Click2Form," "Carriots," "solidThinking Compose," "solidThinking Activate," "solidThinking Embed," "Altair PBS Works," "Altair PBS Professional," "Altair PBS Cloud," "MotionView," "MotionSolve," "Altair PBS Access" and our other registered or common law trade names, trademarks or service marks appearing in this prospectus are our property. This prospectus contains additional trade names, trademarks and service marks of other companies that are the property of their respective



owners. We do not intend our use or display of other companies' trade names, trademarks or service marks to imply a relationship with, or endorsement or sponsorship of us by these other companies.

### **Implications of being an emerging growth company**

We qualify as an "emerging growth company" as defined in the Jumpstart Our Business Startups Act of 2012, as amended, or the JOBS Act. An emerging growth company may take advantage of relief from certain reporting requirements and other burdens that are otherwise applicable generally to public companies. These provisions include:

- reduced obligations with respect to financial data, including presenting only two years of audited financial statements and only two years of selected financial data;
- an exemption from compliance with the auditor attestation requirements of Section 404 of the Sarbanes-Oxley Act of 2002, as amended, or SOX;
- reduced disclosure about our executive compensation arrangements;
- an exemption from the requirements to obtain a nonbinding advisory vote on executive compensation or stockholder approval of any golden parachute arrangements; and
- extended transition period for complying with new and revised accounting standards that have different effective dates for public and private companies until the earlier of the date we (i) are no longer an emerging growth company, or (ii) affirmatively and irrevocably opt out of the extended transition period provided in the JOBS Act.

We may take advantage of these provisions for up to five years or such earlier time that we no longer qualify as an emerging growth company. We would cease to be an emerging growth company if we have more than \$1.07 billion in annual revenues, have more than \$700 million in market value of our capital stock held by non-affiliates or issue more than \$1.0 billion of non-convertible debt over a three-year period. We may choose to take advantage of some but not all of these reduced reporting burdens.

## The offering

<b>Class A common stock offered by us</b>	shares
<b>Class A common stock offered by the selling stockholders</b>	shares
<b>Overallotment option offered by us</b>	shares
<b>Class A common stock to be outstanding after this offering</b>	shares ( shares, if the underwriters exercise their option to purchase additional shares in full)
<b>Class B common stock to be outstanding after this offering</b>	shares
<b>Total Class A and Class B common stock to be outstanding after this offering</b>	shares ( shares, if the underwriters exercise their option to purchase additional shares in full)
<b>Use of proceeds</b>	<p>We estimate that the net proceeds from our sale of shares of Class A common stock in this offering at an assumed initial public offering price of \$ per share, the midpoint of the price range set forth on the front cover of this prospectus, after deducting estimated underwriting discounts and commissions and estimated offering expenses, will be approximately \$ million, or \$ million if the underwriters' overallotment option is exercised in full.</p> <p>We intend to use the net proceeds of this offering to (i) repay our term loan and our revolving credit facility balance under our Credit Agreement, and (ii) pay the origination fees and expenses related to our new revolving credit facility, or New Credit Facility. We intend to use the remaining net proceeds to us for general corporate purposes, including real estate development, working capital, sales and marketing activities, general and administrative matters, capital expenditures, and acquisitions, or investments in, technologies or businesses.</p> <p>We will not receive any proceeds from the sale of shares of our Class A common stock by the selling stockholders.</p> <p>For a more complete description of our intended use of proceeds from this offering, see the section entitled "Use of proceeds."</p>
<b>Proposed symbol</b>	"ALTR"
<b>Voting Rights</b>	Shares of our Class A common stock are entitled to one vote per share. Shares of our Class B common stock are entitled to ten votes per share. Holders of our Class A common stock and Class B common stock will generally vote together as a single class, unless otherwise

required by law or by our Delaware certificate of incorporation. The holders of our outstanding Class B common stock will hold approximately % of the voting power of our outstanding capital stock following this offering and will have the ability to control the outcome of matters submitted to our stockholders for approval, including the election of our directors and the approval of any change in control transaction. See the sections entitled “Principal and selling stockholders” and “Description of capital stock” for additional information.

**Conflicts of Interest**

Affiliates of J.P. Morgan Securities LLC and RBC Capital Markets, LLC, the joint book running managers for this offering, will receive more than 5% of the net proceeds of this offering in connection (i) with the repayment of outstanding loans under our Credit Agreement and (ii) the receipt of origination fees and expenses related to the New Credit Facility. Accordingly, this offering is being conducted in accordance with the applicable provisions of Rule 5121 of the Financial Industry Authority, Inc., or FINRA, Conduct Rules because certain of the underwriters will have a “conflict interest” pursuant to Rule 5121. In accordance with Rule 5121, Deutsche Bank Securities Inc. is acting as the qualified independent underwriter in this offering. Any underwriter that has a conflict of interest pursuant to Rule 5121 will not confirm sales to accounts in which it exercises discretionary authority without the prior written consent of the customer. See the section entitled “Underwriting—Conflicts of interest.”

The total number of shares of our common stock to be outstanding following this offering is based on 9,387,512 shares of our Class A common stock and 41,203,428 shares of our Class B common stock, outstanding as of June 30, 2017, and excludes:

- 6,207,976 shares of our Class A common stock to be reserved for issuance under our 2017 Equity Incentive Plan, or our 2017 Plan;
- 2,627,920 shares of our Class A common stock reserved for issuance under our 2012 Incentive and Non-Qualified Stock Option Plan, or our 2012 Plan;
- 6,347,840 shares of our Class A common stock issuable upon exercise of stock options outstanding as of June 30, 2017, with an exercise price of \$0.000025, under our 2001 Non-Qualified Stock Option Plan, or our 2001 NQSO Plan;
- 2,931,380 shares of our Class A common stock issuable upon exercise of stock options outstanding as of June 30, 2017, with a weighted average exercise price of \$0.64, under our 2001 Incentive and Non-Qualified Stock Option Plan, or 2001 ISO and NQSO Plan (other than the stock options to be exercised by certain of the selling stockholders in connection with this offering, as set forth elsewhere in this prospectus); and
- 2,209,608 shares of our Class A common stock issuable upon exercise of stock options outstanding as of June 30, 2017, with a weighted average exercise price of \$3.73, under our 2012 Plan.

Except as otherwise indicated, all information in this prospectus assumes:

- no exercise or cancellations of outstanding stock options after June 30, 2017 (except by certain of the selling stockholders in connection with this offering, as disclosed elsewhere in this prospectus);
- no exercise by the underwriters of their option to purchase up to an additional                      shares of our Class A common stock; and
- a four-for-one stock split of our common stock which became effective in October 2017.

## **Summary historical consolidated financial and other data**

The following tables summarize the consolidated financial data for our business. You should read this summary consolidated financial data in conjunction with the "Management's discussion and analysis of financial condition and results of operations" and our consolidated financial statements and related notes included elsewhere in this prospectus. We derived the consolidated statements of operations data for the years ended December 31, 2015 and 2016 and the consolidated balance sheet data as of December 31, 2016, from our audited consolidated financial statements included elsewhere in this prospectus. The consolidated statement of operations and cash flow data for the six months ended June 30, 2016 and 2017, and the consolidated balance sheet data as of June 30, 2017, are derived from our unaudited consolidated financial statements included elsewhere in this prospectus. We have prepared the unaudited consolidated financial statements on the same basis as the audited consolidated financial statements and have included all adjustments, consisting only of normal recurring adjustments that, in our opinion, are necessary to state fairly the financial information set forth in those statements. Our historical results are not necessarily indicative of the results that may be expected in the future, and the results of operations for the six months ended June 30, 2017 are not necessarily indicative of the results to be expected for the full fiscal year or any other period. The summary consolidated financial data in this section are not intended to replace our consolidated financial statements and the related notes, and are qualified in their entirety by the consolidated financial statements and related notes included elsewhere in this prospectus.

(in thousands, except share data)	Years ended December 31,		Six months ended June 30,	
	2015	2016	2016	2017
<b>Consolidated statements of operations data:</b>				
Revenue:				
Software	\$205,567	\$223,818	\$106,929	\$113,697
Software related services	37,294	35,770	17,790	17,175
Total software	242,861	259,588	124,719	130,872
Client engineering services	45,075	47,702	24,289	24,594
Other	6,193	5,950	3,332	3,062
Total revenue	294,129	313,240	152,340	158,528
Cost of revenue:				
Software <sup>(1)</sup>	27,406	31,962	15,021	17,633
Software related services	30,079	27,653	13,838	13,773
Total software	57,485	59,615	28,859	31,406
Client engineering services	36,081	38,106	19,207	19,969
Other	5,642	4,879	2,692	2,297
Total cost of revenue	99,208	102,600	50,758	53,672
Gross profit	194,921	210,640	101,582	104,856
Operating expenses:				
Research and development <sup>(1)</sup>	62,777	71,325	34,012	41,608
Sales and marketing <sup>(1)</sup>	63,080	66,086	32,093	36,338
General and administrative <sup>(1)</sup>	54,069	57,202	27,882	37,290
Amortization of intangible assets	2,624	3,322	1,477	2,098
Other operating income	(2,576)	(2,742)	(1,129)	(3,330)
Total operating expense	179,974	195,193	94,335	114,004
Operating income (loss)	14,947	15,447	7,247	(9,148)
Interest expense	2,416	2,265	1,247	1,159
Other expense (income), net	782	(520)	(652)	786
Income (loss) before income taxes	11,749	13,702	6,652	(11,093)
Income tax expense (benefit)	818	3,539	2,699	(1,659)
Net income (loss)	\$ 10,931	\$ 10,163	\$ 3,953	\$ (9,434)
Net income (loss) per share attributable to common stockholders, basic <sup>(2)</sup>	\$ 0.23	\$ 0.21	\$ 0.08	\$ (0.19)
Net income (loss) per share attributable to common stockholders, diluted <sup>(2)</sup>	\$ 0.19	\$ 0.18	\$ 0.07	\$ (0.19)
Weighted average number of shares used in computing net income (loss) per share, basic <sup>(2)</sup>	46,609	48,852	47,891	50,255
Weighted average number of shares used in computing net income (loss) per share, diluted <sup>(2)</sup>	58,709	57,856	57,236	50,255
Pro forma net income (loss) <sup>(3)</sup>		\$ 12,341		\$ (3,303)
Pro forma net income (loss) per share attributable to common stockholders, basic <sup>(3)</sup>		\$ 0.25		\$ (0.07)
Pro forma net income (loss) per share attributable to common stockholders, diluted <sup>(3)</sup>		\$ 0.21		\$ (0.07)
Other financial information:				
Net cash provided by operating activities	\$ 10,838	\$ 21,385	\$ 22,006	\$ 26,117

## Table of Contents

(1) Includes stock-based compensation expense as follows:

(in thousands)	Year ended December 31,		Six months ended June 30,	
	2015	2016	2016	2017
Cost of revenue—software	\$ 44	\$ 22	\$ 14	\$ 16
Research and development	149	1,370	41	3,784
Sales and marketing	109	775	35	2,115
General and administrative	295	2,965	85	8,122
<b>Total stock-based compensation expense</b>	<b>\$597</b>	<b>\$5,132</b>	<b>\$175</b>	<b>\$14,037</b>

(2) See Note 14 to our consolidated financial statements for an explanation of the method used to calculate basic and diluted net income (loss) per share attributable to common stockholders.

(3) The Pro forma amounts reflect the effects of the reversal of the stock-based compensation liability that will occur upon effectiveness (see Note 3 to our consolidated financial statements), but excludes the 708,000 shares of our Class A common stock issued on September 28, 2017 in connection with our acquisition of Runtime.

(in thousands)	As of June 30, 2017		
	Actual	Pro forma <sup>(1)</sup>	Pro forma as adjusted <sup>(2)(3)</sup>
<b>Consolidated balance sheet data:</b>			
Cash and cash equivalents	\$ 17,419	\$ 17,419	
Working capital	(79,313)	(79,313)	
Total assets	265,610	265,610	
Deferred revenue, current and non-current	136,780	136,780	
Debt	71,095	71,095	
<b>Total stockholders' deficit</b>	<b>(41,434)</b>	<b>(24,583)</b>	

(1) The Pro forma column in the consolidated balance sheet data table above reflects the effects of the reversal of the stock-based compensation liability that will occur upon effectiveness of the registration statement of which this prospectus is a part, as if it had occurred on June 30, 2017 (See Note 3 to our consolidated financial statements), and the four-for-one stock split of our common stock effective when we became a Delaware corporation on October 5, 2017, but excludes the 708,000 shares of our Class A common stock issued on September 28, 2017 in connection with our acquisition of Runtime.

(2) The Pro forma as Adjusted column gives effect to (i) the pro forma adjustments set forth above, (ii) the receipt by us of \$ million in net proceeds from the sale and issuance by us of shares of our Class A common stock offered in this prospectus at an assumed initial public offering price of \$ per share, which is the midpoint of the range set forth on the cover page of this prospectus, after deducting the estimated underwriting discounts and commissions from this offering and estimated offering expenses paid or payable by us and, (iii) our use of a portion of our net proceeds from this offering to fully repay our term loan and revolving credit facility balance under our Credit Agreement, which had outstanding balances of \$52.5 million and \$18.0 million, respectively, as of June 30, 2017.

(3) Each \$1.00 increase or decrease in the assumed initial public offering price of \$ per share, which is the midpoint of the range set forth on the cover page of this prospectus, would increase or decrease, as applicable, the pro forma as adjusted cash and cash equivalents, working capital, total assets, and total stockholders' deficit by \$ million, assuming that the number of shares offered by us, as set forth on the cover page of this prospectus, remains the same, and after deducting estimated underwriting discounts and commissions from this offering. The pro forma as adjusted information presented in the consolidated balance sheet data is illustrative only and will change based on the actual initial public offering price and other terms of this offering determined at pricing.

## Key metrics

We monitor the following key non-GAAP, (United States generally accepted accounting principles), financial and operating metrics to help us evaluate our business, measure our performance, identify trends affecting our business, formulate business plans and make strategic decisions. In addition to our results determined in accordance with GAAP, we believe the following non-GAAP financial and operating metrics are useful in evaluating our operating performance.

**Billings.** Billings consists of our total revenue plus the change in our deferred revenue in a given period. As we generally bill our customers at the time of sale, but typically recognize a majority of the related revenue ratably

over time, management believes that Billings is a meaningful way to measure and monitor our ability to provide our business with the working capital generated by upfront payments from our customers. While we believe that billings provides valuable insight into the cash that will be generated from sales of our software and services, this metric may vary from period-to-period for a number of reasons including the impact of changes in foreign currency exchange rates and the potential impact of acquisitions. See the section entitled “Selected historical consolidated financial and other data—Reconciliation of non-GAAP financial measures” for information regarding the limitations of using Billings as a financial measure and for a reconciliation of Billings to revenue, the most directly comparable financial measure calculated in accordance with GAAP.

Our Billings were as follows:

(in thousands)	Year ended December 31,		Six months ended June 30,	
	2015	2016	2016	2017
Billings	\$297,358	\$320,653	\$165,449	\$181,379

*Adjusted EBITDA.* We define Adjusted EBITDA as net income (loss) adjusted for income tax expense (benefit), interest expense, interest income and other, depreciation and amortization, stock-based compensation expense, restructuring charges, asset impairment charges and other special items as determined by management. We believe that Adjusted EBITDA is a meaningful measure of performance as it is commonly utilized by us and the investment community to analyze operating performance in our industry. See the section entitled “Selected historical consolidated financial and other data—Reconciliation of non-GAAP financial measures” for information regarding the limitations of using Adjusted EBITDA as a financial measure and for a reconciliation of Adjusted EBITDA to net income (loss), the most directly comparable financial measure calculated in accordance with GAAP.

Our Adjusted EBITDA was as follows:

(in thousands)	Year ended December 31,		Six months ended June 30,	
	2015	2016	2016	2017
Adjusted EBITDA	\$22,949	\$30,830	\$12,933	\$7,056

*Free Cash Flow.* Free Cash Flow is a non-GAAP financial measure that we calculate as cash flow provided by operating activities less capital expenditures. We believe that Free Cash Flow is useful in analyzing our ability to service and repay debt and return value directly to stockholders. See the section entitled “Selected historical consolidated financial and other data—Reconciliation of non-GAAP financial measures” for information regarding the limitations of using Free Cash Flow as a financial measure and for a reconciliation of Free Cash Flow to net cash provided by operating activities, the most directly comparable financial measure calculated in accordance with GAAP.

Our Free Cash Flow was as follows:

(in thousands)	Year ended December 31,		Six months ended June 30,	
	2015	2016	2016	2017
Free Cash Flow	\$5,605	\$11,941	\$18,307	\$21,782

*Recurring Software License Rate.* A key factor to our success is our recurring software license rate which we measure through billings, primarily derived from annual renewals of our existing subscription customer



agreements. We calculate our recurring software license rate for a particular period by dividing (i) the sum of software term-based license billings, software license maintenance billings, and 20% of software perpetual license billings which we believe approximates maintenance as an element of the arrangement by (ii) the total software license billings including all term-based, maintenance, and perpetual license billings from all customers for that period. For the years ended December 31, 2015, 2016 and six months ended June 30, 2017, our recurring software license rate was 88%, 90% and 91%, respectively.

## Risk factors

*Investing in our Class A common stock involves a high degree of risk. You should carefully consider the risks and uncertainties described below, together with all the other information in this prospectus, including “Management’s discussion and analysis of financial condition and results of operations” and our consolidated financial statements and the notes related thereto, before investing in our Class A common stock. The risks and uncertainties described below are not the only ones we face. Additional risks and uncertainties that we are unaware of, or that we currently believe are not material, may also become important factors that affect our business. If any of the following risks occur, our business, financial condition, operating results and prospects could be materially harmed. In that event, the trading price of our Class A common stock could decline, and you could lose part or all of your investment.*

### Risks relating to our business and industry

***We have experienced significant revenue growth and we may fail to sustain that growth rate or may not grow in the future.***

We were founded in 1985 and launched our first commercial software in 1990. Our growth has primarily been attributed to the increasing reliance of manufacturers on our simulation and optimization software to support development of their products and designs. Revenue from our software segment has historically constituted a significant portion of our total revenue. Our revenue growth could decline over time as a result of a number of factors, including increasing competition from smaller entities and well-established, larger organizations, limited ability to, or our decision not to, increase pricing, contraction of our overall market or our failure to capitalize on growth opportunities. Other factors include managing our global organization, revenues generated outside the United States that are subject to adverse currency fluctuations and uncertain international geopolitical landscapes. In connection with operating as a public company, we will also incur additional legal, accounting and other expenses that we did not incur as a private company. Accordingly, we may not achieve similar growth rates in future periods, and you should not rely on our historical revenue growth as an indication of our future revenue or revenue growth.

***If we cannot maintain our company culture of innovation, teamwork, and communication our business may be harmed.***

We believe that a critical component to our success has been our company culture, which is based on our core values of innovation, envisioning the future, communicating honestly and broadly, seeking technology and business firsts, and embracing diversity. We have invested substantial time and resources in building a company embodying this culture. As we develop the infrastructure of a public company and continue to grow, we may find it difficult to maintain these valuable aspects of our corporate culture. Any failure to preserve our culture could negatively impact our future success, including our ability to attract and retain personnel, encourage innovation and teamwork, and effectively focus on and pursue our corporate objectives.

***If our existing customers or users do not increase their usage of our software, or we do not add new customers, the growth of our business may be harmed.***

Our software includes a multitude of broad and deep design, simulation, optimization, and analysis applications and functionalities.

Our future success depends, in part, on our ability to increase the:

- number of customers and users accessing our software;

## [Table of Contents](#)

- usage of our software to address expanding design, engineering, computing and analytical needs; and/or
- number of our applications and functionalities accessed by users and customers through our licensing model.

In addition, through our Altair Partner Alliance, or APA, our customers have access to additional software offered by independent third parties, without the need to enter into additional license agreements.

If we fail to increase the number of customers or users and/or application usage among existing users of our software and the software of our APA partners, our ability to license additional software will be adversely affected, which would harm our operating results and financial condition.

### ***Our ability to acquire new customers is difficult to predict because our software sales cycle can be long.***

Our ability to increase revenue and maintain or increase profitability depends, in part, on widespread acceptance of our software by mid- to large-size organizations worldwide. We face long, costly, and unpredictable sales cycles. As a result of the variability and length of the sales cycle, we have only a limited ability to forecast the timing of sales. A delay in or failure to complete sales could harm our business and financial results, and could cause our financial results to vary significantly from period to period. Our sales cycle varies widely, reflecting differences in potential customers' decision making processes, procurement requirements and budget cycles, and is subject to significant risks over which we have little or no control, including:

- longstanding use of competing products and hesitancy to change;
- customers' budgetary constraints and priorities;
- timing of customers' budget cycles;
- need by some customers for lengthy evaluations;
- hesitation to adopt new processes and technologies;
- length and timing of customers' approval processes; and
- development of software by our competitors perceived to be equivalent or superior to our software.

To the extent any of the foregoing occur, our average sales cycle may increase and we may have difficulty acquiring new customers.

### ***Reduced spending on product design and development activities by our customers may negatively affect our revenues.***

Our revenues are largely dependent on our customers' overall product design and development activities, particularly demand from mid- to large-size organizations worldwide and their supplier base. The licensing of our software is discretionary. Our customers may reduce their research and development budgets, which could cause them to reduce, defer, or forego licensing of our software. To the extent licensing of our software is perceived by existing and potential customers to be extraneous to their needs, our revenue may be negatively affected by our customers' delays or reductions in product development research and development spending. Customers may delay or cancel software licensing or seek to lower their costs. Deterioration in the demand for product design and development software for any reason would harm our business, operating results, and financial condition in the future.

***Our business largely depends on annual renewals of our software licenses.***

We typically license our software to our customers on an annual basis. In order for us to maintain or improve our operating results, it is important that our customers renew and/or increase the amount of software licensed on an annual basis. Customer renewal rates may be affected by a number of factors, including:

- our pricing or license term and those of our competitors;
- our reputation for performance and reliability;
- new product releases by us or our competitors;
- customer satisfaction with our software or support;
- consolidation within our customer base;
- availability of comparable software from our competitors;
- effects of global or industry specific economic conditions;
- our customers' ability to continue their operations and spending levels; and
- other factors, a number of which are beyond our control.

If our customers fail to renew their licenses or renew on terms that are less beneficial to us, our renewal rates may decline or fluctuate, which may harm our business.

***We believe our future success will depend, in part, on the growth in demand for our software by customers other than simulation engineering specialists and in additional industry verticals.***

Historically, our customers have been simulation engineering specialists. To enable concept engineering, driven by simulation, we make our physics solvers more accessible to designers by wrapping them in powerful simple interfaces. We believe our future success will depend, in part, on growth in demand for our software by these designers, which could be negatively impacted by the lack of:

- continued and/or growing reliance on software to optimize and accelerate the design process;
- adoption of simulation technology by designers other than simulation engineering specialists;
- continued proliferation of mobility, large data sets, cloud computing and IoT; our ability to predict demands of designers other than simulation engineering specialists and achieve market acceptance of our products within these additional areas and customer bases or in additional industry verticals; or
- our ability to respond to changes in the competitive landscape, including whether our competitors establish more widely adopted products for designers other than simulation engineering specialists.

If some or all of this software does not achieve widespread adoption, our revenues and profits may be adversely affected.

***We face significant competition, which may adversely affect our ability to add new customers, retain existing customers, and grow our business.***

The market for CAE software is highly fragmented but has been undergoing significant consolidation. Our primary competitors include Dassault Systèmes, Siemens, Ansys and MSC Software. Dassault and Siemens are large public companies, with significant financial resources, which have historically focused on CAD and product data management. More recently, these two companies have been investing in simulation software through acquisitions. Ansys and MSC are focused on CAE. In addition to these competitors, we compete with many smaller companies offering CAE software applications.

## [Table of Contents](#)

A significant number of companies have developed or are developing software and services that currently, or in the future may, compete with some or all of our software and services. We may also face competition from participants in adjacent markets, including two-dimensional, or 2D, and 3D, CAD, and broader PLM competitors, that may enter our markets by leveraging related technologies and partnering with or acquiring other companies.

The principal competitive factors in our industry include:

- breadth, depth and integration of software;
- domain expertise of sales and technical support personnel;
- consistent global support;
- performance and reliability; and
- price.

Many of our current and potential competitors have longer-term and more extensive relationships with our existing and potential customers that provide them with an advantage in competing for business with those customers. They may be able to devote greater resources to the development and improvement of their offerings than we can. These competitors could incorporate additional functionality into their competing products from their wider product offerings or leverage their commercial relationships in a manner that uses product bundling or closed technology platforms to discourage enterprises from purchasing our applications.

Many existing and potential competitors enjoy competitive advantages over us, such as:

- larger sales and marketing budgets and resources;
- access to larger customer bases, which often provide incumbency advantages;
- broader global distribution and presence;
- greater resources to make acquisitions;
- the ability to bundle competitive offerings with other software and services;
- greater brand recognition;
- lower labor and development costs;
- greater levels of aggregate investment in research and development;
- larger and more mature intellectual property portfolios; and
- greater financial, technical, management and other resources.

These competitive pressures in our markets or our failure to compete effectively may result in fewer customers, price reductions, licensing of fewer units, increased sales and marketing expenses, reduced revenue and gross profits and loss of market share. Any failure to address these factors could harm our business.

***Because we derive a substantial portion of our revenues from customers in the automotive industry, we are susceptible to factors affecting this industry.***

The automotive industry accounted for approximately 50% of our total revenue for the year ended December 31, 2016. An adverse occurrence, including industry slowdown, recession, political instability, costly

## [Table of Contents](#)

or constraining regulations, excessive inflation, prolonged disruptions in one or more of our customers' production schedules or labor disturbances, that results in significant decline in the volume of sales in this industry, or in an overall downturn in the business and operations of our customers in this industry, could adversely affect our business.

The automotive industry is highly cyclical in nature and sensitive to changes in general economic conditions, consumer preferences and interest rates. Any weakness in demand in this industry, the insolvency of a manufacturer or suppliers, or constriction of credit markets may cause our automotive customers to reduce their amount of software licensed or services requested or request discounts or extended payment terms, any of which may cause fluctuations or a decrease in our revenues and timing of cash flows.

***Our quarterly results may fluctuate significantly and may not fully reflect the underlying performance of our business.***

Our quarterly results of operations and our key metrics, including billings, Adjusted EBITDA and Free Cash Flow may vary significantly in the future. Period-to-period comparisons of our operating results may not be meaningful. The results of any one quarter should not be relied upon as an indication of future performance. Our quarterly financial results and key metrics may fluctuate as a result of a variety of factors including:

- our ability to retain and/or increase sales to existing customers at various times;
- our ability to attract new customers;
- the addition or loss of large customers, including through their acquisitions or industry consolidations;
- the timing of recognition of revenues;
- the amount and timing of billings;
- the amount and timing of operating expenses and capital expenditures;
- significant security breaches, technical difficulties or unforeseen interruptions to the functionality of our software;
- the number of new employees added;
- the amount and timing of billing for professional services engagements;
- the timing and success of new products, features, enhancements or functionalities introduced by us or our competitors;
- changes in our pricing policies or those of our competitors;
- changes in the competitive dynamics of our industry, including consolidation among competitors;
- the timing of expenses related to the development or acquisition of technology;
- any future charges for impairment of goodwill from acquired companies;
- extraordinary expenses such as litigation or other dispute-related settlement payments;
- the impact of new accounting pronouncements; and
- general economic conditions.

## [Table of Contents](#)

Billings have historically been highest in the first and fourth quarters of any calendar year and may vary in future quarters. This seasonality or the occurrence of any of the factors above may cause our results of operations to vary and our financial statements may not fully reflect the underlying performance of our business.

In addition, we may choose to grow our business for the long-term rather than to optimize for profitability or cash flows for a particular shorter term period. If our quarterly results of operations fall below the expectations of investors or securities analysts the price of our Class A common stock could decline and we could face lawsuits, including securities class action suits.

### ***Seasonal variations in the purchasing patterns of our customers may lead to fluctuations in the timing of our cash flows.***

We have experienced and expect to continue to experience seasonal variations in the timing of customers' purchases of our software and services. Many customers make purchase decisions based on their fiscal year budgets, which often coincide with the calendar year. These seasonal trends materially affect the timing of our cash flows, as license fees become due at the time the license term commences based upon agreed payment terms that customers may not adhere to. As a result, new and renewal licenses have been concentrated in the first and fourth quarter of the year, and our cash flows from operations have been highest late in the first quarter and early in the second quarter of the succeeding fiscal year.

### ***In connection with the preparation of our consolidated financial statements in recent years, we and our independent registered public accounting firm identified material weaknesses in our internal control over financial reporting. If we are not able to remediate the material weaknesses and otherwise maintain an effective system of internal control over financial reporting, the reliability of our financial reporting, investor confidence in us and the value of our common stock could be adversely affected.***

As a public company, we will be required to maintain internal control over financial reporting and to report any material weaknesses in such internal controls. Section 404 of SOX, or Section 404, requires that we evaluate and determine the effectiveness of our internal controls over financial reporting and, beginning with our second annual report following this offering, provide a management report on internal control over financial reporting. A material weakness is a deficiency, or combination of deficiencies, in internal control over financial reporting such that there is a reasonable possibility that a material misstatement of annual or interim financial statements will not be prevented or detected and corrected on a timely basis.

In connection with the audits of fiscal years 2015 and 2016 financial statements, we and our independent registered public accounting firm identified two material weaknesses in our internal controls over financial reporting. The first material weakness pertained to controls over accounting for income taxes. Specifically, that: (i) certain misstatements were either not identified by management or were not identified timely by management; (ii) the preparation of the consolidation provision and various technical accounting analysis were not prepared or reviewed timely; and (iii) additional technical resources were necessary to enable timely and sufficient review controls over accounting for income taxes. We have taken steps to remediate this by hiring additional technical resources and increasing management review and oversight over the income tax process.

Also in connection with our audits of the fiscal year 2015 and 2016 consolidated financial statements, we and our independent registered public accounting firm identified a second material weakness related to the lack of timely preparation and review of our consolidated financial statements and related disclosures consistent with the requirements for a publicly traded company. Specifically that our internal controls over the financial statement close process were not designed to be precise enough to detect a material error in the financial statements in a timely manner. We have taken steps to remediate this material weakness, by hiring additional personnel and increasing management review and oversight over the financial statement close process.

If our steps are insufficient to successfully remediate the material weaknesses and otherwise establish and maintain an effective system of internal control over financial reporting, the reliability of our financial reporting, investor confidence in us and the value of our common stock could be materially and adversely affected. The process of designing and implementing internal control over financial reporting required to comply with Section 404 will be time consuming, costly and complicated. Our independent registered public accounting firm was not engaged to audit the effectiveness of our internal control over financial reporting. We may discover other control deficiencies in the future, and we cannot assure you that we will not have a material weakness in future periods.

Effective internal control over financial reporting is necessary for us to provide reliable and timely financial reports and, together with adequate disclosure controls and procedures, are designed to reasonably detect and prevent fraud. Any failure to implement required new or improved controls, or difficulties encountered in their implementation could cause us to fail to meet our reporting obligations. For as long as we are an “emerging growth company” under the Jumpstart Our Business Startups Act of 2012, or the JOBS Act, our independent registered public accounting firm will not be required to attest to the effectiveness of our internal control over financial reporting pursuant to Section 404. We could be an “emerging growth company” for up to five years. An independent assessment of the effectiveness of our internal control over financial reporting could detect problems that our management’s assessment might not. Undetected material weaknesses in our internal control over financial reporting could lead to financial statement restatements and require us to incur the expense of remediation.

***Fluctuations in foreign currency exchange rates could result in declines in our reported revenue and operating results.***

As a result of our international activities, we have revenue, expenses, cash, accounts receivable and payment obligations denominated in foreign currencies including Euros, British Pounds Sterling, Indian Rupees, Japanese Yen, and Chinese Yuan. Foreign currency risk arises primarily from the net difference between non-United States dollar receipts from customers and non-United States dollar operating expenses. The value of foreign currencies against the United States dollar can fluctuate significantly, and those fluctuations may occur quickly. We cannot predict the impact of future foreign currency fluctuations.

Further strengthening of the United States dollar could cause our software to become relatively more expensive to some of our customers leading to decreased sales and a reduction in billings and revenue not denominated in United States dollars. A reduction in revenue or an increase in operating expenses due to fluctuations in foreign currency exchange rates could have an adverse effect on our financial condition and operating results. Such foreign currency exchange rate fluctuations may make it more difficult to detect underlying trends in our business and operating results.

We do not currently, and do not have plans to, engage in currency hedging activities to limit the risk of exchange rate fluctuations. In the future, we may use derivative instruments, such as foreign currency forward and option contracts, to hedge certain exposures to fluctuations in foreign currency exchange rates. The use of such hedging activities may not offset any or more than a portion of the adverse financial effects of unfavorable movements in foreign exchange rates over the limited time the hedges are in place, and the cost of those hedging techniques may have a significant negative impact on our operating results. The use of hedging instruments may introduce additional risks if we are unable to structure effective hedges with such instruments. If we are not able to successfully manage or hedge against the risks associated with currency fluctuations, our financial condition and operating results could be adversely affected.



***If we fail to attract new or retain existing third party independent software vendors to participate in the APA, we may not be able to grow the APA program.***

The APA program allows our customers to use third party software that may be unrelated to our software, without the need to enter into additional license agreements. The APA program results in increased revenues through revenue sharing, and encourages users to stay within the Altair software ecosystem. If third party software providers are unwilling to join the APA on appropriate terms, including agreeing with our revenue share allocations, or if we are unable to retain our current APA participants, we may not be able to grow the APA program.

***Licensing of our solidThinking software is dependent on performance of our distributors and resellers.***

We have historically licensed our software primarily through our direct sales force. Our solidThinking offerings are primarily licensed through a recently expanded network of distributors and resellers. If these distributors and resellers become unstable, financially insolvent, or otherwise do not perform as we expect, our revenue growth derived from solidThinking could be negatively impacted.

***If we fail to adapt to technology changes our software may become less marketable, less competitive, or obsolete.***

Our success depends in part on our ability to:

- anticipate customer needs;
- foresee changes in technology, including to cloud-enabled hardware, software, networking, browser and database technologies;
- differentiate our software;
- maintain operability of our software with changing technology standards; and
- develop or acquire additional or complementary technologies.

We may not be able to develop or market new or enhanced software in a timely manner, which could result in our software becoming less marketable, less competitive, or obsolete.

***We believe our long-term value as a company will be greater if we focus on growth, which may negatively impact our profitability in the near term.***

Part of our business strategy is to focus on our long-term growth. As a result, our profitability may be lower in the near term than it would be if our strategy was to maximize short-term profitability. Expanding our research and development efforts, sales and marketing efforts, infrastructure and other such investments may not ultimately grow our business or cause higher long-term profitability. If we are ultimately unable to achieve greater profitability at the level anticipated by analysts and our stockholders, our Class A common stock price may decline.

***Our research and development may not generate revenue or yield expected benefits.***

A key element of our strategy is to invest significantly in research and development to create new software and enhance our existing software to address additional applications and serve new markets. Research and development projects can be technically challenging and expensive, and there may be delays between the time we incur expenses and the time we are able to generate revenue, if any. Anticipated customer demand for any software we may develop could decrease after the development cycle has commenced, and we could be unable to avoid costs associated with the development of any such software. If we expend a significant amount of resources on research and development and our efforts do not lead to the timely introduction or improvement of software that is competitive in our current or future markets, it could harm our business.

***Our continued innovation may not generate revenue or yield expected benefits.***

As a business focused on innovation, we expect to continue developing new software and products both internally and through acquisitions. These offerings may focus either on our existing markets or other markets in which we see opportunities. We may not receive revenue from these investments sufficient to either grow our business or cover the related development or acquisition costs.

***If we lose our senior executives, we may be unable to achieve our business objectives.***

We currently depend on the continued services and performance of James Scapa, our chief executive officer, and other senior executives. Many members of this executive team have served the Company for more than 15 years, with Mr. Scapa having served since our founding in 1985. Loss of Mr. Scapa's services or those of other senior executives could delay or prevent the achievement of our business objectives.

***If we are unable to attract and retain key personnel, we may be unable to achieve our business objectives.***

Our business is dependent on our ability to attract and retain highly skilled software engineers, salespeople, and support teams. There is significant industry competition for these individuals. We have many employees whose equity awards in our company are fully vested and may increase their personal wealth after giving effect to our offering, which could affect their decision to remain with the Company. Failure to attract or retain key personnel could delay or prevent the achievement of our business objectives.

***Defects or errors in our software could result in loss of revenue or harm to our reputation.***

Our software is complex and, despite extensive testing and quality control, may contain undetected or perceived bugs, defects, errors, or failures. From time to time we have found defects or errors in our software and we may discover additional defects in the future. We may not find defects or errors in new or enhanced software before release and these defects or errors may not be discovered by us or our customers until after they have used the software. We have in the past issued, and may in the future need to issue, corrective releases or updates of our software to remedy bugs, defects and errors or failures. The occurrence of any real or perceived bugs, defects, errors, or failures could result in:

- lost or delayed market acceptance of our software;
- delays in payment to us by customers;
- injury to our reputation;
- diversion of our resources;
- loss of competitive position;
- claims by customers for losses sustained by them;
- breach of contract claims or related liabilities;
- increased customer support expenses or financial concessions; and
- increased insurance costs.

Any of these problems could have a material adverse effect on our business, financial position, results of operations and cash flows.

***Acquisitions may dilute our stockholders, disrupt our core business, divert our resources, or require significant management attention.***

Most of our software has been developed internally with acquisitions used to augment our capabilities. We may not effectively identify, evaluate, integrate, or use acquired technology or personnel from future acquisitions, or accurately forecast the financial impact of an acquisition, including accounting charges.

After the completion of an acquisition, it is possible that our valuation of such acquisition for purchase price allocation purposes may change compared to initial expectations and result in unanticipated write-offs or charges, impairment of our goodwill, or a material change to the fair value of the assets and liabilities associated with a particular acquisition.

We may pay cash, incur debt, or issue equity securities to fund an acquisition. The payment of cash will decrease available cash. The incurrence of debt would likely increase our fixed obligations and could subject us to restrictive covenants or obligations. The issuance of equity securities would likely be dilutive to our stockholders. We may also incur unanticipated liabilities as a result of acquiring companies. Future acquisition activity may disrupt our core business, divert our resources, or require significant management attention.

***Failure to protect and enforce our proprietary technology and intellectual property rights could substantially harm our business.***

The success of our business depends, in part, on our ability to protect and enforce our proprietary technology and intellectual property rights, including our trade secrets, patents, trademarks, copyrights, and other intellectual property. We attempt to protect our intellectual property under trade secret, patent, trademark, and copyright laws. Despite our efforts, we may not be able to protect our proprietary technology and intellectual property rights, if we are unable to enforce our rights or if we do not detect unauthorized use of our intellectual property. It may be possible for unauthorized third parties to copy our technology and use information that we regard as proprietary to create products and services that compete with ours. Provisions in our licenses protect against unauthorized use, copying, transfer and disclosure of our technology, but such provisions may be difficult to enforce or are unenforceable under the laws of certain jurisdictions and countries. The laws of some countries do not protect proprietary rights to the same extent as the laws of the United States. Our international activities expose us to unauthorized copying and use of our technology and proprietary information.

We primarily rely on our unpatented proprietary technology and trade secrets. Despite our efforts to protect our proprietary technology and trade secrets, unauthorized parties may attempt to misappropriate, reverse engineer or otherwise obtain and use them. The contractual provisions that we enter into with employees, consultants, partners, vendors and customers may not be sufficient to prevent unauthorized use or disclosure of our proprietary technology or trade secrets and may not provide an adequate remedy in the event of unauthorized use or disclosure of our proprietary technology or trade secrets.

Policing unauthorized use of our technologies, software and intellectual property is difficult, expensive and time-consuming, particularly in countries where the laws may not be as protective of intellectual property rights as those in the United States and where mechanisms for enforcement of intellectual property rights may be weak. We may be unable to detect or determine the extent of any unauthorized use or infringement of our software, technologies or intellectual property rights.

From time to time, we may need to engage in litigation or other administrative proceedings to protect our intellectual property rights or to defend against allegations by third parties that we have infringed or misappropriated their intellectual property rights, including in connection with requests for indemnification by our customers who may face such claims. We have been approached and may be approached in the future by

certain of our customers to indemnify them against third party intellectual property claims. Litigation and/or any requests for indemnification by our customers could result in substantial costs and diversion of resources and could negatively affect our business and revenue. If we are unable to protect and enforce our intellectual property rights, our business may be harmed.

***Intellectual property disputes could result in significant costs and harm our business.***

Intellectual property disputes may occur in the markets in which we compete. Many of our competitors are large companies with significant intellectual property portfolios, which they may use to assert claims of infringement, misappropriation or other violations of intellectual property rights against us, or our customers. Any allegation of infringement, misappropriation or other violation of intellectual property rights by a third party, even those without merit, could cause us to incur substantial costs defending against the claim, could distract our management from our business, and could cause uncertainty among our customers or prospective customers, all of which could have an adverse effect on our business or revenue. We are currently engaged in ongoing litigation with MSC, a competitor of ours, who brought suit against us in 2007 alleging misappropriation of trade secrets, breach of confidentiality and other employment-related claims. A jury returned a verdict against us in April 2014. After a successful challenge by us in November 2014, this verdict was partially vacated except for damages for \$425,000 related to certain employment matters and the court ordered a new trial on damages for the trade secrets claims. No trial date is scheduled. On August 21, 2017, the court granted Altair's motion to strike the testimony of MSC's damage expert. The court has not provided guidance on how the case will proceed. We cannot be certain of the outcome of this matter. We agreed to indemnify our employees named in the MSC litigation. See the section entitled "Business—Legal and regulatory—Legal proceedings—Litigation."

Our agreements may include provisions that require us to indemnify others for losses suffered or incurred as a result of our infringement of a third party's intellectual property rights infringement, including certain of our employees and customers.

An adverse outcome of a dispute or an indemnity claim may require us to:

- pay substantial damages;
- cease licensing our software or portions of it;
- develop non-infringing technologies;
- acquire or license non-infringing technologies; and
- make substantial indemnification payments.

Any of the foregoing or other damages could harm our business, decrease our revenue, increase our expenses or negatively impact our cash flow.

***Security breaches, computer malware, computer hacking attacks and other security incidents could harm our business, reputation, brand and operating results.***

Security incidents have become more prevalent across industries and may occur on our systems. Security incidents may be caused by, or result in but are not limited to, security breaches, computer malware or malicious software, computer hacking, unauthorized access to confidential information, denial of service attacks, security system control failures in our own systems or from vendors we use, email phishing, software vulnerabilities, social engineering, sabotage and drive-by downloads. Such security incidents, whether intentional or otherwise, may result from actions of hackers, criminals, nation states, vendors, employees or customers.

## [Table of Contents](#)

We may experience disruptions, data loss, outages and other performance problems on our systems due to service attacks, unauthorized access or other security related incidents. Any security breach or loss of system control caused by hacking, which involves efforts to gain unauthorized access to information or systems, or to cause intentional malfunctions or loss, modification or corruption of data, software, hardware or other computer equipment and the inadvertent transmission of computer malware could harm our business.

In addition, our software stores and transmits customers' confidential business information in our facilities and on our equipment, networks and corporate systems. Security incidents could expose us to litigation, remediation costs, increased costs for security measures, loss of revenue, damage to our reputation and potential liability. Our customer data and corporate systems and security measures may be compromised due to the actions of outside parties, employee error, malfeasance, capacity constraints, a combination of these or otherwise and, as a result, an unauthorized party may obtain access to our data or our customers' data. Outside parties may attempt to fraudulently induce our employees to disclose sensitive information in order to gain access to our customers' data or our information. We must continuously examine and modify our security controls and business policies to address new threats, the use of new devices and technologies, and these efforts may be costly or distracting.

Because the techniques used to obtain unauthorized access, disable or degrade service, or sabotage systems change frequently or may be designed to remain dormant until a predetermined event and often are not recognized until launched against a target, we may be unable to anticipate these techniques or implement sufficient control measures to defend against these techniques. Though it is difficult to determine what harm may directly result from any specific incident or breach, any failure to maintain confidentiality, availability, integrity, performance and reliability of our systems and infrastructure may harm our reputation and our ability to retain existing customers and attract new customers. If an actual or perceived security incident occurs, the market perception of the effectiveness of our security controls could be harmed, our brand and reputation could be damaged, we could lose customers, and we could suffer financial exposure due to such events or in connection with remediation efforts, investigation costs, regulatory fines and changed security control, system architecture and system protection measures.

### ***Adverse global conditions, including economic uncertainty, may negatively impact our financial results.***

Global conditions, including the effects of the outcome of the United Kingdom's referendum on membership in the European Union or any negative financial impacts affecting United States corporations operating on a global basis as a result of tax reform or changes to existing trade agreements or tax conventions, could adversely impact our business in a number of ways, including longer sales cycles, lower prices for our software license fees, reduced licensing renewals or foreign currency fluctuations.

During challenging economic times our customers may be unable or unwilling to make timely payments to us, which could cause us to incur increased bad debt expenses. Our customers may unilaterally extend the payment terms of our invoices, adversely affecting our short-term or long-term cash flows.

### ***International operations expose us to risks inherent in international activities.***

Operating in international markets requires significant resources and management attention and subjects us to regulatory, economic and political risks that are different from those in the United States. We face risks in doing business internationally that could adversely affect our business, including:

- the need to localize and adapt our software for specific countries, including translation into foreign languages and associated expenses;
- foreign exchange risk;

## [Table of Contents](#)

- import and export restrictions and changes in trade regulation, including uncertainty regarding renegotiation of international trade agreements and partnerships;
- sales and customer service challenges associated with operating in different countries;
- enhanced difficulties of integrating any foreign acquisitions;
- difficulties in staffing and managing foreign operations and working with foreign partners;
- different pricing environments, longer sales cycles, longer accounts receivable payment cycles, and collections issues;
- compliance challenges related to the complexity of multiple, conflicting and changing governmental laws and regulations, including the Foreign Corrupt Practices Act of 1977, or the FCPA, employment, ownership, tax, privacy and data protection laws and regulations;
- limitations on enforcement of intellectual property rights;
- more restrictive or otherwise unfavorable government regulations;
- increased financial accounting and reporting burdens and complexities;
- restrictions on the transfer of funds;
- withholding and other tax obligations on remittance and other payments made by our subsidiaries; and
- unstable regional, economic and political conditions.

Our inability to manage any of these risks successfully, or to comply with these laws and regulations, could reduce our sales and harm our business.

### ***We may lose customers if our software does not work seamlessly with our customers' existing software.***

Our customers may use our software, which in many instances has been designed to seamlessly interface with software from some of our competitors, together with their own software and software they license from third parties. If our software ceases to work seamlessly with our customers' existing software applications, we may lose customers.

### ***Our customers use our software and services to design and develop their products, which when built and used may expose us to claims.***

Many of our customers use our software and services, together with software and services from other third parties and their own resources, to assist in the design and development of products intended to be used in a commercial setting. To the extent our customers design or develop a product that results in potential liability, including product liability, we may be included in resulting litigation. We may be subject to litigation defense costs or be subject to potential judgments or settlement costs for which we may not be fully covered by insurance, which would result in an increase of our expenses.

We also license our software on Altair branded computer hardware, which we acquire from an original equipment manufacturer, which we refer to as an OEM, exposing us to potential liability for the hardware, such as product liability. To the extent this liability is greater than the warranty and liability protection from our OEM, we may incur additional expenses, which may be significant.

***If we fail to educate and train our users regarding the use and benefits of our software, we may not generate additional revenue.***

Our software is complex and highly technical. We continually educate and train our existing and potential users regarding the depth, breadth, and benefits of our software including through classroom and online training. If these users do not receive education and training regarding the use and benefits of our software, or the education and training is ineffective, they may not increase their usage of our software. We incur costs of training directly related to this activity prior to generating additional revenue, if any.

***If we are unable to match engineers to open positions in our CES business or are otherwise unable to grow our CES business, our revenue could be adversely affected.***

We operate our client engineering services business by hiring engineers for placement at a customer site for specific customer-directed assignments and pay them only for the duration of the placement. The success of this business is dependent upon our ability to recruit and retain highly skilled, qualified engineers to meet the requirements of our customers and to maintain ongoing relationships with these customers. Our CES business constituted approximately 15% of our total revenues for each of the years ended December 31, 2015 and 2016. Some of our customers operate their engineering personnel needs through managed service providers, or MSPs. A significant percentage of the engineers we place, either directly or through MSPs, are with U.S.-based customers and are citizens of countries other than the United States. In the event these engineers are unable to enter into the United States legally, we may be unable to match engineers with the appropriate skill sets matched to open customer positions. If we are unable to attract highly skilled, qualified engineers because of competitive factors or immigration laws, or otherwise fail to match engineers to open customer positions, our revenue may be adversely affected.

***Our sales to United States government agencies and their suppliers may be subject to reporting and compliance requirements.***

Our customers include agencies of the United States government and their suppliers of products and services. These customers may procure our software and services through United States government mandated procurement regulations. Because of United States government reporting and compliance requirements we may incur unexpected costs. United States government agencies and their suppliers may have statutory, contractual or other legal rights to terminate contracts for convenience or due to a default, and any such termination may adversely affect our future operating results.

***Our sales to non-United States government agencies and their suppliers may be subject to reporting and compliance requirements.***

Our customers include agencies of various non-United States governments and their suppliers of products and services. These customers procure our software and services through various governments' mandated procurement regulations. Because of governmental reporting and compliance requirements we may incur unexpected costs. Government agencies and their suppliers may have statutory, contractual or other legal rights to terminate contracts for convenience or due to a default, and any such termination may adversely affect our future operating results.

***We may require additional capital to support our business, which may not be available on acceptable terms.***

We expect to continue to make investments in our business, which may require additional funds. We may raise these funds through either equity or debt financings. Issuances of equity or convertible debt securities may significantly dilute stockholders and any new equity securities could have rights, preferences and privileges superior to those holders of our Class A common stock. Future debt financings could contain restrictive

## [Table of Contents](#)

covenants relating to our capital raising activities and other financial and operational matters, which may make it more difficult for us to obtain additional capital, manage our business and pursue business opportunities, including potential acquisitions.

We may not be able to obtain additional financing on terms favorable to us. If we are unable to obtain adequate financing or financing on terms satisfactory to us when we require it, our ability to continue to support our growth, develop new software or add capabilities and enhancements to our existing software and respond to business challenges could be significantly impaired, and our business may be adversely affected.

### ***Our loan agreements contain operating and financial covenants that may restrict our business and financing activities.***

Our Credit Agreement is unconditionally guaranteed by us and all existing and subsequently acquired controlled domestic subsidiaries. It is also collateralized by a first priority, perfected security interest in, and mortgages on, substantially all of our tangible assets. The Credit Agreement contains operating financial restrictions and covenants, including liens, limitations on indebtedness, fundamental changes, limitations on guarantees, limitations on sales of assets and sales of receivables, dividends, distributions and other restricted payments, transactions with affiliates, prepayment of indebtedness and limitations on loans and investments in each case subject to certain exceptions. The Credit Agreement also requires us to maintain a minimum level of liquidity, which shall not be less than \$20,000,000 at the end of each fiscal quarter. We intend to enter into a new revolving credit facility in connection with the closing of this offering on similar terms as described above and subject to similar operating financial restrictions and covenants. We expect to repay borrowings under our Credit Agreement and pay the origination fees and expenses related to entering into the new revolving credit facility with the proceeds of this offering. The restrictions and covenants in the Credit Agreement, as well as those contained in any future debt financing agreements that we may enter into, including our New Credit Facility, may restrict our ability to finance our operations and engage in, expand or otherwise pursue our business activities and strategies. Our ability to comply with these covenants and restrictions may be affected by events beyond our control, and breaches of these covenants and restrictions could result in a default under the loan agreement and any future financing agreements that we may enter into. See the section entitled “Management’s discussion and analysis of financial condition and results of operations—Liquidity and capital resources” for further information about our Credit Agreement and our new revolving credit facility and Note 7 to our consolidated financial statements included elsewhere in this prospectus for further information about our credit facility.

### ***We operate internationally and must comply with employment and related laws in various countries, which may, in turn, result in unexpected expenses.***

We are subject to a variety of domestic and foreign employment laws, including those related to safety, discrimination, whistle-blowing, employment of illegal aliens, classification of employees, wages, statutory benefits, and severance payments. Such laws are subject to change as a result of judicial decisions or otherwise, and there can be no assurance that we will not be found to have violated any such laws in the future. Such violations could lead to the assessment of significant fines against us by federal, state or foreign regulatory authorities or to the award of damages claims, including severance payments, against us in judicial or administrative proceedings by employees or former employees, any of which would reduce our net income or increase our net loss.

### ***Changes in government trade, immigration or currency policies may harm our business.***

We operate our business globally in multiple countries that have policies and regulations relating to trade, immigration and currency, which may change. Governments may change their trade policies by withdrawing



## [Table of Contents](#)

from negotiations on new trade policies, renegotiating existing trade agreements, imposing tariffs or imposing other trade restrictions or barriers. Any such changes may result in:

- changes in currency exchange rates;
- changes in political or economic conditions;
- import or export licensing requirements or other restrictions on technology imports and exports;
- laws and business practices favoring local companies;
- changes in diplomatic and trade relationships;
- modification of existing or implementation of new tariffs;
- imposition or increase of trade barriers; or
- establishment of new trade or currency restrictions.

Any of these changes, changes in immigration policies, government intervention in currency valuation or other government policy changes may adversely impact our ability to sell software and services, which could, in turn, harm our revenues and our business. We are headquartered in the United States and may be particularly impacted by changes affecting the United States.

### ***Our use of open source technology could impose limitations on our ability to commercialize our software.***

We use open source software in some of our software and expect to continue to use open source software in the future. Although we monitor our use of open source software to avoid subjecting our software to conditions we do not intend, we may face allegations from others alleging ownership of, or seeking to enforce the terms of, an open source license, including by demanding release of the open source software, derivative works, or our proprietary source code that was developed using such software. These allegations could also result in litigation. The terms of many open source licenses have not been interpreted by United States courts. There is a risk that these licenses could be construed in a way that could impose unanticipated conditions or restrictions on our ability to commercialize our software. In such an event, we may be required to seek licenses from third parties to continue commercially offering our software, to make our proprietary code generally available in source code form, to re-engineer our software or to discontinue the sale of our software if re-engineering could not be accomplished on a timely basis, any of which could adversely affect our business and revenue.

The use of open source software subjects us to a number of other risks and challenges. Open source software is subject to further development or modification by anyone. Others may develop such software to be competitive with or no longer useful by us. It is also possible for competitors to develop their own solutions using open source software, potentially reducing the demand for our software. If we are unable to successfully address these challenges, our business and operating results may be adversely affected and our development costs may increase.

### ***We currently open source certain of our software and may open source other software in the future, which could have an adverse effect on our revenues and expenses.***

We offer a portion of our Altair PBS workload management software in an open source version to generate additional usage and broaden user-community development and enhancement of the software. We offer related software and services on a paid basis. We believe increased usage of open source software leads to increased purchases of these related paid offerings. We may offer additional software on an open source basis in the future. There is no assurance that the incremental revenues from related paid offerings will outweigh the lost revenues and incurred expenses attributable to the open sourced software.

***Our revenue mix may vary over time, which could harm our gross margin and operating results.***

Our revenue mix may vary over time due to a number of factors, including the mix of term-based licenses and perpetual licenses. Due to the differing revenue recognition policies applicable to our term-based licenses, perpetual licenses and professional services, shifts in the mix between subscription and perpetual licenses from quarter to quarter, or increases or decreases in revenue derived from our professional engineering services, which have lower gross margins than our software services, could produce substantial variation in revenues recognized even if our billings remain consistent. Our gross margins and operating results could be harmed by changes in revenue mix and costs, together with other factors, including: entry into new markets or growth in lower margin markets; entry into markets with different pricing and cost structures; pricing discounts; and increased price competition. Any one of these factors or the cumulative effects of certain of these factors may result in significant fluctuations in our gross margin and operating results. This variability and unpredictability could result in our failure to meet internal expectations or those of securities analysts or investors for a particular period. If we fail to meet or exceed such expectations for these or any other reasons, the market price of our common stock could decline.

***The estimates of market opportunity and forecasts of market growth included in this prospectus may prove to be inaccurate, and even if the market in which we compete achieves the forecasted growth, our business could fail to grow at similar rates, if at all.***

Market opportunity estimates and growth forecasts included in this prospectus, including those we have generated ourselves, are subject to significant uncertainty and are based on assumptions and estimates that may not prove to be accurate. Even if the market in which we compete meets the size estimates and growth forecasted in this prospectus, our business could fail to grow for a variety of reasons, which would adversely affect our results of operations. For more information regarding the estimates of market opportunity and the forecasts of market growth included in this prospectus, see the section entitled “Business—Market opportunity.”

***We are subject to governmental export and import controls that could impair our ability to compete in international markets due to licensing requirements and subject us to liability if we are not in compliance with applicable laws.***

Our software, services and hardware are subject to export control and import laws and regulations. As a company headquartered in the United States we are subject to regulations, including the International Traffic in Arms Regulations, or ITAR, and Export Administration Regulations, or EAR, United States Customs regulations and various economic and trade sanctions regulations administered by the United States Treasury Department’s Office of Foreign Assets Controls presenting further risk of unexpected reporting and compliance costs. Compliance with these regulations may also prevent and restrict us from deriving revenue from potential customers in certain geographic locations for certain of our technologies.

If we fail to comply with these laws and regulations, we and certain of our employees could be subject to substantial civil or criminal penalties, including the possible loss of export or import privileges, fines which may be imposed on us and responsible employees or managers and, in extreme cases, the incarceration of responsible employees or managers. Obtaining the necessary authorizations, including any required license, for a particular sale may be time-consuming, is not guaranteed and may result in the delay or loss of sales opportunities. In addition, changes in our software or changes in applicable export or import regulations may create delays in the introduction and sale of our software in international markets, prevent our customers with international operations from deploying our software or, in some cases, prevent the export or import of our software to certain countries, governments or persons altogether. Any change in export or import regulations, shift in the enforcement or scope of existing regulations, or change in the countries, governments, persons or technologies targeted by such regulations, could also result in decreased use of our software, or in our decreased ability to export or license our software to existing or potential customers with international

## [Table of Contents](#)

operations. Any decreased use of our software or limitation on our ability to export or license our software will likely adversely affect our business.

We incorporate encryption technology into portions of our software. Various countries regulate the import of certain encryption technology, including through import permitting and licensing requirements, and have enacted laws that could limit our ability to distribute our software or could limit our customers' ability to implement our software in those countries. Encrypted software and the underlying technology may also be subject to export control restrictions. Governmental regulation of encryption technology and regulation of imports or exports of encryption products, or our failure to obtain required import or export approval for our software, when applicable, could harm our international sales and adversely affect our revenue. Compliance with applicable regulatory requirements regarding the export of our software, including with respect to new releases of our software, may create delays in the introduction of our software in international markets, prevent our customers with international operations from deploying our software throughout their globally-distributed systems or, in some cases, prevent the export of our software to some countries altogether.

United States export control laws and economic sanction programs prohibit the shipment of certain software and services to countries, governments and persons that are subject to United States economic embargoes and trade sanctions. Any violations of such economic embargoes and trade sanction regulations could have negative consequences, including government investigations, penalties and reputational harm.

Any change in export or import regulations, economic sanctions or related legislation, shift in the enforcement or scope of existing regulations, or change in the countries, governments, persons or technologies targeted by such regulations, could result in decreased use of our software by, or in our decreased ability to export or license our software to, existing or potential customers with international operations. Any decreased use of our software or limitation on our ability to export or license our software could adversely affect our business.

***Our business is subject to a wide range of laws and regulations, and our failure to comply with those laws and regulations could harm our business.***

Our business is subject to regulation by various federal, state, local and foreign governmental agencies, including agencies responsible for monitoring and enforcing employment and labor laws, workplace safety, environmental laws, privacy and data protection laws, anti-bribery laws, import and export controls, federal securities laws and tax laws and regulations. In certain foreign jurisdictions, these regulatory requirements may be more stringent than those in the United States. These laws and regulations are subject to change over time and thus we must continue to monitor and dedicate resources to ensure continued compliance. Non-compliance with applicable regulations or requirements could subject us to investigations, sanctions, mandatory product recalls, enforcement actions, disgorgement of profits, fines, damages, civil and criminal penalties or injunctions. If any governmental sanctions are imposed, or if we do not prevail in any possible civil or criminal litigation, our business, operating results, and financial condition could be materially adversely affected. In addition, responding to any action will likely result in a significant diversion of management's attention and resources and an increase in professional fees. Enforcement actions and sanctions could harm our business, operating results and financial condition.

***If we or any of our employees violate the United States Foreign Corrupt Practices Act, the U.K. Bribery Act or similar anti-bribery laws we could be adversely affected.***

The United States Foreign Corrupt Practices Act, or FCPA, the U.K. Bribery Act and similar anti-bribery laws generally prohibit companies and their intermediaries from authorizing, offering or providing, directly or indirectly, improper payments or benefits for the purpose of obtaining or retaining business to government officials, political parties and private-sector recipients. United States based companies are required to maintain records that accurately and fairly represent their transactions and have an adequate system of internal

accounting controls. We operate in areas of the world that potentially experience corruption by government officials to some degree and, in certain circumstances, compliance with anti-bribery laws may conflict with local customs and practices. We cannot assure that our employees, resellers or distributors will not engage in prohibited conduct. If we are found to be in violation of the FCPA, the U.K. Bribery Act or other anti-bribery laws we could suffer criminal or civil penalties or other sanctions.

***Business interruptions could adversely affect our business.***

Our operations and our customers are vulnerable to interruptions by fire, flood, earthquake, power loss, telecommunications failure, terrorist attacks, wars and other events beyond our control. A catastrophic event that results in the destruction of any of our critical business or information technology systems could severely affect our ability to conduct normal business operations, including system interruptions, reputational harm, delays in our software development, breaches of data security and loss of critical data.

We rely on our network and third party infrastructure and applications, internal technology systems, and our websites for our development, marketing, operational support, hosted services and sales activities. If these systems were to fail or be negatively impacted as a result of a natural disaster or other event, our ability to deliver software and training to our customers could be impaired.

Our business interruption insurance may not be sufficient to compensate us fully for losses or damages that may occur as a result of these events, if at all.

***Our reported financial results may be adversely affected by changes in accounting principles generally accepted in the United States.***

GAAP are subject to interpretation by the Financial Accounting Standards Board, or FASB, the United States Securities and Exchange Commission, or the SEC, and various bodies formed to promulgate and interpret appropriate accounting principles. A change in these principles or interpretations could have a significant effect on our reported financial results for periods prior and subsequent to such change. We will need to comply with the FASB issued Accounting Standards Update No. 2014-09, Revenue from Contracts with Customers. This standard outlines a single comprehensive model for entities to use in accounting for revenue arising from contracts with customers and supersedes most existing revenue recognition guidance under GAAP. The core principle of the guidance is that an entity should recognize revenue when it transfers promised goods or services to customers in an amount that reflects the consideration to which the company expects to be entitled in exchange for those goods and services. We expect the timing of revenue recognition to be accelerated because we anticipate that license revenue will be recognized at a point in time, rather than over time, which is our current practice. Generally, the license revenue component of an arrangement represents a significant portion of the overall fair value of a software arrangement. While we continue to assess the potential impacts, under the new standards there is the potential for significant impacts on the consolidated financial statements.

The application of this new guidance may result in a change in the timing and pattern of revenue recognition including the retrospective recognition of revenue in historical periods that may negatively affect our future revenue trend, which, despite no change in associated cash flows, could have a material adverse effect on our net income (loss). The adoption of new standards may potentially require enhancements or changes in our systems and will require significant time and cost on behalf of our financial management.

As an "emerging growth company" the JOBS Act allows us an extended transition period for complying with new and revised accounting standards that have different effective dates for public and private companies until the earlier of the date (i) we are no longer an emerging growth company, or (ii) affirmatively and irrevocably opt out of the extended transition period provided in the JOBS Act. We have elected to use this extended transition period under the JOBS Act, including with respect to ASU 2014-09. As a result, we will not be required to apply ASU 2014-09 until January 1, 2019.

## [Table of Contents](#)

We cannot predict the impact of all of the future changes to accounting principles or our accounting policies on our consolidated financial statements going forward, which could have a significant effect on our reported financial results, and could affect the reporting of transactions completed before the announcement of the change. In addition, if we were to change our critical accounting estimates, including those related to the recognition of license revenue and other revenue sources, our operating results could be significantly affected.

***If our goodwill or intangible assets become impaired, we may be required to record a significant charge to earnings, which could harm our business.***

Under GAAP, we review our intangible assets for impairment when events or changes in circumstances indicate the carrying value may not be recoverable. Goodwill is required to be tested for impairment at least annually. As of June 30, 2017, and December 31, 2016 respectively, we have \$43.7 million and \$36.6 million of goodwill and \$16.0 million and \$11.2 million of other intangible assets—net. An adverse change in market conditions, particularly if such change has the effect of changing one of our critical assumptions or estimates, could result in a change to the estimation of fair value that could result in an impairment charge.

***We have significant deferred tax assets in the United States, which we may not use in future taxable periods.***

As of June 30, 2017, and December 31, 2016 we had net deferred tax assets, or DTAs, of \$65.8 million and \$61.5 million, respectively, primarily related to tax credits, share-based compensation, deferred revenue, and capitalized research and development expenses. We are entitled to a United States federal tax deduction when non-qualified stock options, or NSOs, are exercised. In connection with this offering, we expect a significant number of our NSOs will be exercised, creating substantial additional tax deductions for us. These deductions are expected to result in future net operating losses for United States tax purposes which are expected to result in our needing to establish a valuation allowance for the majority of our DTAs. Our ability to utilize any net operating losses or tax credits could be limited under provisions of the Internal Revenue Code of 1986, or the Code, if we undergo an ownership change in connection with or after this offering, provided, that for this purpose an ownership change is generally defined as a greater than 50-percentage-point cumulative change, by value, in the equity ownership of certain stockholders over a rolling three-year period. We do not expect to experience an ownership change in connection with our initial public offering. We may also be unable to realize our tax credit carryforwards as they begin to expire in 2018.

***If our global tax methodology is challenged our tax expense may increase.***

As a global business headquartered in the United States, we are required to pay tax in a number of different countries, exposing us to transfer pricing and other adjustments. Transfer pricing refers to the methodology of allocating revenue and expenses for tax purposes to particular countries. Taxing authorities may challenge our transfer pricing methodology, which if successful could increase our professional expenses and result in one-time tax charges, a higher worldwide effective tax rate, reduced cash flows, and lower overall profitability of our operations.

Our tax expense could be impacted depending on the applicability of withholding and other taxes including taxes on software licenses and related intercompany transactions under the tax laws of jurisdictions in which we have business operations. Our future income taxes may fluctuate if our earnings are either lower in countries that have low statutory tax rates or higher in countries that have high statutory tax rates. We are subject to review and audit by the United States and other taxing authorities. Any review or audit could increase our professional expenses and, if determined adversely, could result in unexpected costs.

Sales and use, value-added and similar tax laws and rates vary by jurisdiction. Any of these jurisdictions may assert that such taxes are applicable, which could result in tax assessments, penalties and interest.

***In addition to our software, we manufacture, distribute and sell products, which may expose us to product liability claims, product recalls, and warranty claims that could be expensive and harm our business.***

We manufacture, distribute and sell products through two wholly owned subsidiaries, Altair Product Design, Inc., which we refer to as APD, and Illumisys, Inc. doing business as toggled and which we refer to in this prospectus as toggled. Generally, APD supports our customers with engineering and design services, which may include the fabrication of equipment and prototypes that are sold to businesses but not sold to consumers. From time to time, certain customers may contract directly with us for services similar to those provided by APD. toggled designs, sources through contract manufacturers, and assembles in our own facilities LED lighting and related products for sale to consumers and businesses.

To the extent these products do not perform as expected, cause injury or death or are otherwise unsuitable for usage, we may be held liable for claims, including product liability and other claims. A product liability claim, any product recalls or an excessive warranty claim, whether arising from defects in design or manufacture or otherwise could negatively affect our APD or toggled sales or require a change in the design or manufacturing process of these products, any of which may harm our reputation and business.

***Failure to protect and enforce toggled's proprietary technology and intellectual property rights could substantially harm toggled's lighting business.***

Part of the success of toggled's lighting business depends on our ability to protect and enforce toggled's proprietary rights, including its patents, trademarks, copyrights, trade secrets and other intellectual property rights. As of December 31, 2016, toggled had 109 issued patents in the United States and more than 20 pending patent applications. We attempt to protect toggled's intellectual property under patent, trademark, copyright, and trade secret laws. However, the steps we take to protect its intellectual property may be inadequate. We will not be able to protect toggled's intellectual property if we are unable to enforce its rights or if we do not detect unauthorized use of its intellectual property. It may be possible for unauthorized third parties to copy toggled's technology and use information that it regards as proprietary to create products that compete with toggled's products. Some license provisions protecting against unauthorized use, copying, transfer and disclosure of toggled's technology may be unenforceable under the laws of certain jurisdictions and foreign countries. Further, the laws of some countries do not protect proprietary rights to the same extent as the laws of the United States.

The process of obtaining patent protection is uncertain, expensive and time-consuming, and we may not be able to prosecute all necessary or desirable patent applications at a reasonable cost or in a timely manner. In addition, issuance of a patent does not guarantee that we have an absolute right to practice our patented technology, or that we have the right to exclude others from practicing our patented technology. As a result, we may not be able to obtain adequate patent protection or to enforce our issued patents effectively.

From time to time, toggled enforces its patents and other intellectual property rights including through initiating litigation. Any such litigation could result in substantial costs and diversion of resources and could negatively affect toggled's business, operating results, financial condition and cash flows. If toggled is unable to protect toggled's intellectual property rights, its business, operating results and financial condition will be harmed.

***Assertions by third parties of infringement or other violations by toggled of their intellectual property rights, or other lawsuits brought against toggled, could result in significant costs and substantially harm toggled's business.***

Patent and other intellectual property disputes are common in the markets in which toggled competes. Some of toggled's competitors, own large numbers of patents, copyrights, trademarks and trade secrets, which they may use to assert claims of infringement, misappropriation or other violations of intellectual property rights

against toggled or its customers. As the number of patents and competitors in this market increases, allegations of infringement, misappropriation and other violations of intellectual property rights may increase. Any allegation of infringement, misappropriation or other violation of intellectual property rights by a third party, even those without merit, could cause toggled to incur substantial costs and resources defending against the claim, which could have an adverse effect on toggled's business.

***Some of our businesses may collect personal information and are subject to privacy laws.***

Companies that collect personal information are required to comply with the privacy laws adopted by United States and various state and foreign governments, including member states of the European Union. These privacy laws regulate the collection, use, storage, disclosure and security of data, such as names, email addresses and, in some jurisdictions, Internet Protocol addresses, that may be used to identify or locate an individual, including a customer or an employee.

Our Company includes the WEYV business, a consumer music and content service, which in the course of providing its service directly to consumers, collects and stores consumer information. Currently we expect to operate WEYV only within the United States and are only subject to the United States privacy laws. To the extent we expand our WEYV offering beyond the United States we will need to comply with the privacy laws of every country in which we operate. Some of our other products may collect personal data and would also be subject to these privacy laws.

These laws and regulations may require us to implement privacy and security policies, permit end-customers to access, correct and delete personal information stored or maintained by us, inform individuals of security breaches that affect their personal information, and, in some cases, obtain individuals' consent to use personally identifiable information for certain purposes. Governments could require that any personally identifiable information collected in a country not be disseminated outside of that country. We also may find it necessary or desirable to join industry or other self-regulatory bodies or other information security, or data protection, related organizations that require compliance with their rules pertaining to information security and data protection. We may agree to be bound by additional contractual obligations relating to our collection, use and disclosure of personal, financial and other data. Our failure to comply with these privacy laws or any actual or suspected security incident may result in governmental actions, fines and non-monetary penalties, which may harm our business.

The privacy laws in the member states of the European Union are in a state of flux and may evolve or change in the near to mid-term. To the extent any European Union member state or other country in which we operate, modifies or changes its interpretation of an existing privacy law or enacts any new privacy law, we may incur unexpected costs.

**Risks related to this offering and ownership of our Class A common stock**

***An active public trading market for our Class A common stock may not develop or be sustained.***

Prior to this offering, there has been no public market or active private market for trading shares of our Class A common stock. We expect to list our Class A common stock on the Nasdaq Global Select Market, in connection with this offering, however, an active trading market may not develop following the completion of this offering or, if developed, may not be sustained. The lack of an active market may impair your ability to sell your shares at the time you wish to sell them or at a price that you consider reasonable. The lack of an active market may also reduce the price of shares of Class A common stock. An inactive market may impair our ability to raise capital by selling shares and our ability to use our capital stock to acquire other companies or technologies. We cannot predict the prices at which our Class A common stock will trade. The initial public offering price of our Class A common stock may not bear any relationship to the market price at which our Class A common stock will trade after this offering.

***The market price of our Class A common stock may be volatile, and you could lose all or part of your investment.***

The market price of our Class A common stock following this offering will depend on a number of factors, many of which are beyond our control and may not be related to our operating performance. These fluctuations could cause you to lose all or part of your investment in our Class A common stock, since you might not be able to sell your shares at or above the price you paid in this offering. Factors that could cause fluctuations in the market price of our Class A common stock include the following:

- price and volume fluctuations in the overall stock market from time to time, including as a result of trends in the economy as a whole;
- volatility in the market prices and trading volumes of technology stocks;
- changes in operating performance and stock market valuations of other technology companies generally, or those in our industry in particular;
- the expiration of market stand-off or contractual lock-up agreements and sales of shares of our Class A common stock by us or our stockholders;
- the volume of shares of our Class A common stock available for public sale;
- failure of financial analysts to maintain coverage of us, changes in financial estimates by any analysts who follow our company, or our failure to meet these estimates or the expectations of investors;
- the financial projections we may provide to the public, any changes in these projections or our failure to meet these projections;
- announcements by us or our competitors of new software or new or terminated significant contracts, commercial relationships or capital commitments;
- public analyst or investor reaction to our press releases, other public announcements and filings with the SEC;
- rumors and market speculation involving us or other companies in our industry;
- actual or anticipated changes or fluctuations in our operating results;
- actual or anticipated developments in our business, our customers' businesses, or our competitors' businesses or the competitive landscape generally;
- litigation involving us, our industry or both, or investigations by regulators into our operations or those of our competitors;
- developments or disputes concerning our intellectual property or our solutions, or third party proprietary rights;
- announced or completed acquisitions of businesses or technologies by us or our competitors;
- new laws or regulations or new interpretations of existing laws or regulations applicable to our business;
- changes in accounting standards, policies, guidelines, interpretations or principles;
- any major changes in our management or our board of directors;
- general economic conditions and slow or negative growth of our markets; and



## [Table of Contents](#)

- other events or factors, including those resulting from war, incidents of terrorism or responses to these events.

In addition, the stock market in general, and the market for technology companies in particular, have experienced extreme price and volume fluctuations that have often been unrelated or disproportionate to the operating performance of those companies. Broad market and industry factors may affect the market price of our Class A common stock, regardless of our actual operating performance. In the past, following periods of volatility in the overall market and the market prices of a particular company's securities, securities class action litigation has often been instituted against that company. We may become the target of this type of litigation in the future. Securities litigation, if instituted against us, could result in substantial costs and divert our management's attention and resources from our business.

### ***We cannot predict the impact our capital structure may have on our stock price.***

In July 2017, S&P Dow Jones, a provider of widely followed stock indices, announced that companies with multiple share classes, such as ours, will not be eligible for inclusion in certain of their indices. As a result, our Class A common stock will likely not be eligible for these stock indices. Additionally, FTSE Russell, another provider of widely followed stock indices, recently stated that it plans to require new constituents of its indices to have at least five percent of their voting rights in the hands of public stockholders. Many investment funds are precluded from investing in companies that are not included in such indices, and these funds would be unable to purchase our Class A common stock. We cannot assure you that other stock indices will not take a similar approach to S&P Dow Jones or FTSE Russell in the future. Exclusion from indices could make our Class A common stock less attractive to investors and, as a result, the market price of our Class A common stock could be adversely affected.

### ***Sales of substantial amounts of our Class A common stock may dilute your voting power and your ownership interest in us.***

Sales of a substantial number of shares of our Class A common stock after this offering, particularly sales by our directors, executive officers and significant stockholders could adversely affect the market price of our Class A common stock and may make it more difficult to sell Class A common stock at a time and price that you deem appropriate. Based on the total number of outstanding shares of our common stock as of June 30, 2017, upon completion of this offering, we will have an aggregate of \_\_\_\_\_ shares of Class A common stock and \_\_\_\_\_ shares of Class B common stock outstanding, assuming no exercise of our outstanding stock options after June 30, 2017 and assuming the underwriters do not exercise their option to purchase additional shares.

All of the shares of Class A common stock sold in this offering will be freely tradable without restrictions or further registration under the Securities Act of 1933, as amended, or the Securities Act, except for any shares held by our affiliates as defined in Rule 144 under the Securities Act.

A substantial majority our outstanding shares of common stock are currently restricted from resale as a result of market standoff and "lock-up" agreements, as more fully described in "Shares Eligible for Future Sale." These shares will become available to be sold 181 days after the date of this prospectus. Shares held by directors, executive officers and other affiliates will be subject to volume limitations under Rule 144 under the Securities Act and various vesting agreements. In addition, the underwriters may, in their sole discretion, release all or some portion of the shares subject to market standoff or lock-up agreements prior to the expiration of the lock-up period. See the section entitled "Shares eligible for future sale" for more information. Sales of a substantial number of such shares upon expiration of the market standoff and lock-up agreements, or the perception that such sales may occur, or early release of these agreements, could cause our market price to fall or make it more difficult for you to sell your Class A common stock at a time and price that you deem appropriate.

## [Table of Contents](#)

We intend to register the offer and sale of an aggregate of approximately \_\_\_\_\_ shares of Class A common stock that have been issued or reserved for future issuance under our equity compensation plans on a Form S-8 registration statement. Once we register the offer and sale of these shares, they can be freely sold in the public market upon issuance, subject to the market standoff or lock-up agreements or unless they are held by “affiliates,” as that term is defined in Rule 144 of the Securities Act. If the holders of these shares choose to sell a large number of shares, they could adversely affect the market price for our Class A common stock.

We may also issue shares of our Class A common stock or securities convertible into shares of our Class A common stock from time to time in connection with a financing, acquisition, investment or otherwise. Any such issuance could result in substantial dilution to our existing stockholders and cause the trading price of our Class A common stock to decline.

***Our initial public offering price is substantially higher than the pro forma as adjusted net tangible book value per share of our outstanding Class A common stock, and new investors will experience immediate and substantial dilution.***

Our initial public offering price is substantially higher than the pro forma as adjusted net tangible book value per share of our Class A common stock based on the expected total value of our total assets, less our goodwill and other intangible assets, less our total liabilities immediately following this offering. If you purchase shares of our Class A common stock in this offering, you will experience immediate and substantial dilution of \$ \_\_\_\_\_ per share in the price you pay for our Class A common stock as compared to the pro forma as adjusted net tangible book value as of June 30, 2017, after giving effect to the issuance of shares of our Class A common stock in this offering at the initial public offering price of \$ \_\_\_\_\_ per share. Furthermore, if the underwriters exercise their option to purchase additional shares, if outstanding options are exercised, if we issue awards to our employees under our equity incentive plans, or if we otherwise issue additional shares of our Class A common stock, you could experience further dilution. For a further description of the dilution that you will experience immediately after this offering, see the section entitled “Dilution.”

***If financial or industry analysts do not publish research or reports about our business or if they issue inaccurate or unfavorable commentary or downgrade our Class A common stock, our stock price and trading volume could decline.***

The trading market for our Class A common stock will be influenced by the research and reports that industry or financial analysts publish about us or our business. We do not control these analysts or the content and opinions included in their reports. As a new public company, we may be slow to attract research coverage, and the analysts who publish information about our Class A common stock will have had relatively little experience with our company, which could affect their ability to accurately forecast our results and make it more likely that we fail to meet their estimates. In the event we obtain industry or financial analyst coverage, if any of the analysts who cover us issue an inaccurate or unfavorable opinion regarding our stock price, our stock price would likely decline. In addition, the stock prices of many companies in the technology industry have declined significantly after those companies have failed to meet, or often times exceeded, the financial guidance publicly announced by the companies or the expectations of analysts. If our financial results fail to meet, or significantly exceed, our announced guidance or the expectations of analysts or public investors, analysts could downgrade our Class A common stock or publish unfavorable research about us. If one or more of these analysts cease coverage of our company or fail to publish reports on us regularly, we could lose visibility in the financial markets, which in turn could cause our stock price or trading volume to decline.

***The dual class structure of our common stock has the effect of concentrating voting control with certain stockholders who hold shares of our Class B common stock, including our founders, certain of our directors and executive officers and affiliates, who will hold in the aggregate \_\_\_\_\_ % of the voting power of our capital stock***

**following the completion of this offering. This will limit or preclude your ability to influence corporate matters, including the election of directors, amendments of our organizational documents, and any merger, consolidation, sale of all or substantially all of our assets, or other major corporate transaction requiring stockholder approval.**

Upon the completion of the Recapitalization, our Class B common stock was granted ten votes per share, and our Class A common stock, which is the common stock we are offering pursuant to this prospectus, has one vote per share. Following this offering, our Class B stockholders, including our founders, certain of our directors and executive officers, and affiliates, will hold, in the aggregate % of the voting power of our capital stock. The ten-to-one voting ratio between our Class B and Class A common stock, results in the holders of our Class B common stock collectively controlling a majority of the combined voting power of our common stock and therefore being able to control all matters submitted to our stockholders for approval until 2029, or upon the occurrence of a triggering event at which time all shares of our Class B common stock will automatically convert into shares of our Class A common stock, or on an earlier date, as set forth in our Delaware certificate of incorporation.

This concentrated control will limit or preclude your ability to influence corporate matters for the foreseeable future, including the election of directors, amendments of our organizational documents, and any merger, consolidation, sale of all or substantially all of our assets, or other major corporate transaction requiring stockholder approval. In addition, this may prevent or discourage unsolicited acquisition proposals or offers for our capital stock that you may feel are in your best interest as one of our stockholders.

Future transfers by holders of our Class B common stock will generally result in those shares converting to Class A common stock, subject to the specific exceptions set forth in our Delaware certificate of incorporation, such as certain transfers effected for estate planning purposes and between or among our founders. The conversion of Class B common stock to Class A common stock will have the effect, over time, of increasing the relative voting power of those holders of Class B common stock who retain their shares in the long-term. For a description of the dual class structure, see the section entitled "Description of capital stock—Anti-takeover effects of Delaware law and our certificate of incorporation and bylaws."

**Our management has broad discretion in the use of the net proceeds from this offering, and our use of the net proceeds may not enhance our operating results or the price of our Class A common stock.**

We intend to use a portion of our net proceeds that we receive from this offering for the repayment of our existing term loan, which had an outstanding balance of \$52.5 million as of June 30, 2017 and to pay off our revolving credit balance of \$18.0 million as of June 30, 2017. We intend to use the remaining net proceeds we receive from this offering for general corporate purposes, including working capital, sales and marketing activities, application and application enhancement development, acquisition, investment in our technology and analytics, general and administrative matters and capital expenditures. We may use a portion of the net proceeds to acquire complementary businesses, products, services or technologies and to build and develop our new headquarters building. While we do not have agreements or commitments for any specific acquisitions at this time, other than as disclosed elsewhere in this prospectus, we continually evaluate potential acquisition candidates to enhance our product offerings. Accordingly, our management will have considerable discretion over the specific use of the net proceeds that we receive in this offering and might not be able to obtain a significant return, if any, on investment of these net proceeds. You will not have the opportunity as part of your investment decision to assess whether the net proceeds are being used appropriately. Investors in this offering will need to rely upon the judgment of our management with respect to the use of proceeds. Until the net proceeds are used, they may be placed in investments that do not produce significant income, may be held in demand deposit accounts, or in investments intended to be highly liquid that may nevertheless lose value. If we do not use the net proceeds that we receive in this offering effectively, our business and prospects could be harmed, and the market price of our Class A common stock could decline.

***We do not intend to pay dividends in the foreseeable future. As a result, your ability to achieve a return on your investment will depend on appreciation in the price of our Class A common stock.***

We have never declared or paid any cash dividends on our Class A common stock. We currently intend to retain all available funds and any future earnings for use in the operation of our business and do not anticipate paying any dividends on our Class A common stock in the foreseeable future. Any determination to pay dividends in the future will be at the discretion of our board of directors. Consequently, your only opportunity to achieve a return on your investment in our company will be if the market price of our Class A common stock appreciates and you sell your shares at a profit. There is no guarantee that the price of our Class A common stock that will prevail in the market after this offering will ever exceed the price that you pay. For additional information about our dividend policy, see the section entitled "Dividend policy" elsewhere in this prospectus.

***Our management team has limited experience managing a public company.***

Most members of our management team have limited experience managing a publicly-traded company, interacting with public company investors, and complying with laws pertaining to public companies. Our management team may not successfully or efficiently manage our transition to being a public company subject to significant regulatory oversight and reporting obligations under the federal securities laws and the continuous scrutiny of securities analysts and investors. These new obligations and constituents will require significant attention from our senior management and could divert their attention away from the day-to-day management of our business, which could adversely affect our business, financial condition, and operating results.

***We will incur increased costs and devote additional management time as a result of operating as a public company.***

As a public company, we will incur legal, accounting and other expenses that we did not incur as a private company. We will be subject to the reporting requirements of the Securities Exchange Act of 1934, as amended, or the Exchange Act, and will be required to comply with the applicable requirements of the Sarbanes-Oxley Act of 2002, or SOX, and the Dodd-Frank Wall Street Reform and Consumer Protection Act, or Dodd-Frank, as well as rules and regulations subsequently implemented by the SEC and the Nasdaq Global Select Market, including the establishment and maintenance of effective disclosure and financial controls and changes in corporate governance practices. We expect that compliance with these requirements will increase our legal and financial compliance costs and will make some activities more time consuming and costly. In addition, we expect that our management and other personnel will need to divert attention from operational and other business matters to devote additional time to these public company requirements. In particular, we expect to incur additional expenses and devote additional management effort toward ensuring compliance with the requirements of Section 404 of SOX, which will increase when we are no longer an emerging growth company, as defined by the JOBS Act. We may need to hire additional accounting and financial staff with appropriate experience and technical accounting knowledge to support internal auditing. We cannot predict or estimate the amount of additional costs we may incur as a result of becoming a public company or the timing of such costs.

***If we fail to maintain effective internal controls, we may not be able to report financial results accurately or on a timely basis, or to detect fraud, which could have a material adverse effect on our business or share price.***

Effective internal controls are necessary for us to provide reasonable assurance with respect to our financial reports and to effectively prevent financial fraud. Pursuant to SOX, we will be required to periodically evaluate the effectiveness of the design and operation of our internal controls. Internal controls over financial reporting may not prevent or detect misstatements because of inherent limitations, including the possibility of human error or collusion, the circumvention or overriding of controls, or fraud. If we fail to maintain an effective

## [Table of Contents](#)

system of internal controls, our business and operating results could be harmed, and we could fail to meet our reporting obligations, which could have a material adverse effect on our business and our share price.

As a public company, we will be required to maintain internal controls over financial reporting and to report any material weaknesses in such internal controls. Section 404 of SOX requires annual management assessments of the effectiveness of our internal controls over financial reporting beginning with our Annual Report for the year ending December 31, 2018. Both our independent auditors and we will be testing our internal controls pursuant to the requirements of Section 404 of SOX and could, as part of that documentation and testing, identify areas for further attention or improvement. We are in the process of designing, implementing, and testing the internal control over financial reporting required to comply with this obligation, which process is time consuming, costly, and complicated. We have identified material weaknesses in our internal controls over financial reporting for the fiscal years ended December 31, 2015 and 2016. If we identify material weaknesses in our internal control over financial reporting in the future or if we are unable to successfully remediate the identified material weaknesses or, if we are unable to comply with the requirements of Section 404 in a timely manner or assert that our internal control over financial reporting is effective, or if our independent registered public accounting firm is unable to express an opinion as to the effectiveness of our internal control over financial reporting, investors may lose confidence in the accuracy and completeness of our financial reports and the market price of our Class A common stock could be negatively affected, and we could become subject to investigations by the stock exchange on which our securities are listed, the SEC, or other regulatory authorities, which could require additional financial and management resources.

***We are an emerging growth company and we cannot be certain if (i) the reduced disclosure requirements or (ii) extended transition periods for complying with new or revised accounting standards applicable to emerging growth companies will make our common stock less attractive to investors.***

We qualify as an emerging growth company. Under the JOBS Act, emerging growth companies can delay adopting new or revised accounting standards until such time as those standards apply to private companies. Under the JOBS Act, emerging growth companies can delay adopting new or revised accounting standards issued subsequent to the enactment of the JOBS Act until such time as those standards apply to private companies. We have elected to use this extended transition period for complying with new or revised accounting standards that have different effective dates for public and private companies until the earlier of the date we (i) are no longer an emerging growth company, or (ii) affirmatively and irrevocably opt out of the extended transition period provided in the JOBS Act. As a result, our financial statements may not be comparable to companies that comply with new or revised accounting pronouncements as of public company effective dates.

For as long as we continue to be an emerging growth company, we intend to take advantage of certain exemptions from various reporting requirements that are applicable to other public companies including, but not limited to, reduced disclosure obligations regarding executive compensation in our periodic reports and proxy statements and exemptions from the requirements of holding a nonbinding advisory vote on executive compensation and stockholder approval of any golden parachute payments not previously approved. We cannot predict if investors will find our common stock less attractive because we will rely on these exemptions. If some investors find our common stock less attractive as a result, there may be a less active trading market for our common stock and our stock price may be more volatile.

We will remain an emerging growth company until the earliest of (i) the end of the fiscal year in which the market value of our common stock that is held by non-affiliates exceeds \$700 million as of June 30, (ii) the end of the fiscal year in which we have total annual gross revenues of \$1.07 billion or more during such fiscal year, (iii) the date on which we issue more than \$1 billion in non-convertible debt in a three-year period or (iv) the end of the fiscal year that is five years from the date of this prospectus.

***Certain provisions in our charter documents and Delaware law could prevent an acquisition of our company, limit attempts by our stockholders to replace or remove members of our board of directors or current management and may adversely affect the market price of our Class A common stock.***

Our Delaware certificate of incorporation and bylaws contain provisions that could delay or prevent a change in control of our company that stockholders may consider favorable, including transactions in which stockholders might otherwise receive a premium for their shares. These provisions may also prevent or delay attempts by stockholders to replace or remove our current management or members of our board of directors. These provisions include:

- providing for a dual class common stock structure for 15 years following the completion of this offering;
- providing for a classified board of directors with staggered three-year terms, which could delay the ability of stockholders to change the membership of a majority of our board of directors;
- authorizing our board of directors to issue shares of preferred stock and to determine the price and other terms of those shares, including preferences and voting rights, without stockholder approval;
- the requirement that a special meeting of stockholders may be called only by the chairman of our board of directors, our chief executive officer, our president, or a majority vote of our board of directors, which could delay the ability of our stockholders to force consideration of a proposal or to take action, including the removal of directors;
- requiring the affirmative vote of holders of at least 66 <sup>2</sup>/<sub>3</sub>% of the voting power of all of the then outstanding shares of the voting stock, voting together as a single class, to adopt, amend, or repeal provisions of (i) our certificate of incorporation relating to the issuance of preferred stock without stockholder approval, voting rights of our Class A common stock and our Class B common stock, and management of our business, and (ii) our bylaws relating to the ability of stockholders to call a special meeting and amending our bylaws in their entirety, which may inhibit the ability of an acquirer to effect such amendments to facilitate an unsolicited takeover attempt;
- the ability of our board of directors, by majority vote, to amend our bylaws, which may allow our board of directors to take additional actions to prevent an unsolicited takeover and inhibit the ability of an acquirer to amend our bylaws to facilitate an unsolicited takeover attempt; and
- requiring advance notice procedures with which stockholders must comply to nominate candidates to our board of directors or to propose matters to be acted upon at a stockholders' meeting, which may discourage or deter a potential acquirer from conducting a solicitation of proxies to elect the acquirer's own slate of directors or otherwise attempting to obtain control of us.

In addition, as a Delaware corporation, we are subject to Section 203 of the Delaware General Corporation Law. These provisions may prohibit large stockholders, in particular those owning 15% or more of our outstanding voting stock, from merging or combining with us for a certain period of time. See the section entitled "Description of capital stock—Anti-takeover effects of Delaware law and our certificate of incorporation and bylaws."

These and other provisions in our certificate of incorporation, our bylaws and under Delaware law could discourage potential takeover attempts, reduce the price that investors might be willing to pay for shares of our Class A common stock in the future and result in the market price being lower than it would be without these provisions. See the sections entitled "Description of capital stock—Preferred Stock" and "Description of capital stock—Anti-takeover effects of Delaware law and our certificate of incorporation and bylaws."

## Information regarding forward looking statements

This prospectus includes forward-looking statements. All statements other than statements of historical facts contained in this prospectus, including statements regarding our future results of operations and financial position, customer lifetime value, strategy and plans, market size and opportunity, competitive position, industry environment, potential growth opportunities and our expectations for future operations, are forward-looking-statements. The words “believe,” “may,” “will,” “estimate,” “continue,” “anticipate,” “design,” “intend,” “expect,” “could,” “plan,” “potential,” “predict,” “seek,” “should,” “would” or the negative version of these words and similar expressions are intended to identify forward-looking statements. We have based these forward-looking statements on our current expectations and projections about future events and trends that we believe may affect our financial condition, results of operations, strategy, short- and long-term business operations and objectives, and financial needs. The forward-looking statements are contained principally in “Prospectus summary,” “Risk factors,” “Management’s discussion and analysis of financial condition and result of operations” and “Business.”

These forward-looking statements are subject to a number of risks, uncertainties and assumptions, including those described in “Risk factors.” Moreover, we operate in a very competitive and rapidly changing environment. New risks emerge from time to time. It is not possible for our management to predict all risks, nor can we assess the impact of all factors on our business or the extent to which any factor, or combination of factors, may cause actual results to differ materially from those contained in any forward-looking statements we may make. In light of these risks, uncertainties and assumptions, the forward-looking events and circumstances discussed in this prospectus may not occur and actual results could differ materially and adversely from those anticipated or implied in the forward-looking statements.

You should not rely upon forward-looking statements as predictions of future events. Although we believe that the expectations reflected in the forward-looking statements are reasonable, we cannot guarantee that the future results, levels of activity, performance or events and circumstances reflected in the forward-looking statements will be achieved or occur. Moreover, except as required by law, neither we nor any other person assumes responsibility for the accuracy and completeness of the forward-looking statements. We undertake no obligation to update publicly any forward-looking statements for any reason after the date of this prospectus to conform these statements to actual results or to changes in our expectations.

You should read this prospectus and the documents that we reference in this prospectus and have filed with the SEC as exhibits to the registration statement of which this prospectus is a part with the understanding that our actual future results, levels of activity, performance and events and circumstances may be materially different from what we expect.

## Market, industry and other data

We obtained the industry, market and competitive position data used throughout this prospectus from our own internal estimates and research, as well as from industry and general publications, in addition to research, surveys and studies conducted by third parties. Internal estimates are derived from publicly-available information released by industry analysts and third party sources, our internal research and our industry experience, and are based on assumptions made by us based on such data and our knowledge of our industry and market, which we believe to be reasonable. In addition, while we believe the industry, market and competitive position data included in this prospectus is reliable and is based on reasonable assumptions, such data involves risks and uncertainties and are subject to change based on various factors, including those discussed in the section entitled "Risk factors." These and other factors could cause results to differ materially from those expressed in the estimates made by the independent parties and by us.

Information based on estimates, forecasts, projections, market research, or similar methodologies is inherently subject to uncertainties, and actual events or circumstances may differ materially from events and circumstances that are assumed in this information. In some cases, we do not expressly refer to the sources from which data is derived.

Certain information in this prospectus is contained in independent industry publications. The source of these independent industry publications is provided below:

- CIMdata, Inc., *2017 Simulation and Analysis Market Analysis Report, 2017*.
- International Data Corporation, *IDC HPC Update at ISC 16, 2016*.
- International Data Corporation, *Market Forecast Report: Worldwide Business Analytics Software Forecast, 2017*.
- International Data Corporation, *Market Forecast Report: Worldwide Internet of Things Forecast Update, 2016-2020, 2016*.
- \*The Gartner Report described herein (the "Gartner Report") represents research opinion or viewpoints published, as part of a syndicated subscription service, by Gartner, Inc. ("Gartner"), and are not representations of fact. Each Gartner Report speaks as of its original publication date (and not as of the date of this prospectus) and the opinions expressed in the Gartner Report are subject to change without notice. The Gartner Report consists of a Gartner, Inc., *Press Release dated February 7, 2017: "Gartner Says 8.4 Billion Connected 'Things' Will Be in Use in 2017, Up 31 Percent from 2016."*

The independent publications described herein represent research opinions or viewpoints published and are not representations of fact. Each publication speaks as of its original publication date (and not as of the date of this prospectus) and are subject to change without notice.



## Use of proceeds

We estimate that the net proceeds from our sale of \_\_\_\_\_ shares of Class A common stock in this offering at an assumed initial public offering price of \$ \_\_\_\_\_ per share, the midpoint of the price range set forth on the front cover of this prospectus, after deducting estimated underwriting discounts and commissions and estimated offering expenses, will be approximately \$ \_\_\_\_\_ million, or \$ \_\_\_\_\_ million if the underwriters' option to purchase additional shares is exercised in full. A \$1.00 increase (decrease) in the assumed initial public offering price would increase (decrease) the net proceeds to us from this offering by \$ \_\_\_\_\_ million, assuming the number of shares offered by us, as set forth on the front cover of this prospectus, remains the same and after deducting the estimated underwriting discounts and commissions. We will not receive any proceeds from the sale of Class A common stock by the selling stockholders.

We currently intend to use \$ \_\_\_\_\_ million of the net proceeds of this offering to repay our term loan, which had an outstanding balance of \$52.5 million as of June 30, 2017 and to pay off the revolving credit balance under our credit facility as set forth in the Credit Agreement. At June 30, 2017, we were required to make quarterly principal payments on Term Loan A of \$2.5 million in 2017, 2018 and March 2019. Any outstanding principal balance is to be paid in full on the maturity date of April 18, 2019. At December 31, 2015 and 2016, and June 30, 2017, respectively, there was \$67.1 million, \$57.5 million, and \$52.5 million outstanding under Term Loan A at an interest rate of 2.2%, 2.6% and 2.8%. We anticipate entering into a new revolving credit facility upon the closing of this offering and intend to use the above referenced net proceeds to pay the related origination fees and expenses. Please see the section entitled "Management's discussion and analysis of financial condition and results of operations—Liquidity and capital resources—New revolving credit facility."

As of June 30, 2017, the principal amount of the revolving loans outstanding was \$18.0 million. See Note 7 to the financial statements included elsewhere in this prospectus.

We intend to use the remaining net proceeds to us from this offering primarily for general corporate purposes, including real estate development, working capital, sales and marketing activities, general and administrative matters and capital expenditures. We may also use a portion of the net proceeds for the acquisition of, or investment in, technologies, solutions or businesses that complement our business. We will have broad discretion over the uses of the net proceeds in this offering. Pending these uses, we may invest the net proceeds from this offering in short-term, investment-grade interest-bearing securities such as money market accounts, certificates of deposit, commercial paper and guaranteed obligations of the United States government.

By establishing a public market for our Class A common stock, this offering is also intended to facilitate our future access to public markets.

## **Dividend policy**

We have never declared or paid and do not anticipate declaring or paying, any cash dividends on our Class A common stock. We currently intend to retain all available funds and any future earnings for use in the operation of our business. Any future determination to declare dividends will be made at the discretion of our board of directors and will depend on our financial condition, results of operations, capital requirements, general business conditions and other factors that our board of directors may deem relevant.

## Capitalization

The following table shows our cash and cash equivalents and our capitalization as of June 30, 2017 on:

- an actual basis;
- a pro forma basis, giving effect to the reversal of the stock-based compensation liability (see Note 3 to the consolidated financial statements) which will occur upon effectiveness of the registration statement of which this prospectus is a part as if it had occurred on June 30, 2017, and the four-for-one stock split of our common stock effective when we became a Delaware corporation on October 5, 2017, but excluding the 708,000 shares of our Class A common stock issued on September 28, 2017 in connection with our acquisition of Runtime; and
- a pro forma as adjusted basis, giving effect to (i) the pro forma adjustments set forth above, (ii) the receipt of \$ million in net proceeds from the sale and issuance by us of shares of common stock offered by us in this prospectus at an assumed initial public offering price of \$ per share, which is the midpoint of the estimated offering price range set forth on the cover page of this prospectus, after deducting the estimated underwriting discounts and commissions from this offering and estimated offering expenses paid or payable by us and (iii) our use of a portion of our net proceeds from this offering to fully repay our term loan and revolving credit balance under our credit facility, which had an outstanding balance of \$52.5 million and \$18.0 million, respectively, as of June 30, 2017.

You should read the following table in conjunction with “Management’s discussion and analysis of financial condition and results of operations,” “Description of capital stock” and our consolidated financial statements and the related notes appearing elsewhere in this prospectus.

(In thousands, except share and per share data)	As of June 30, 2017		
	Actual	Pro forma	Pro forma as adjusted <sup>(1)</sup>
Cash and cash equivalents	\$ 17,419	\$ 17,419	\$
Credit Agreement:			
Revolving credit facility <sup>(2)</sup>	\$ 18,018	\$ 18,018	
Term Loan A <sup>(2)</sup>	52,500	52,500	
Stockholders’ equity (deficit):			
Preferred stock, \$0.0001 par value per share: no shares authorized, issued and outstanding, actual; 45,000,000 shares authorized, no shares issued or outstanding, pro forma and pro forma as adjusted	—	—	
Class A common stock, \$0.0001 par value per share: 76,000,000 shares authorized, 9,387,512 shares issued and outstanding, actual; 513,796,572 shares authorized, 9,387,512 shares issued and outstanding, pro forma; 513,796,572 shares authorized, shares issued and outstanding, pro forma as adjusted	1	1	
Class B common stock, \$0.0001 par value per share: 44,000,000 shares authorized, 41,203,428 shares issued and outstanding, actual; 41,203,428 shares authorized, 41,203,428 shares issued and outstanding, pro forma; 41,203,428 shares authorized, shares issued and outstanding, pro forma as adjusted	4	4	
Additional paid-in capital	40,884	40,884	
Accumulated deficit	(76,526)	(59,675)	
Accumulated other comprehensive loss	(5,797)	(5,797)	
Total stockholders’ equity (deficit)	(41,434)	(24,583)	
Total capitalization	\$ 29,084	\$ 45,935	\$

## Table of Contents

- (1) The pro forma as adjusted information is illustrative only and will be adjusted based on the actual public offering price and other terms of this offering determined at pricing. Each \$1.00 increase (decrease) in the assumed initial public offering price of \$      per share, the midpoint of the range on the cover of this prospectus, would increase (decrease) our pro forma as adjusted cash and cash equivalents, additional paid-in capital, total stockholders' (deficit) equity and total capitalization by approximately \$      million, assuming that the number of shares offered by us, as set forth on the cover page of this prospectus, remains the same and after deducting the estimated underwriting discounts and commissions payable by us.
- (2) Our credit facility consists of a \$60 million term loan, of which \$52.5 million was outstanding as of June 30, 2017, a \$60 million revolving commitment, of which \$18.0 million was outstanding as of June 30, 2017, and a \$4.0 million ancillary facility.

The total number of shares of our common stock to be outstanding following this offering is based on 9,387,512 shares of our Class A common stock and 41,203,428 shares of our Class B common stock, outstanding as of June 30, 2017, and excludes:

- 6,207,976 shares of our Class A common stock to be reserved for issuance under our 2017 Plan;
- 2,627,920 shares of our Class A common stock reserved for issuance under our 2012 Plan;
- 6,347,840 shares of our Class A common stock issuable upon exercise of stock options outstanding as of June 30, 2017, with an exercise price of \$0.000025, under our 2001 NQSO Plan.
- 2,931,380 shares of our Class A common stock issuable upon exercise of stock options outstanding as of June 30, 2017, with a weighted average exercise price of \$0.64, under our 2001 Incentive and Non-Qualified Stock Option Plan, or 2001 ISO and NQSO Plan (other than the stock options to be exercised by certain of the selling stockholders in connection with this offering, as set forth elsewhere in this prospectus); and
- 2,209,608 shares of our Class A common stock issuable upon exercise of stock options outstanding as of June 30, 2017, with a weighted average exercise price of \$3.73, under our 2012 Plan.

See the section entitled "Executive compensation—Employee benefit and equity compensation plans" and Note 11 in the notes to consolidated financial statements included elsewhere in this prospectus for a description of our equity plans.

## Dilution

If you invest in our Class A common stock, your interest will be diluted to the extent of the difference between the initial public offering price per share of our Class A common stock and the pro forma as adjusted net tangible book value per share of our Class A common stock immediately after this offering. The historical net tangible negative book value of our common stock as of June 30, 2017 was \$(101.2) million, or \$(2.00) per share. Our pro forma net tangible negative book value as of June 30, 2017 was \$(84.3) million, or \$(1.67) per share, taking into account the reversal of the stock-based compensation liability (see Note 3 to the consolidated financial statements) which will occur upon effectiveness, and the four-for-one stock split of our common stock effective when we became a Delaware corporation on October 5, 2017, but excluding the 708,000 shares of our Class A common stock issued on September 28, 2017 in connection with our acquisition of Runtime. Historical net tangible negative book value per share represents our total tangible assets less our total liabilities, divided by the number of shares of outstanding common stock.

After giving effect to the receipt of the net proceeds from our sale of shares of our Class A common stock in this offering at an assumed initial public offering price of \$ \_\_\_\_\_ per share, the midpoint of the price range set forth on the cover page of this prospectus, after deducting underwriting discounts and commissions and estimated offering expenses payable by us, our pro forma as adjusted net tangible book value as of June 30, 2017 would have been \$ \_\_\_\_\_ million, or \$ \_\_\_\_\_ per share. This represents an immediate increase in pro forma as adjusted net tangible book value of \$ \_\_\_\_\_ per share to existing stockholders and an immediate dilution of \$ \_\_\_\_\_ per share to new investors purchasing Class A common stock in this offering.

The following table illustrates this dilution on a per share basis to new investors:

Initial public offering price per share, based on the midpoint of the price range set forth of the cover page of this prospectus.	\$ _____
Pro forma net tangible negative book value per share as of June 30, 2017	\$ _____
Increase in pro forma net tangible book value per share attributable to new investors	_____
Pro forma as adjusted net tangible book value per share after this offering	_____
Dilution per share to new investors in this offering	\$ _____

A \$1.00 increase (decrease) in the assumed initial public offering price of \$ \_\_\_\_\_ per share would increase (decrease) the pro forma net tangible book value, as adjusted to give effect to this offering, by \$ \_\_\_\_\_ per share and the dilution to new investors by \$ \_\_\_\_\_ per share, assuming the number of shares offered by us, as set forth on the cover page of this prospectus, remains the same, and after deducting underwriting discounts and commissions and estimated expenses payable by us. Similarly, each increase (decrease) of one million shares in the number of shares of Class A common stock offered by us would increase (decrease) the pro forma net tangible book value, as adjusted to give effect to this offering, by \$ \_\_\_\_\_ per share and the dilution to new investors by \$ \_\_\_\_\_ per share, assuming the assumed initial public offering price remains the same and after deducting underwriting discounts and commissions and estimated expenses payable by us. If the underwriters exercise their over-allotment option in full, the pro forma net tangible book value per share of our common stock, as adjusted to give effect to this offering, would be \$ \_\_\_\_\_ per share, and the dilution in pro forma net tangible book value per share to investors in this offering would be \$ \_\_\_\_\_ per share of common stock.

## Table of Contents

The table below summarizes as of June 30, 2017, on a pro forma as adjusted basis described above, the number of shares of our common stock, the total consideration and the average price per share (i) paid to us by existing stockholders and (ii) to be paid by new investors purchasing our Class A common stock in this offering at an assumed initial public offering price of \$ per share, the midpoint of the price range set forth on the cover page of this prospectus, before deducting underwriting discounts and commissions and estimated offering expenses:

	<u>Shares purchased</u>		<u>Total consideration</u>		<u>Average price</u>
	<u>Number</u>	<u>Percent</u>	<u>Amount</u>	<u>Percent</u>	<u>per share</u>
Existing stockholders		%	\$	%	\$
New investors					
Totals		100.0%		\$100.0%	

The total number of shares of our common stock to be outstanding following this offering is based on 9,387,512 shares of our Class A common stock and 41,203,428 shares of our Class B common stock, outstanding as of June 30, 2017, and excludes:

- 6,207,976 shares of our Class A common stock to be reserved for issuance under our 2017 Plan;
- 2,627,920 shares of our Class A common stock reserved for issuance under our 2012 Plan;
- 6,347,840 shares of our Class A common stock issuable upon exercise of stock options outstanding as of June 30, 2017, with an exercise price of \$0.000025, under our 2001 NQSO Plan;
- 2,931,380 shares of our Class A common stock issuable upon exercise of stock options outstanding as of June 30, 2017, with a weighted average exercise price of \$0.64, under our 2001 Incentive and Non-Qualified Stock Option Plan, or 2001 ISO and NQSO Plan (other than the stock options to be exercised by certain of the selling stockholders in connection with this offering, as set forth elsewhere in this prospectus); and
- 2,209,608 shares of our Class A common stock issuable upon exercise of stock options outstanding as of June 30, 2017, with a weighted average exercise price of \$3.73, under our 2012 Plan.

Sales by the selling stockholders in this offering will cause the number of shares held by existing stockholders to be reduced to shares, or % of the total number of shares of our common stock outstanding after this offering, and will increase the number of shares held by new investors to shares, or % of the total number of shares of our common stock outstanding after this offering. In addition, if the underwriters' over-allotment option is exercised in full, the number of shares held by the existing stockholders after this offering would be reduced to % of the total number of shares of our common stock outstanding after this offering, and the number of shares held by new investors would increase to shares, or % of the total number of shares of our common stock outstanding after this offering.

To the extent that any outstanding options are exercised, new options are issued under our stock-based compensation plans or we issue additional shares of our common stock in the future, there will be further dilution to investors participating in this offering. If all outstanding options under our 2012 Plan, our 2001 NQSO Plan and our 2001 ISO and NQSO Plan as of June 30, 2017 were exercised, then our existing stockholders, including the holders of these options, would own % and our new investors would own % of the total number of shares of our common stock outstanding upon the completion of this offering. In such event, the total consideration paid by our existing stockholders, including the holders of these options, would be approximately \$ million, or %, the total consideration paid by our new investors would be \$ million, or %, the average price per share paid by our existing stockholders would be \$ and the average price per share paid by our new investors would be \$ .

## Selected historical consolidated financial and other data

The following selected consolidated financial data should be read in conjunction with the section entitled “Management’s discussion and analysis of financial condition and results of operations” and the consolidated financial statements and related notes included within this prospectus. The consolidated statement of operations data for the years ended December 31, 2015 and 2016, and the consolidated balance sheet data as of December 31, 2015 and 2016, are derived from our audited consolidated financial statements and related notes included elsewhere in this prospectus. The consolidated statement of operations data for the six months ended June 30, 2016 and 2017, and the consolidated balance sheet data as of June 30, 2017, are derived from our unaudited consolidated financial statements included elsewhere in this prospectus. We have prepared the unaudited consolidated financial statements on the same basis as the audited consolidated financial statements and have included all adjustments, consisting only of normal recurring adjustments that, in our opinion, are necessary to state fairly the financial information set forth in those statements. Our historical results are not necessarily indicative of our future results and the results of operations for the six months ended June 30, 2017 are not necessarily indicative of the results to be expected for the full fiscal year or any other period. The selected consolidated financial data in this section are not intended to replace our consolidated financial statements and the related notes, and are qualified in their entirety by the consolidated financial statements and related notes included elsewhere in this prospectus.

(in thousands, except share data)	Years ended December 31,		Six months ended June 30,	
	2015	2016	2016	2017
<b>Consolidated Statements of Operations Data:</b>				
<b>Revenue:</b>				
Software	\$205,567	\$223,818	\$106,929	\$113,697
Software related services	37,294	35,770	17,790	17,175
Total software	242,861	259,588	124,719	130,872
Client engineering services	45,075	47,702	24,289	24,594
Other	6,193	5,950	3,332	3,062
Total revenue	294,129	313,240	152,340	158,528
<b>Cost of revenue:</b>				
Software <sup>(1)</sup>	27,406	31,962	15,021	17,633
Software related services	30,079	27,653	13,838	13,773
Total software	57,485	59,615	28,859	31,406
Client engineering services	36,081	38,106	19,207	19,969
Other	5,642	4,879	2,692	2,297
Total cost of revenue	99,208	102,600	50,758	53,672
Gross profit	194,921	210,640	101,582	104,856
<b>Operating expenses:</b>				
Research and development <sup>(1)</sup>	62,777	71,325	34,012	41,608
Sales and marketing <sup>(1)</sup>	63,080	66,086	32,093	36,338
General and administrative <sup>(1)</sup>	54,069	57,202	27,882	37,290
Amortization of intangible assets	2,624	3,322	1,477	2,098
Other operating income	(2,576)	(2,742)	(1,129)	(3,330)
Total operating expense	179,974	195,193	94,335	114,004

## Table of Contents

Operating income (loss)	14,947	15,447	7,247	(9,148)
Interest expense	2,416	2,265	1,247	1,159
Other expense (income), net	782	(520)	(652)	786
Income (loss) before income taxes	11,749	13,702	6,652	(11,093)
Income tax expense (benefit)	818	3,539	2,699	(1,659)
Net income (loss)	\$10,931	\$10,163	3,953	\$ (9,434)
Net income (loss) per share attributable to common stockholders, basic <sup>(2)</sup>	\$ 0.23	\$ 0.21	0.08	\$ (0.19)
Net income (loss) per share attributable to common stockholders, diluted <sup>(2)</sup>	\$ 0.19	\$ 0.18	0.07	\$ (0.19)
Weighted average number of shares used in computing net income (loss) per share attributable to common stockholders, basic <sup>(2)</sup>	46,609	48,852	47,891	50,255
Weighted average number of shares used in computing net income (loss) per share attributable to common stockholders, diluted <sup>(2)</sup>	58,709	57,856	57,236	50,255
Pro forma net income (loss) <sup>(3)</sup>		\$12,341		\$ (3,303)
Pro forma net income (loss) per share attributable to common stockholders, basic <sup>(3)</sup>		\$ 0.25		\$ (0.07)
Pro forma net income (loss) per share attributable to common stockholders, diluted <sup>(3)</sup>		\$ 0.21		\$ (0.07)

(1) Includes stock-based compensation expense as follows:

(in thousands)	Year ended December 31,		Six months ended June 30,	
	2015	2016	2016	2017
Cost of revenue—software	\$ 44	\$ 22	\$ 14	\$ 16
Research and development	149	1,370	41	3,784
Sales and marketing	109	775	35	2,115
General and administrative	295	2,965	85	8,122
Total stock-based compensation expense	\$597	\$5,132	\$ 175	\$ 14,037

(2) See Note 14 in the notes to consolidated financial statements for an explanation of the method used to calculate basic and diluted net income (loss) per share attributable to common stockholders.

(3) The Pro forma amounts reflect the effects of the reversal of the stock-based compensation liability that will occur upon effectiveness (see Note 3 in the notes to consolidated financial statements) but excludes the 708,000 shares of our Class A common stock issued on September 28, 2017 in connection with our acquisition of Runtime.

(in thousands)	As of December 31,		As of June 30,
	2015	2016	2017
<b>Consolidated balance sheet data:</b>			
Cash and cash equivalents	\$ 13,756	\$ 16,874	\$ 17,419
Working capital	(55,097)	(52,902)	(79,313)
Total assets	221,850	250,776	265,610
Deferred revenue, current and non-current	106,516	113,929	136,780
Debt	83,177	85,241	71,095
Total stockholders' deficit	(42,039)	(34,653)	(41,434)



## Key metrics

We monitor the following key non-GAAP financial and operating metrics to help us evaluate our business, measure our performance, identify trends affecting our business, formulate business plans and make strategic decisions. In addition to our results determined in accordance with GAAP, we believe the following non-GAAP financial and operating metrics are useful in evaluating our operating performance.

**Billings.** Billings consists of our total revenue plus the change in our deferred revenue in a given period. As we generally bill our customers at the time of sale, but typically recognize a majority of the related revenue ratably over time, management believes that Billings is a meaningful way to measure and monitor our ability to provide our business with the working capital generated by upfront payments from our customers. While we believe that billings provides valuable insight into the cash that will be generated from sales of our software and services, this metric may vary from period-to-period for a number of reasons including the impact of changes in foreign currency exchange rates and the potential impact of acquisitions.

See the section entitled “Selected historical consolidated financial and other data—Reconciliation of non-GAAP financial measures” for information regarding the limitations of using Billings as a financial measure and for a reconciliation of Billings to revenue, the most directly comparable financial measure calculated in accordance with GAAP.

Our Billings were as follows:

(in thousands)	Year ended		Six months ended	
	December 31,		June 30,	
	2015	2016	2016	2017
Billings	\$297,358	\$320,653	\$165,449	\$181,379

**Adjusted EBITDA.** We define Adjusted EBITDA as net income (loss) adjusted for income tax expense (benefit), interest expense, interest income and other, depreciation and amortization, stock-based compensation expense, restructuring charges, asset impairment charges and other special items as determined by management. We believe that Adjusted EBITDA is a meaningful measure of performance as it is commonly utilized by us and the investment community to analyze operating performance in our industry. See the section entitled “Selected historical consolidated financial and other data—Reconciliation of non-GAAP financial measures” for information regarding the limitations of using Adjusted EBITDA as a financial measure and for a reconciliation of Adjusted EBITDA to net income (loss), the most directly comparable financial measure calculated in accordance with GAAP.

Our Adjusted EBITDA was as follows:

(in thousands)	Year ended		Six months ended	
	December 31,		June 30,	
	2015	2016	2016	2017
Adjusted EBITDA	\$22,949	\$30,830	\$12,933	\$7,056

**Free Cash Flow.** Free Cash Flow is a non-GAAP financial measure that we calculate as cash flow provided by operating activities less capital expenditures. We believe that Free Cash Flow is useful in analyzing our ability to service and repay debt and return value directly to stockholders. See the section entitled “Selected historical consolidated financial and other data—Reconciliation of non-GAAP financial measures” for information regarding the limitations of using Free Cash Flow as a financial measure and for a reconciliation of Free Cash Flow to net cash provided by operating activities, the most directly comparable financial measure calculated in accordance with GAAP.

## [Table of Contents](#)

Our Free Cash Flow was as follows:

(in thousands)	Year ended December 31,		Six months ended June 30,	
	2015	2016	2016	2017
Free Cash Flow	\$5,605	\$11,941	\$18,307	\$21,782

*Recurring Software License Rate.* A key factor to our success is our recurring software license rate which we measure through billings, primarily derived from annual renewals of our existing subscription customer agreements. We calculate our recurring software license rate for a particular period by dividing (i) the sum of software term-based license billings, software license maintenance billings, and 20% of software perpetual license billings which we believe approximates maintenance as an element of the arrangement by (ii) the total software license billings including all term-based, maintenance, and perpetual license billings from all customers for that period. For the years ended December 31, 2015, 2016 and six months ended June 30, 2017, our recurring software license rate was 88%, 90% and 91%, respectively.

These non-GAAP financial measures reflect an additional way of viewing aspects of our business that, when viewed with our GAAP results and the accompanying reconciliations to corresponding GAAP financial measures included in the tables below, may provide a more complete understanding of factors and trends affecting our business. These non-GAAP financial measures should not be relied upon to the exclusion of GAAP financial measures and are by definition an incomplete understanding of the Company and must be considered in conjunction with GAAP measures.

We believe that the non-GAAP measures disclosed herein are only useful as an additional tool to help management and investors make informed decisions about our financial and operating performance and liquidity. By definition, non-GAAP measures do not give a full understanding of the Company. To be truly valuable, they must be used in conjunction with the comparable GAAP measures. In addition, non-GAAP financial measures are not standardized. It may not be possible to compare these financial measures with other companies' non-GAAP financial measures having the same or similar names. We strongly encourage investors to review our consolidated financial statements and the notes thereto in their entirety and not to rely on any single financial measure.

### Reconciliation of non-GAAP financial measures

The following tables provide reconciliations of revenue to Billings, income (loss) before income taxes to Adjusted EBITDA and net cash provided by operating activities to Free Cash Flow:

#### Billings

(in thousands)	Year ended December 31,		Six months ended June 30,	
	2015	2016	2016	2017
Revenue	\$ 294,129	\$ 313,240	\$ 152,340	\$ 158,528
Ending deferred revenue	106,516	113,929	119,625	136,780
Beginning deferred revenue	(103,287)	(106,516)	(106,516)	(113,929)
Billings	\$ 297,358	\$ 320,653	\$ 165,449	\$ 181,379

[Table of Contents](#)**Adjusted EBITDA**

<b>(in thousands)</b>	<b>Year Ended December 31,</b>		<b>Six months ended June 30,</b>	
	<b>2015</b>	<b>2016</b>	<b>2016</b>	<b>2017</b>
Net income (loss)	\$10,931	\$10,163	\$ 3,953	\$ (9,434)
Income tax expense (benefit)	818	3,539	2,699	(1,659)
Stock-based compensation	597	5,132	175	14,037
Interest expense	2,416	2,265	1,247	1,159
Interest income and other <sup>(1)</sup>	(191)	(249)	12	(2,131)
Depreciation and amortization	8,378	9,980	4,847	5,084
Adjusted EBITDA	\$22,949	\$30,830	\$ 12,933	\$ 7,056

(1) Includes a non-recurring adjustment for a change in estimated legal expenses resulting in \$2 million of income for the six months ended June 30, 2017.

**Free Cash Flow**

<b>(in thousands)</b>	<b>Year ended December 31,</b>		<b>Six months ended June 30,</b>	
	<b>2015</b>	<b>2016</b>	<b>2016</b>	<b>2017</b>
Net cash provided by operating activities	\$10,838	\$ 21,385	\$ 22,006	\$ 26,117
Capital expenditures	(5,233)	(9,444) <sup>(1)</sup>	(3,699)	(4,335)
Free Cash Flow	\$ 5,605	\$ 11,941	\$ 18,307	\$ 21,782

(1) Includes \$4.0 million purchase of real property adjacent to our corporate headquarters.

# Management's discussion and analysis of financial condition and results of operations

*The following discussion and analysis of our financial condition and results of operations should be read in conjunction with the "Selected historical consolidated financial and other data" and our financial statements and related notes included elsewhere in this prospectus. This discussion contains forward-looking statements that involve risks and uncertainties. Our actual results could differ materially from those discussed below. Factors that could cause or contribute to such differences include, but are not limited to, those identified below and those discussed in "Risk factors" and "Information regarding forward looking statements" included elsewhere in this prospectus.*

## Vision

Our vision is to transform product design and organizational decision making by applying simulation, optimization and high performance computing throughout product lifecycles.

## Overview

We are a leading provider of enterprise-class engineering software enabling innovation across the entire product lifecycle from concept design to in-service operation. Our simulation-driven approach to innovation is powered by our broad portfolio of high-fidelity and high performance physics solvers. Our integrated suite of software optimizes design performance across multiple disciplines encompassing structures, motion, fluids, thermal management, electromagnetics, system modeling and embedded systems, while also providing data analytics and true-to-life visualization and rendering.

Our engineering and design platform offers a wide range of multi-disciplinary computer aided engineering, or CAE, solutions which we believe is one of the most innovative and comprehensive offerings available in the market. To ensure customer success and deepen our relationships with them, we engage with our customers to provide consulting, implementation services, training, and support, especially when applying optimization. We participate in five software categories related to CAE and high performance computing, or HPC:

- Solvers & Optimization;
- Modeling & Visualization;
- Industrial & Concept Design;
- Internet of Things, or IoT; and
- HPC.

Altair also provides client engineering services, or CES, to support our customers with long-term ongoing product design and development expertise. This has the benefit of embedding us within customers, deepening our understanding of their processes, and allowing us to more quickly perceive trends in the overall market. Our presence at our customers' sites helps us to better tailor our software products' research and development, or R&D, and sales initiatives.

## ***Our business model***

We pioneered a patented units-based licensing subscription model for software and other digital content. Our customers license a pool of units for their organizations, which allows individual users within the organization

## [Table of Contents](#)

to have flexible and shared access to our entire portfolio of software applications, along with over 150 partner products. We believe our units-based subscription licensing model lowers barriers to adoption, creates broad engagement, encourages users to work within our ecosystem, and increases revenue. This, in turn, helps drive our recurring software license rate which has been on average approximately 88% over the past five years. Each year approximately 60% of new revenue comes from expansion within existing customers.

### ***Our corporate history and culture***

We were founded in 1985 in Michigan and have a balanced global footprint, with 68 offices in 24 countries, and over 2,000 engineers, scientists and creative thinkers. We believe a critical component of our success has been our company culture, based on our core values of innovation, envisioning the future, communicating honestly and broadly, seeking technology and business firsts, and embracing diversity. This culture is important because it helps attract and retain top people, encourages innovation and teamwork, and enhances our focus on achieving Altair's corporate objectives.

### **Factors affecting our performance**

We believe that our future success will depend on many factors, including those described below. While these areas present significant opportunity, they also present risks that we must manage to achieve successful results. If we are unable to address these challenges, our business, operating results and prospects could be harmed. See the section entitled "Risk factors" included elsewhere in this prospectus.

### ***Seasonality and quarterly results***

Our billings have historically been highest in the first and fourth quarters of any calendar year and may vary in future quarters. The timing of recording billings and the corresponding effect on our cash flows may vary due to the seasonality of the purchasing patterns of our customers. In addition, the timing of the recognition of revenue, the amount and timing of operating expenses including, employee compensation, sales and marketing activities, and capital expenditures, may vary from quarter-to-quarter which may cause our reported results to fluctuate significantly. In addition, we may choose to grow our business for the long-term rather than to optimize for profitability or cash flows for a particular shorter term period. This seasonality or the occurrence of any of the factors above may cause our results of operations to vary and our financial statements may not fully reflect the underlying performance of our business.

### ***Foreign currency fluctuations***

Because of our substantial international operations, we are exposed to foreign currency risks that arise from our normal business operations, including in connection with our transactions that are denominated in foreign currencies, including the Euro, British Pound Sterling, Indian Rupee, Japanese Yen, and Chinese Yuan. To present the changes in our underlying business without regard to the impact of currency fluctuations, we evaluate certain of our operating results both on an as reported basis, as well as on a constant currency basis.

Constant currency amounts exclude the effect of foreign currency fluctuations on our reported results. Our comparative financial results were impacted by fluctuations in the value of the United States dollar relative to other currencies during the six months ended June 30, 2017 as compared to the six months ended June 30, 2016. To present this information, the results for 2017 for entities whose functional currency is a currency other than the United States dollar were converted to United States dollars at rates that were in effect for 2016. These adjusted amounts are then compared to our current period reported amounts to provide operationally driven variances in our results.

## [Table of Contents](#)

The effects of currency fluctuations on our Revenue and Adjusted EBITDA are reflected in the table below. Amounts in brackets indicate a net adverse impact from currency fluctuations.

<b>(in thousands)</b>	<b>Six months ended June 30, 2017</b>
Revenue	\$ (2,253)
Adjusted EBITDA	\$ (916)

### ***Expanded use of our software applications***

Our ability to grow our revenue is affected, in part, by the pace at which our customers continue to expand their use of our design, simulation, optimization and analysis applications and the degree to which prospective customers realize the benefit of using our software applications. To grow our presence within our customers and attract new customers, we devote substantial sales and marketing resources to drive increased adoption across our existing customers and encourage new customers to commence using our software. As a result of this “land and expand” business model, we expect to generate additional revenue from our current and future customer base. To the extent our sales and marketing efforts do not translate into customer retention or expansion, or if we do not allocate those expenses efficiently, our financial performance may be adversely affected. Therefore, our financial performance will depend in part on the degree to which our “land and expand” strategies are successful.

### ***Investments for growth***

We have made and plan to continue to make investments for long-term growth, including investments in our ongoing research and development activities seeking to create new software and to enhance our existing applications to address emerging technology trends and additional customer needs. Generally, the development of new or improved applications in our software can result in the expansion of our user base within an organization and a potential increase in revenue over time, although the expenditures associated with such developments may adversely affect our performance in the near term. We intend to continue to invest resources in sales and marketing, by further expanding our sales teams and increasing our marketing activities. Our ability to continue to grow revenue from our current and potential customer base is dependent, in part, upon the success of our current and future research and development and sales and marketing activities.

## **Business Segments**

We have identified two reportable segments: Software and Client Engineering Services:

- *Software*—our Software segment includes software and software related services. The software component of this segment includes our portfolio of software products including our solvers and optimization technology products, modeling and visualization tools, industrial and concept design tools, IoT platform and analytics tools, and high performance computing, or HPC, software applications, as well as support and the complementary software products we offer through our Altair Partner Alliance, or APA. The APA includes technologies ranging from computational fluid dynamics and fatigue to manufacturing process simulation and cost estimation. The software related services component of this segment includes consulting, implementation services, and training focused on product design and development expertise and analysis from the component level up to complete product engineering.
- *Client Engineering Services*—our client engineering services, or CES, segment provides client engineering services to support our customers with long-term, ongoing product design and development expertise. We

## [Table of Contents](#)

operate our CES business by hiring engineers for placement at a customer site for specific customer-directed assignments. We employ and pay the engineers only for the duration of the placement.

Our other businesses which do not meet the criteria to be separate reportable segments are combined and reported as "Other" which represents innovative services and products, including toggled, our LED lighting and IoT business. toggled is focused on developing and selling next-generation solid state lighting technology along with communication and control protocols based on our intellectual property for the direct replacement of fluorescent light tubes with LED lamps. Other businesses combined within Other include potential services and product concepts that are still in their development stages.

For additional information about our reportable segments and other businesses, see Note 19 in the notes to consolidated financial statements included elsewhere in this prospectus.

## **Components of results of operations**

### **Revenue**

We primarily derive revenue from our units-based subscription licensing model for software and other digital content, other software licensing, and software related services. Our CES business derives revenue from providing engineers to support our customers' long-term, ongoing product design and development projects.

### *Software Segment*

Software segment revenue consists of revenue from software licenses and software related services including consulting, implementation services, training, and support.

### Software

Software revenue is principally comprised of subscription license agreements, typically with 12 month terms, which include maintenance and support. Software revenue is also comprised of perpetual license agreements, and associated maintenance and support agreements. We generally recognize software license revenue ratably over the period of the arrangement. Each year approximately 60% of our new revenue comes from expansion within existing customers.

### Software related services

Software related services includes consulting, implementation services and training. Our software related services team is comprised of almost 700 highly technical people globally. We focus on establishing a strong working relationship with the user community allowing us to offer guidance and expertise throughout their product creation process.

We generally recognize revenue for software related services on a time and materials or, for fixed price arrangements, on a proportional performance basis.

### *Client engineering services segment*

We provide CES to support our customers with long-term, ongoing product design and development expertise. We operate our CES business by hiring engineers for placement at a customer site for specific customer-directed assignments. We employ and pay the engineers only for the duration of the placement.

## [Table of Contents](#)

Our CES business generates revenue from placing simulation specialists, industrial designers, design engineers, materials experts, development and test engineers, manufacturing engineers and information technology specialists on-site with our customers in businesses operating in the virtual simulation, product design and development, software development, and high-performance computing spaces. We recognize CES revenue based upon hours worked and contractually agreed-upon hourly rates.

The average CES assignment was 1.8 years during the period from 2011 through 2016, with a current average length of service for all CES employees of 2.4 years. As of December 31, 2016, 44% of CES employees were in their assignments for over two years. The terms of our CES arrangements generally provide that our customers pay us within 30 days of invoice. The amount and timing of CES revenue depends on our customers demand for engineering services and the number of available qualified employees to service our customers' needs.

### *Other*

Our Other revenue consists primarily of revenue related to our LED lighting business operated out of our wholly-owned subsidiary, toggled. toggled designs, sources through contract manufacturers, and assembles in our own facilities, LED lighting and related products for sale to consumers and businesses. We also generate revenue through royalties from licensing our technology to third party manufacturers and resellers.

## **Cost of revenue**

### *Software segment*

Cost of software revenue consists of expenses related to software licensing and customer support. Significant expenses include employee related costs for support team members, travel costs, and royalties for third-party software products available to customers through our products or as part of our APA.

### Software

Cost of software revenue consists of the cost of personnel and related costs such as salaries, benefits, bonuses and stock-based compensation, travel expenses and certain data center and facility costs and substantially all royalty expenses.

### Software related services

Cost of software related services revenue consists of the cost of personnel and related costs such as salaries, benefits, bonuses and stock-based compensation, travel expenses and certain data center and facility costs.

### *Cost of client engineering services*

Cost of engineering services revenue consists primarily of employee compensation costs. We operate our CES business by hiring engineers for placement at a customer site for specific customer-directed assignments. We employ and pay the engineers only for the duration of the placement.

### *Cost of other*

Cost of other revenue includes the cost of LED lighting products and freight related to products sold to retail and commercial sales channels.



### **Operating expenses**

Operating expenses, as defined and discussed below, support all of the products and services that we provide to our customers and, as a result, they are presented in an aggregate total.

#### *Research and development*

Research and development expenses consist primarily of expenses of our development team, including salaries, benefits, bonuses, stock-based compensation expense and allocated overhead costs. Our research and development efforts are focused on enhancing the functionality, breadth and scalability of our software, addressing new use cases, and developing additional innovative simulation technologies. Timely development of new products is essential to maintaining our competitive position, and we release new versions of our software on a regular basis. All software development costs are expensed as incurred as our current software development process is essentially completed concurrent with the establishment of technological feasibility.

#### *Sales and marketing*

Sales and marketing expenses consist primarily of the cost of personnel and related costs associated with our sales and marketing staff, including salaries, benefits, bonuses, commissions and stock-based compensation, and costs relating to our marketing and business development programs including trade shows and events. We intend to continue to invest resources in our sales and marketing initiatives in order to continue to drive growth and extend our market position.

#### *General and administrative*

General and administrative expenses consist of personnel costs and related expenses for executive, finance, legal, human resources, recruiting, and employee-related information technology and administrative personnel, including salaries, benefits, bonuses and stock-based compensation expense, professional fees for external legal, accounting, facilities, recruiting and other consulting services, allocated overhead costs, and legal settlements.

#### *Amortization of intangible assets*

Amortization of intangible assets consists primarily of amortization of intangibles associated with acquisitions. We expect to incur additional amortization expenses resulting from future strategic acquisitions.

#### *Other operating income*

Other operating income consists primarily of government subsidies, primarily in France, in the form of grant income associated with certain of our research and development activities.

#### *Interest expense*

Interest expense consists of interest expense on our outstanding indebtedness and accretion of interest expense on debt issuance costs. In connection with this offering, we intend to repay substantially all our outstanding indebtedness.

#### *Other expense (income), net*

Other expense (income), net is comprised primarily of foreign currency exchange gains and losses generated from the settlement and remeasurement of transactions denominated in currencies other than the functional currency of our operating units.

## [Table of Contents](#)

### *Income tax expense (benefit)*

Income tax expense (benefit) is comprised primarily of income taxes related to United States, foreign, and state jurisdictions in which we conduct business. We record interest and penalties related to income tax matters as income tax expense. We expect the amount of income tax expense (benefit), if any, to vary each reporting period depending upon fluctuations in our income. We have substantial United States tax credit carryforwards which, if not utilized, will begin to expire in 2018. The ability to utilize these tax credit carryforwards is highly dependent upon our ability to generate taxable income in the United States in the future.

Our future effective annual tax rate may be materially impacted by the amount of benefits and charges from tax amounts associated with our foreign earnings that are taxed at rates different from the federal statutory rate, changes in valuation allowances, level of profit before tax, accounting for uncertain tax positions, stock-based compensation, business combinations, closure of statute of limitations, or settlements of tax audits, and changes in tax laws including possible United States tax law changes that, if enacted, could significantly impact how United States multinational companies are taxed on foreign subsidiary earnings. A significant amount of our earnings is generated in the EMEA and APAC regions. Our future effective tax rates may be adversely affected to the extent earnings are lower than anticipated in countries where we have lower statutory tax rates or we repatriate certain foreign earnings on which United States taxes have not previously been provided.

As of December 31, 2016 and June 30, 2017, we had net deferred tax assets, or DTAs, of \$61.5 million and \$65.8 million, respectively, primarily related to tax credits, share-based compensation, deferred revenue, and capitalized research and development expenses. We are also entitled to a United States federal tax deduction when non-qualified stock options, or NSOs, are exercised. In connection with this offering, we expect a significant number of our NSOs will be exercised, creating substantial additional tax deductions for us. These deductions are expected to result in future net operating losses for United States tax purposes which are expected to result in our needing to establish a valuation allowance for the majority of our DTAs. Our ability to utilize any net operating losses or tax credits could be limited under provisions of the Code if we undergo an ownership change in connection with or after this offering (generally defined as a greater than 50-percentage point cumulative change (by value) in the equity ownership of certain stockholders over a rolling three-year period). It is also possible that we will be unable to realize our tax credit carryforwards as they begin to expire in 2018.

## Results of operations

The following table sets forth our results of operations and the period-over-period percentage change in certain financial data for the years ended December 31, 2015 and 2016 and the six months ended June 30, 2016 and 2017:

(dollars in thousands)	Year ended December 31,		Change %	Six months ended June 30,		Change %
	2015	2016		2016	2017	
<b>Revenue:</b>						
Software	\$205,567	\$223,818	9%	\$106,929	\$113,697	6%
Software related services	37,294	35,770	(4%)	17,790	17,175	(3%)
Total software	242,861	259,588	7%	124,719	130,872	5%
Client engineering services	45,075	47,702	6%	24,289	24,594	1%
Other	6,193	5,950	(4%)	3,332	3,062	(8%)
Total revenue	294,129	313,240	6%	152,340	158,528	4%
<b>Cost of revenue:</b>						
Software	27,406	31,962	17%	15,021	17,633	17%
Software related services	30,079	27,653	(8%)	13,838	13,773	—%
Total software	57,485	59,615	4%	28,859	31,406	9%
Client engineering services	36,081	38,106	6%	19,207	19,969	4%
Other	5,642	4,879	(14%)	2,692	2,297	(15%)
Total cost of revenue	99,208	102,600	3%	50,758	53,672	6%
Gross profit	194,921	210,640	8%	101,582	104,856	3%
<b>Operating expenses:</b>						
Research and development	62,777	71,325	14%	34,012	41,608	22%
Sales and marketing	63,080	66,086	5%	32,093	36,338	13%
General and administrative	54,069	57,202	6%	27,882	37,290	34%
Amortization of intangible assets	2,624	3,322	27%	1,477	2,098	42%
Other operating income	(2,576)	(2,742)	6%	(1,129)	(3,330)	195%
Total operating expenses	179,974	195,193	8%	94,335	114,004	21%
Operating income (loss)	14,947	15,447	3%	7,247	(9,148)	NM
Interest expense	2,416	2,265	(6%)	1,247	1,159	(7%)
Other expense (income), net	782	(520)	NM	(652)	786	NM
Income (loss) before income taxes	11,749	13,702	17%	6,652	(11,093)	NM
Income tax expense (benefit)	818	3,539	333%	2,699	(1,659)	NM
Net income (loss)	\$ 10,931	\$ 10,163	(7%)	\$ 3,953	\$ (9,434)	NM
<b>Other financial information:</b>						
Billings <sup>(1)</sup>	\$297,358	\$320,653	8%	\$165,449	\$181,379	10%
Adjusted EBITDA <sup>(2)</sup>	\$ 22,949	\$ 30,830	34%	\$ 12,933	\$ 7,056	(45%)
Net cash provided by operating activities	\$ 10,838	\$ 21,385	97%	\$ 22,006	\$ 26,117	19%
Free Cash Flow <sup>(3)</sup>	\$ 5,605	\$ 11,941	113%	\$ 18,307	\$ 21,782	19%

NM=Not meaningful.

(1) Billings consists of our total revenue plus the change in our deferred revenue. For more information about Billings and our other non-GAAP financial measures and reconciliations of our non-GAAP financial measures to the most directly comparable financial measures calculated and presented in accordance with GAAP, see the section entitled "Selected historical consolidated financial and other data—Reconciliation of non-GAAP financial measures."

## Table of Contents

- (2) We define Adjusted EBITDA as net income (loss) adjusted for income tax expense (benefit), interest expense, interest income and other, depreciation and amortization, stock-based compensation expense, restructuring charges, asset impairment charges and other special items as determined by management. For more information about Adjusted EBITDA and our other non-GAAP financial measures and reconciliations of our non-GAAP financial measures to the most directly comparable financial measure calculated and presented in accordance with GAAP, see the section entitled "Selected historical consolidated financial and other data—Reconciliation of non-GAAP financial measures."
- (3) We define Free Cash Flow as net cash provided by operating activities less capital expenditures. See the section entitled "Selected historical consolidated financial and other data—Reconciliation of non-GAAP financial measures" for a reconciliation of Free Cash Flow.

The following table sets forth our revenue growth on a constant currency basis for the year ended December 31, 2016 compared to the year ended December 31, 2015, and the six months ended June 30, 2017 compared to the six months ended June 30, 2016:

(dollars in thousands)	Year ended December 31,		Change %	Constant currency change <sup>(1)</sup> %	Six months ended June 30,		Change %	Constant currency change <sup>(1)</sup> %
	2015	2016			2016	2017		
<b>Revenue:</b>								
Software	\$205,567	\$223,818	9%	9%	\$106,929	\$113,697	6%	8%
Software related services	37,294	35,770	(4%)	(3%)	17,790	17,175	(3%)	(1%)
Total software	242,861	259,588	7%	7%	124,719	130,872	5%	7%
Client engineering services	45,075	47,702	6%	6%	24,289	24,594	1%	1%
Other	6,193	5,950	(4%)	(4%)	3,332	3,062	(8%)	(8%)
Total revenue	\$294,129	\$313,240	6%	7%	\$152,340	\$158,528	4%	6%

- (1) The results for entities whose functional currency is a currency other than the United States dollar were converted to United States dollars at rates that were in effect for the corresponding period of the prior year.

## Six months ended June 30, 2016 and 2017

### Revenue

Total revenue increased by \$6.2 million, or 4%, for the six months ended June 30, 2017 as compared to the six months ended June 30, 2016. The increase was primarily attributable to an increase in subscription and software revenue.

### Software segment

#### Software

(in thousands)	Six months ended June 30,		Period-to-period change	
	2016	2017	\$	%
Software revenue	\$106,929	\$113,697	\$ 6,768	6%
As a percent of software segment revenue	86%	87%		
As a percent of consolidated revenue	70%	72%		

The 6% increase in our software revenue for the six months ended June 30, 2017, as compared to the six months ended June 30, 2016, was primarily the result of an expansion in the number of units licensed by our existing customers under renewed software license agreements and, to a lesser extent, licensing of units to new customers pursuant to new software license agreements.

[Table of Contents](#)Software related services

(in thousands)	Six months ended June 30,		Period-to-period change	
	2016	2017	\$	%
Software related services revenue	\$ 17,790	\$ 17,175	\$ (615)	(3%)
As a percent of software segment revenue	14%	13%		
As a percent of consolidated revenue	12%	11%		

The 3% decrease in our software related services revenue for the six months ended June 30, 2017 as compared to the six months ended June 30, 2016, was primarily the result of our continued focus on higher-value projects aligned with our software products, and the completion of projects that had been in process.

*Client engineering services segment*

(in thousands)	Six months ended June 30,		Period-to-period change	
	2016	2017	\$	%
Client engineering services revenue	\$ 24,289	\$ 24,594	\$ 305	1%
As a percent of consolidated revenue	16%	16%		

CES revenue increased \$0.3 million, or 1%, for the six months ended June 30, 2017, as compared to the six months ended June 30, 2016.

*Other*

(in thousands)	Six months ended June 30,		Period-to-period change	
	2016	2017	\$	%
Other revenue	\$ 3,332	\$ 3,062	\$ (270)	(8%)
As a percent of consolidated revenue	2%	2%		

Other revenue decreased \$0.3 million, or 8%, for the six months ended June 30, 2017 as compared to the six months ended June 30, 2016, primarily due to decreased sales prices with our largest distributor of lighting products.

**Cost of revenue***Software segment*Software

(in thousands)	Six months ended June 30,		Period-to-period change	
	2016	2017	\$	%
Cost of software revenue	\$ 15,021	\$ 17,633	\$ 2,612	17%
As a percent of software revenue	14%	16%		
As a percent of consolidated revenue	10%	11%		

Cost of software revenue increased by \$2.6 million, or 17%, for the six months ended June 30, 2017, as compared to the six months ended June 30, 2016. This increase was primarily attributable to higher employee

## [Table of Contents](#)

costs of \$1.1 million as a result of annual compensation adjustments and the addition of new personnel in connection with 2016 acquisitions, and increased third party royalty costs of \$0.6 million for software programs.

### Software related services

(in thousands)	Six months ended June 30,		Period-to-period change	
	2016	2017	\$	%
Cost of software related services revenue	\$ 13,838	\$ 13,773	\$ (65)	—%
As a percent of software related services revenue	78%	80%		
As a percent of consolidated revenue	9%	9%		

Cost of software related services revenue was consistent for the six months ended June 30, 2017 as compared to the six months ended June 30, 2016.

### Client engineering services segment

(in thousands)	Six months ended June 30,		Period-to-period change	
	2016	2017	\$	%
Cost of client engineering services revenue	\$ 19,207	\$ 19,969	\$ 762	4%
As a percent of client engineering services segment revenue	79%	81%		
As a percent of consolidated revenue	13%	13%		

Cost of CES revenue increased by \$0.8 million, or 4%, for the six months ended June 30, 2017, as compared to the six months ended June 30, 2016. This increase is primarily due to compensation expenses associated with placements to meet customer demand and compensation increases to the CES staff in advance of when those costs can be passed through to our CES clients.

### Other

(in thousands)	Six months ended June 30,		Period-to-period change	
	2016	2017	\$	%
Cost of other revenue	\$ 2,692	\$ 2,297	\$ (395)	(15%)
As a percent of other revenue	81%	75%		
As a percent of consolidated revenue	2%	1%		

Cost of other revenue decreased by \$0.4 million, or 15%, for the six months ended June 30, 2017, as compared to the six months ended June 30, 2016. This decrease is primarily due to our introduction of new products that have a lower average cost than the older products.

### Gross profit

(in thousands)	Six months ended June 30,		Period-to-period change	
	2016	2017	\$	%
Gross profit	\$101,582	\$104,856	\$ 3,274	3%
As a percent of consolidated revenue	67%	66%		

## [Table of Contents](#)

Gross profit increased by \$3.3 million, or 3%, for the six months ended June 30, 2017, as compared to the six months ended June 30, 2016. This increase in gross profit was primarily attributable to the growth of our software revenue of \$6.8 million driven by the expansion in the number of units purchased by our existing customers and, to a lesser extent, sales to new customers. The increase in revenue was partially offset by the increase in cost of revenues as described above.

### **Operating expenses**

Operating expenses, as discussed below, support all the products and services that we provide to our customers and, as a result, they are reported and discussed here in an aggregate total.

#### *Research and development*

<b>(in thousands)</b>	<b>Six months ended June 30,</b>		<b>Period-to-period change</b>	
	<b>2016</b>	<b>2017</b>	<b>\$</b>	<b>%</b>
Research and development	\$ 34,012	\$ 41,608	\$ 7,596	22%
As a percent of consolidated revenue	22%	26%		

Research and development expenses increased by \$7.6 million, or 22%, for the six months ended June 30, 2017, as compared to the six months ended June 30, 2016. This increase is attributable to higher employee costs of \$3.7 million resulting from an increase in our headcount, primarily due to acquisitions and annual compensation adjustments. In addition, the stock-based compensation expense component of our research and development expense increased during the six months ended June 30, 2017 by \$3.7 million as compared to the six months ended June 30, 2016 primarily due to the increased value of our shares of common stock.

#### *Sales and marketing*

<b>(in thousands)</b>	<b>Six months ended June 30,</b>		<b>Period-to-period change</b>	
	<b>2016</b>	<b>2017</b>	<b>\$</b>	<b>%</b>
Sales and marketing	\$ 32,093	\$ 36,338	\$ 4,245	13%
As a percent of consolidated revenue	21%	23%		

Sales and marketing expenses increased by \$4.2 million, or 13%, for the six months ended June 30, 2017, as compared to the six months ended June 30, 2016. This increase is primarily attributable to a \$3.2 million increase in employee compensation costs, including stock-based compensation expense of \$2.1 million, and a \$0.7 million increase in sales and marketing campaigns to support our direct sales force.

#### *General and administrative*

<b>(in thousands)</b>	<b>Six months ended June 30,</b>		<b>Period-to-period change</b>	
	<b>2016</b>	<b>2017</b>	<b>\$</b>	<b>%</b>
General and administrative	\$ 27,882	\$ 37,290	\$ 9,408	34%
As a percent of consolidated revenue	18%	24%		

General and administrative expenses increased by \$9.4 million, or 34%, for the six months ended June 30, 2017 as compared to the six months ended June 30, 2016. This increase is primarily attributable to an \$8.9 million increase in employee compensation cost, including stock-based compensation expense of \$8.0 million.

## [Table of Contents](#)

Excluding the impact of stock-based compensation, general and administrative expenses increased by 5%, primarily from annual compensation adjustments, from \$27.8 million to \$29.2 million for the six months ended June 30, 2017 and 2016, respectively.

### *Amortization of intangible assets*

<b>(in thousands)</b>	<b>Six months ended June 30,</b>		<b>Period-to-period change</b>	
	<b>2016</b>	<b>2017</b>	<b>\$</b>	<b>%</b>
Amortization of intangible assets	\$ 1,477	\$ 2,098	\$ 621	42%
As a percent of consolidated revenue	1%	1%		

Amortization of intangible assets increased by \$0.6 million for the six months ended June 30, 2017 as compared to the six months ended June 30, 2016. This increase was attributable to the amortization of intangible assets associated with acquisitions completed during the year ended December 31, 2016.

### *Other operating income*

<b>(in thousands)</b>	<b>Six months ended June 30,</b>		<b>Period-to-period change</b>	
	<b>2016</b>	<b>2017</b>	<b>\$</b>	<b>%</b>
Other operating income	\$ (1,129)	\$ (3,330)	\$ 2,201	195%
As a percent of consolidated revenue	1%	2%		

Other operating income increased \$2.2 million, or 195%, for the six months ended June 30, 2017 as compared to the six months ended June 30, 2016. This increase was due to an increase in grant income as a result of an acquisition in the second quarter of 2016 and a non-recurring adjustment for a change in estimated legal expenses resulting in \$2 million for the six months ended June 30, 2017.

### *Interest expense*

<b>(in thousands)</b>	<b>Six months ended June 30,</b>		<b>Period-to-period change</b>	
	<b>2016</b>	<b>2017</b>	<b>\$</b>	<b>%</b>
Interest expense	\$ 1,247	\$ 1,159	\$ (88)	(7%)
As a percent of consolidated revenue	1%	1%		

Interest expense decreased by \$0.1 million, or 7%, for the six months ended June 30, 2017, as compared to the six months ended June 30, 2016. This decrease was due to a reduction in our interest expense related to our Credit Agreement as a result of a reduction in outstanding debt, partially offset by slightly higher rates based upon Libor interest rate based borrowings.

### *Other (income) expense, net*

<b>(in thousands)</b>	<b>Six months ended June 30,</b>		<b>Period-to-period change</b>	
	<b>2016</b>	<b>2017</b>	<b>\$</b>	<b>%</b>
Other (income) expense, net	\$ (652)	\$ 786	\$ 1,438	NM
As a percent of consolidated revenue	—%	—%		



## [Table of Contents](#)

Other (income) expense, net increased by \$1.4 million for the six months ended June 30, 2017, as compared to the six months ended June 30, 2016. This increase was due to fluctuations in the United States dollar relative to other functional currencies during the six months ended June 30, 2017, compared to the six months ended June 30, 2016.

### *Income tax expense (benefit)*

<b>(in thousands)</b>	<b>Six months ended June 30,</b>		<b>Period-to-period change</b>	
	<b>2016</b>	<b>2017</b>	<b>\$</b>	<b>%</b>
Income tax expense (benefit)	\$ 2,699	\$ (1,659)	\$ (4,358)	NM

The effective tax rate was 15% and 41% for the six months ended June 30, 2017 and 2016, respectively. The tax rate is affected by the Company being a United States resident taxpayer, the tax rates in the United States and other jurisdictions in which the Company operates, the relative amount of income earned by jurisdiction and the relative amount of losses or income for which no benefit or expense is recognized. The effective tax rate was impacted by the geographic income mix in 2017 as compared to 2016, primarily related to the United States pre-tax income of \$7.2 million in 2016 compared to a \$14.9 million pre-tax loss in 2017, and nondeductible stock-based compensation in the amount of \$0.1 million in 2016 compared to \$9.3 million in 2017.

### *Net income (loss)*

<b>(in thousands)</b>	<b>Six months ended June 30,</b>		<b>Period-to-period change</b>	
	<b>2016</b>	<b>2017</b>	<b>\$</b>	<b>%</b>
Net income (loss)	\$ 3,953	\$ (9,434)	\$ (13,387)	NM

Net income decreased by \$13.4 million resulting in a net loss of \$9.4 million for the six months ended June 30, 2017, as compared to net income of \$4.0 million for the six months ended June 30, 2016. This decrease in net income was primarily attributable to increased stock-based compensation expense of \$13.9 million and increased cost of revenue which related to higher employee related costs and royalty share payments to our partners for the six months ended June 30, 2017. Operating expenses increased primarily due to annual employee cost adjustments and increased headcount as a result of acquisitions in 2016. These increased costs are partially offset by increased revenue in the Software segment.

## **Years ended December 31, 2015 and 2016**

### **Revenue**

Total revenue increased by \$19.1 million, or 6%, for the year ended December 31, 2016 as compared to the year ended December 31, 2015. This increase was primarily attributable to an increase in software revenue of \$18.3 million, or 9%, for the same period, partially offset by a decrease in software related services revenue of \$1.5 million, or 4%. Our CES revenue also increased by \$2.6 million, or 6% for the year ended December 31, 2016 as compared to the corresponding prior year.

[Table of Contents](#)*Software segment*Software

<b>(dollars in thousands)</b>	<b>Year ended December 31,</b>		<b>Period-to-period change</b>	
	<b>2015</b>	<b>2016</b>	<b>\$</b>	<b>%</b>
Software revenue	\$205,567	\$223,818	\$ 18,251	9%
As a percent of software segment revenue	85%	86%		
As a percent of consolidated revenue	70%	71%		

The 9% increase in our software revenue for the year ended December 31, 2016 as compared to the year ended December 31, 2015, was primarily the result of an expansion in the number of units licensed by our existing customers under renewed software license agreements and, to a lesser extent, licensing of units to new customers pursuant to new software license agreements. This increase in software revenue occurred across the Americas, EMEA and APAC.

Software related services

<b>(dollars in thousands)</b>	<b>Year ended December 31,</b>		<b>Period-to-period change</b>	
	<b>2015</b>	<b>2016</b>	<b>\$</b>	<b>%</b>
Software related services revenue	\$37,294	\$35,770	\$ (1,524)	(4%)
As a percent of software segment revenue	15%	14%		
As a percent of consolidated revenue	13%	11%		

The 4% decrease in our software related services revenue for the year ended December 31, 2016 as compared to the year ended December 31, 2015, was primarily the result of our continued focus on higher-value projects aligned with our software.

Client engineering services

<b>(dollars in thousands)</b>	<b>Year ended December 31,</b>		<b>Period-to-period change</b>	
	<b>2015</b>	<b>2016</b>	<b>\$</b>	<b>%</b>
Client engineering services revenue	\$45,075	\$47,702	\$ 2,627	6%
As a percent of consolidated revenue	15%	15%		

The 6% increase in our CES revenue for the year ended December 31, 2016 as compared to the year ended December 31, 2015, was primarily due to an increase in demand for our consulting services and corresponding higher billable headcount placements during the period. Our headcount in the CES business increased 4% in 2016 as compared to the prior year.

Other

<b>(dollars in thousands)</b>	<b>Year ended December 31,</b>		<b>Period-to-period change</b>	
	<b>2015</b>	<b>2016</b>	<b>\$</b>	<b>%</b>
Other revenue	\$6,193	\$5,950	\$ (243)	(4%)
As a percent of consolidated revenue	2%	2%		

[Table of Contents](#)

Other revenue for the year ended December 31, 2015 included \$2.0 million of revenue related to royalties from our licensing of intellectual property technology that did not reoccur in the year ended December 31, 2016. Excluding the impact of these royalties, our Other revenue increased 42% for the year ended December 31, 2016 as compared to the prior year. This increase in our Other revenue was primarily due to an increase in demand for LED lighting and increased royalties received from licensing our technology to third party manufacturers and resellers.

**Cost of revenue***Software segment*Software

<b>(dollars in thousands)</b>	<b>Year ended December 31,</b>		<b>Period-to-period change</b>	
	<b>2015</b>	<b>2016</b>	<b>\$</b>	<b>%</b>
Cost of software revenue	\$27,406	\$31,962	\$ 4,556	17%
As a percent of software revenue	13%	14%		
As a percent of consolidated revenue	9%	10%		

Cost of software revenue increased by \$4.6 million, or 17%, for the year ended December 31, 2016 as compared to the year ended December 31, 2015, primarily attributable to a \$3.3 million increase in employee compensation costs, including stock-based compensation expense of \$0.3 million and increased third party royalty costs for software programs we include in our APA program of \$0.7 million.

Software related services

<b>(dollars in thousands)</b>	<b>Year ended December 31,</b>		<b>Period-to-period change</b>	
	<b>2015</b>	<b>2016</b>	<b>\$</b>	<b>%</b>
Cost of software related services revenue	\$30,079	\$27,653	\$ (2,426)	(8%)
As a percent of software related services revenue	81%	77%		
As a percent of consolidated revenue	10%	9%		

Cost of software related services revenue decreased by \$2.4 million, or 8%, for the year ended December 31, 2016 as compared to the year ended December 31, 2015, primarily related to a reorganization of personnel and the corresponding decrease in software related services revenue and our continued focus on higher-value projects aligned with our software.

Client engineering services segment

<b>(dollars in thousands)</b>	<b>Year ended December 31,</b>		<b>Period-to-period change</b>	
	<b>2015</b>	<b>2016</b>	<b>\$</b>	<b>%</b>
Cost of client engineering services revenue	\$36,081	\$38,106	\$ 2,025	6%
As a percent of client engineering services segment revenue	80%	80%		
As a percent of consolidated revenue	12%	12%		

Cost of CES revenue increased by \$2.0 million, or 6%, for the year ended December 31, 2016 as compared to the year ended December 31, 2015. This increase is primarily due to compensation expenses associated with a larger number of placements to meet customer demand.

[Table of Contents](#)*Other*

<b>(dollars in thousands)</b>	<b>Year ended December 31,</b>		<b>Period-to-period change</b>	
	<b>2015</b>	<b>2016</b>	<b>\$</b>	<b>%</b>
Cost of other revenue	\$5,642	\$4,879	\$ (763)	(14%)
As a percent of other revenue	91%	82%		
As a percent of consolidated revenue	2%	2%		

Cost of Other revenue decreased by \$0.8 million, or 14%, for the year ended December 31, 2016 as compared to the year ended December 31, 2015. This decrease is primarily due to our introduction of new products that have a lower cost of manufacturing.

**Gross profit**

<b>(dollars in thousands)</b>	<b>Year ended December 31,</b>		<b>Period-to-period change</b>	
	<b>2015</b>	<b>2016</b>	<b>\$</b>	<b>%</b>
Gross profit	\$194,921	\$210,640	\$ 15,719	8%
As a percent of consolidated revenue	66%	67%		

Gross profit increased by \$15.7 million, or 8%, for the year ended December 31, 2016 as compared to the year ended December 31, 2015. This increase in gross profit was primarily attributable to the growth of our software revenue of \$18.3 million driven by the expansion in the number of units purchased by our existing customers and, to a lesser extent, sales to new customers. Gross profit margin increased to 67% in the year ended December 31, 2016 from 66% in the year ended December 31, 2015.

**Operating expenses**

Operating expenses, as discussed below, support all of the products and services that we provide to our customers and, as a result, they are reported and discussed here in an aggregate total.

*Research and development*

<b>(dollars in thousands)</b>	<b>Year ended December 31,</b>		<b>Period-to-period change</b>	
	<b>2015</b>	<b>2016</b>	<b>\$</b>	<b>%</b>
Research and development	\$62,777	\$71,325	\$ 8,548	14%
As a percent of consolidated revenue	21%	23%		

Research and development expenses increased by \$8.5 million, or 14%, for the year ended December 31, 2016 as compared to the year ended December 31, 2015. This increase is attributable to an increase in employee costs of \$6.2 million resulting from an increase in our headcount in 2016, primarily due to acquisitions and annual compensation adjustments. In addition, the share-based compensation expense component of our research and development expense increased during the year ended December 31, 2016 by \$1.2 million as compared to the corresponding prior year primarily due to the increased value of our shares of common stock. Excluding the impact of stock-based compensation, research and development costs increased by 12% from \$62.6 million to \$70.0 million for the years ended December 31, 2015 and 2016, respectively.

[Table of Contents](#)*Sales and marketing*

<b>(dollars in thousands)</b>	<b>Year ended December 31,</b>		<b>Period-to-period change</b>	
	<b>2015</b>	<b>2016</b>	<b>\$</b>	<b>%</b>
Sales and marketing	\$63,080	\$66,086	\$ 3,006	5%
As a percent of consolidated revenue	21%	21%		

Sales and marketing expenses increased by \$3.0 million, or 5%, for the year ended December 31, 2016, as compared to the year ended December 31, 2015. This increase is primarily attributable to a \$2.4 million increase in employee compensation costs, including stock-based compensation and a \$0.7 million increase in our sales and marketing campaigns to support our direct sales force.

*General and administrative*

<b>(dollars in thousands)</b>	<b>Year ended December 31,</b>		<b>Period-to-period change</b>	
	<b>2015</b>	<b>2016</b>	<b>\$</b>	<b>%</b>
General and administrative	\$54,069	\$57,202	\$ 3,133	6%
As a percent of consolidated revenue	18%	18%		

General and administrative expenses increased by \$3.1 million, or 6%, for the year ended December 31, 2016 as compared to the year ended December 31, 2015. This increase is primarily attributable to a \$2.7 million increase in share-based compensation expense. These expenses were partially offset by decreases in professional services expenses primarily related to a decline in legal costs for outstanding legal matters. Excluding the impact of stock-based compensation, general and administrative expenses increased by 1%, from \$53.8 million to \$54.2 million for the years ended December 31, 2015 and 2016, respectively.

*Amortization of intangible assets*

<b>(dollars in thousands)</b>	<b>Year ended December 31,</b>		<b>Period-to-period change</b>	
	<b>2015</b>	<b>2016</b>	<b>\$</b>	<b>%</b>
Amortization of intangible assets	\$2,624	\$3,322	\$ 698	27%
As a percent of consolidated revenue	1%	1%		

Amortization of intangible assets increased by \$0.7 million, or 27%, for the year ended December 31, 2016 as compared to the year ended December 31, 2015. This increase was attributable to the amortization of intangible assets associated with acquisitions completed during the year ended December 31, 2016 and a full year of amortization related to acquisitions completed during the year ended December 31, 2015.

*Other operating income*

<b>(dollars in thousands)</b>	<b>Year ended December 31,</b>		<b>Period-to-period change</b>	
	<b>2015</b>	<b>2016</b>	<b>\$</b>	<b>%</b>
Other operating income	\$(2,576)	\$(2,742)	\$ (166)	(6)%
As a percent of consolidated revenue	(1)%	(1)%		

Other operating income increased by \$0.2 million, or 6%, for the year ended December 31, 2016 as compared to the year ended December 31, 2015. This increase was primarily attributable to an increase in government

[Table of Contents](#)

subsidies, primarily in France, in the form of grant income associated with certain of our research and development activities.

*Interest expense*

<b>(dollars in thousands)</b>	<b>Year ended December 31,</b>		<b>Period-to-period change</b>	
	<b>2015</b>	<b>2016</b>	<b>\$</b>	<b>%</b>
Interest expense	\$2,416	\$2,265	\$ (151)	(6%)
As a percent of consolidated revenue	1%	1%		

Interest expense decreased by \$0.2 million, or 6%, for the year ended December 31, 2016 as compared to the year ended December 31, 2015. This decrease was due to a reduction in our interest expense related to our Credit Agreement as a result of a partial debt repayment and the use of lower cost short-term borrowing contracts related to our line of credit borrowings.

*Other expense (income), net*

<b>(dollars in thousands)</b>	<b>Year ended December 31,</b>		<b>Period-to-period change</b>	
	<b>2015</b>	<b>2016</b>	<b>\$</b>	<b>%</b>
Other expense (income), net	\$ 782	\$ (520)	\$ (1,302)	NM
As a percent of consolidated revenue	—%	—%		

Other expense (income), net decreased by \$1.3 million for the year ended December 31, 2016 as compared to the year ended December 31, 2015. This decrease was due to fluctuations in the United States dollar relative to other functional currencies during the year ended December 31, 2016 compared to the prior year.

*Income tax expense*

<b>(dollars in thousands)</b>	<b>Year ended December 31,</b>		<b>Period-to-period change</b>	
	<b>2015</b>	<b>2016</b>	<b>\$</b>	<b>%</b>
Income tax expense	\$818	\$ 3,539	\$ 2,721	333%

Income tax expense increased by \$2.7 million for the year ended December 31, 2016 as compared to the year ended December 31, 2015. This increase is primarily due to a \$1.8 million increase in tax expense related to nondeductible stock-based compensation, a \$0.8 million increase in the expense related to an increase in pre-tax income related to foreign operations, partially offset by certain tax deductions and credits and foreign income taxes at rates other than the federal statutory rates. See Note 13 in the notes to consolidated financial statements included elsewhere in this prospectus.

*Net income (loss)*

<b>(dollars in thousands)</b>	<b>Year ended December 31,</b>		<b>Period-to-period change</b>	
	<b>2015</b>	<b>2016</b>	<b>\$</b>	<b>%</b>
Net income (loss)	\$ 10,931	\$ 10,163	\$ 768	(7%)

Net income (loss) decreased by \$0.8 million, or 7%, for the year ended December 31, 2016, as compared to the year ended December 31, 2015. This decrease in Net income (loss) was primarily attributable to increased stock-

## [Table of Contents](#)

based compensation expense of \$4.5 million and increased cost of revenue which related to higher employee related costs and royalty share payments to our partners for the year ended December 31, 2016. Operating expenses increased primarily due to annual employee cost adjustments and for those employees who joined us in connection with acquisitions in 2016 and a full year of compensation expense related to those employees who joined in connection with acquisitions completed in 2015. These increased costs are mostly offset by increased revenue in all segments with the largest increase in the Software segment.

### Key metrics

We monitor the following key non-GAAP financial and operating metrics to help us evaluate our business, measure our performance, identify trends affecting our business, formulate business plans and make strategic decisions. In addition to our results determined in accordance with GAAP, we believe the following non-GAAP financial and operating metrics are useful in evaluating our operating performance.

**Billings.** Billings consists of our total revenue plus the change in our deferred revenue in a given period. As we generally bill our customers at the time of sale, but typically recognize a majority of the related revenue ratably over time, management believes that Billings is a meaningful way to measure and monitor our ability to provide our business with the working capital generated by upfront payments from our customers. While we believe that billings provides valuable insight into the cash that will be generated from sales of our software and services, this metric may vary from period-to-period for a number of reasons including the impact of changes in foreign currency exchange rates and the potential impact of acquisitions. See the section entitled “Selected historical consolidated financial and other data—Reconciliation of non-GAAP financial measures” for information regarding the limitations of using Billings as a financial measure and for a reconciliation of Billings to revenue, the most directly comparable financial measure calculated in accordance with GAAP.

Our Billings were as follows:

(dollars in thousands)	Year ended December 31,		Period-to-period change	Six months ended June 30,		Period-to-period change
	2015	2016	%	2016	2017	%
Billings	\$297,358	\$320,653	8%	\$165,449	\$181,379	10%

Billings increased by \$15.9 million, or 10%, for the six months ended June 30, 2017, as compared to the six months ended June 30, 2016. This increase in Billings was attributable to a 10% increase in Software segment billings.

Billings increased by \$23.3 million, or 8%, for the year ended December 31, 2016 as compared to the year ended December 31, 2015. This increase in Billings was primarily attributable to an 8% increase in Software segment billings equaling \$22.5 million, with the remaining increase in the CES segment and our other businesses.

**Adjusted EBITDA.** We define Adjusted EBITDA as net income (loss) adjusted for income tax expense (benefit), interest expense, interest income and other, depreciation and amortization, stock-based compensation expense, restructuring charges, asset impairment charges and other special items as determined by management. We believe that Adjusted EBITDA is a meaningful measure of performance as it is commonly utilized by us and the investment community to analyze operating performance in our industry. See the section entitled “Selected historical consolidated financial and other data—Reconciliation of non-GAAP financial measures” for information regarding the limitations of using Adjusted EBITDA as a financial measure and for a reconciliation of Adjusted EBITDA to net income (loss), the most directly comparable financial measure calculated in accordance with GAAP.

## [Table of Contents](#)

Our Adjusted EBITDA was as follows:

(dollars in thousands)	Year ended		Period-to-period change	Six months ended		Period-to-period change
	December 31,			June 30,		
	2015	2016	%	2016	2017	%
Adjusted EBITDA	\$22,949	\$30,830	34%	\$ 12,933	\$ 7,056	(45%)

Adjusted EBITDA decreased by \$5.9 million, or 45%, for the six months ended June 30, 2017, as compared to the six months ended June 30, 2016. This decrease in Adjusted EBITDA was primarily attributable to the Software segment. The increase in revenue was offset by the increase in cost of revenue which related to higher employee related costs and royalty payments to our partners for the six months ended June 30, 2017. The increase in operating expenses was primarily related to annual employee cost adjustments and increased headcount as a result of acquisitions in 2016.

Adjusted EBITDA increased by \$7.9 million, or 34%, for the year ended December 31, 2016 as compared to the year ended December 31, 2015. This increase in Adjusted EBITDA was primarily attributable to increases in all segments with the largest increase in the Software segment. The increase in revenue more than offset the increase in cost of revenue which related to higher employee related costs and royalty share payments to our partners for the year ended December 31, 2016. The increase in operating expenses was primarily related to annual employee cost adjustments and for those employees who joined us in connection with acquisitions in 2016 and a full year of compensation expense related to those employees who joined us in connection with acquisitions completed in 2015.

**Free Cash Flow.** Free Cash Flow is a non-GAAP financial measure that we calculate as cash flow provided by operating activities less capital expenditures. We believe that Free Cash Flow is useful in analyzing our ability to service and repay debt and return value directly to stockholders. See the section entitled "Selected historical consolidated financial and other data—Reconciliation of non-GAAP financial measures" for information regarding the limitations of using Free Cash Flow as a financial measure and for a reconciliation of Free Cash Flow to net cash provided by operating activities, the most directly comparable financial measure calculated in accordance with GAAP.

Our Free Cash Flow was as follows:

(dollars in thousands)	Year ended		Period-to-period change	Six months ended		Period-to-period change
	December 31,			June 30,		
	2015	2016	%	2016	2017	%
Net cash provided by operating activities	\$10,838	\$21,385	97%	\$ 22,006	\$ 26,117	19%
Free Cash Flow	\$ 5,605	\$11,941	113%	\$ 18,307	\$ 21,782	19%

Free Cash Flow increased by \$3.5 million, or 19%, for the six months ended June 30, 2017 as compared to the six months ended June 30, 2016. This increase in Free Cash Flow was attributable to an increase in net cash from operating activities of \$4.1 million, partially offset by an increase of \$0.6 million in capital expenditures.

Free Cash Flow increased by \$6.3 million, or 113%, for the year ended December 31, 2016 as compared to the year ended December 31, 2015. This increase in Free Cash Flow was primarily attributable to the increase in net cash from operating activities of \$10.5 million, which was partially offset by an increase of \$4.2 million in capital expenditures. Net cash from operating activities increased primarily due to higher net income, adjusted for non-cash items and changes in working capital. The capital expenditures increase included a \$4.0 million capital expenditure for the purchase of land adjacent to our corporate headquarters. Excluding this land



[Table of Contents](#)

purchase, our capital expenditures were consistent with the prior year and our Free Cash Flow would have increased by \$10.3 million.

**Recurring Software License Rate.** A key factor to our success is our recurring software license rate which we measure through billings, primarily derived from annual renewals of our existing subscription customer agreements. We calculate our recurring software license rate for a particular period by dividing (i) the sum of software term-based license billings, software license maintenance billings, and 20% of software perpetual license billings which we believe approximates maintenance as an element of the arrangement by (ii) the total software license billings including all term-based, maintenance, and perpetual license billings from all customers for that period. For the years ended December 31, 2015, 2016 and six months ended June 30, 2017, our recurring software license rate was 88%, 90% and 91%, respectively.

### Quarterly results of operations

The following tables set forth selected unaudited quarterly consolidated statements of operations data for each of the six quarters in the period ended June 30, 2017, as well as the percentage of revenues that each line item represents for each quarter. The information for each of these quarters has been prepared on the same basis as the audited annual consolidated financial statements included elsewhere in this prospectus and, in the opinion of management, includes all adjustments, which consist only of normal recurring adjustments, necessary for the fair presentation of the results of operations for these periods in accordance with GAAP. This data should be read in conjunction with our audited and unaudited consolidated financial statements and related notes included elsewhere in this prospectus. These quarterly operating results are not necessarily indicative of our operating results for a full year or any future period. The quarterly results for the three months ended September 30, 2016 and December 31, 2016 have not been reviewed by the Company's Independent Registered Public Accounting Firm.

(in thousands)	Three months ended					
	March 31, 2016	June 30, 2016	Sept. 30, 2016	Dec. 31, 2016	March 31, 2017	June 30, 2017
<b>Revenue:</b>						
Software	\$ 52,132	\$ 54,797	\$ 55,804	\$ 61,085	\$ 54,097	\$ 59,600
Software related services	9,134	8,656	8,676	9,304	8,971	8,204
Total software	61,266	63,453	64,480	70,389	63,068	67,804
Client engineering services	11,946	12,343	12,146	11,267	12,229	12,365
Other	1,617	1,715	1,426	1,192	1,585	1,477
Total revenue	74,829	77,511	78,052	82,848	76,882	81,646
<b>Cost of revenue:</b>						
Software	7,381	7,640	8,479	8,462	8,904	8,729
Software related services	6,958	6,880	6,527	7,288	6,659	7,114
Total software	14,339	14,520	15,006	15,750	15,563	15,843
Client engineering services	9,720	9,487	9,579	9,320	10,141	9,828
Other	1,359	1,333	1,036	1,151	1,050	1,247
Total cost of revenue	25,418	25,340	25,621	26,221	26,754	26,918
Gross profit	49,411	52,171	52,431	56,627	50,128	54,728
<b>Operating expenses:</b>						
Research and development	16,111	17,901	19,401	17,912	18,770	22,838
Sales and marketing	15,601	16,492	16,961	17,032	16,910	19,428

[Table of Contents](#)

(in thousands)	Three months ended					
	March 31, 2016	June 30, 2016	Sept. 30, 2016	Dec. 31, 2016	March 31, 2017	June 30, 2017
General and administrative	13,737	14,145	15,793	13,527	16,089	21,201
Amortization of intangible assets	657	820	875	970	943	1,155
Other operating income	(327)	(802)	(823)	(790)	(594)	(2,736)
Total operating expenses	45,779	48,556	52,207	48,651	52,118	61,886
Operating income (loss)	3,632	3,615	224	7,976	(1,990)	(7,158)
Interest expense	690	557	507	511	611	548
Other expense (income), net	(260)	(392)	148	(16)	359	427
Income (loss) before income taxes	3,202	3,450	(431)	7,481	(2,960)	(8,133)
Income tax expense (benefit)	1,721	978	(745)	1,585	(772)	(887)
Net income (loss)	\$ 1,481	\$ 2,472	\$ 314	\$ 5,896	\$ (2,188)	\$ (7,246)

[Table of Contents](#)

The following table sets forth the components of our unaudited quarterly consolidated statements of operations for each of the periods presented as a percentage of revenue:

(as a percentage of total revenue)	Three months ended					
	March 31, 2016	June 30, 2016	Sept. 30, 2016	Dec. 31, 2016	March 31, 2017	June 30, 2017
<b>Revenue:</b>						
Software	70%	71%	72%	74%	70%	73%
Software related services	12	11	11	11	12	10
Total software	82	82	83	85	82	83
Client engineering services	16	16	15	14	16	15
Other	2	2	2	1	2	2
Total revenue	100	100	100	100	100	100
<b>Cost of revenue:</b>						
Software	10	10	11	10	11	11
Software related services	9	9	8	9	9	8
Total software	19	19	19	19	20	19
Client engineering services	13	12	12	11	13	12
Other	2	2	2	2	2	2
Total cost of revenue	34	33	33	32	35	33
Gross profit	66	67	67	68	65	67
<b>Operating expenses:</b>						
Research and development	21	23	25	22	24	28
Sales and marketing	21	21	22	20	22	24
General and administrative	18	18	20	16	21	26
Amortization of intangible assets	1	1	1	1	1	1
Other operating income	—	(1)	(1)	(1)	—	(3)
Total operating expenses	61	62	67	58	68	76
Operating income (loss)	5	5	—	10	(3)	(9)
Interest expense	1	1	1	1	1	1
Other expense (income), net	—	—	—	—	—	—
Income (loss) before income taxes	4	4	(1)	9	(4)	(10)
Income tax expense (benefit)	2	1	(1)	2	(1)	(1)
Net income (loss)	2%	3%	—%	7%	(3)%	(9)%

[Table of Contents](#)

The following tables provide reconciliations of revenue to Billings and net income (loss) to Adjusted EBITDA, for each of the periods presented:

**Billings**

(in thousands)	Three months ended					
	March 31, 2016	June 30, 2016	Sept. 30, 2016	Dec. 31, 2016	March 31, 2017	June 30, 2017
Revenue	\$ 74,829	\$ 77,511	\$ 78,052	\$ 82,848	\$ 76,882	\$ 81,646
Ending deferred revenue	123,525	119,625	114,417	113,929	132,466	136,780
Beginning deferred revenue	(106,516)	(123,525)	(119,625)	(114,417)	(113,929)	(132,466)
Billings	\$ 91,838	\$ 73,611	\$ 72,844	\$ 82,360	\$ 95,419	\$ 85,960

**Adjusted EBITDA**

(in thousands)	Three months ended					
	March 31, 2016	June 30, 2016	Sept. 30, 2016	Dec. 31, 2016	March 31, 2017	June 30, 2017
Net income (loss)	\$ 1,481	\$ 2,472	\$ 314	\$ 5,896	\$ (2,188)	\$ (7,246)
Income tax expense (benefit)	1,721	978	(745)	1,585	(772)	(887)
Stock-based compensation expense	59	116	4,875	82	2,869	11,168
Interest expense	690	557	507	511	611	548
Interest income and other <sup>(1)</sup>	37	(25)	(93)	(168)	(85)	(2,046)
Depreciation and amortization	2,272	2,575	2,453	2,680	2,474	2,610
Adjusted EBITDA	\$ 6,260	\$ 6,673	\$ 7,311	\$ 10,586	\$ 2,909	\$ 4,147

(1) Includes a non-recurring adjustment for a change in estimated legal expenses resulting in \$2 million of income for the three months ended June 30, 2017.

**Quarterly trends**

The increase in total revenues in each of the periods presented was primarily due to an increase in the number of customers, an increase in the number of units added by existing customers, increases in price, and an increase in the number of products purchased by existing customers. Total revenue tends to increase each quarter within the calendar year due to timing of customer renewals.

Cost of revenues in each of the periods presented increased on an incremental basis to support the demand for our products and services. The improvement in gross margin, when compared to the corresponding prior year quarter, was primarily the result of the increased revenue within the Software segment which has historically higher margins.

Sales and marketing expenses have consistently increased for each of the periods presented due to the expansion in headcount and an increased focus on marketing. Sales and marketing expenses have also increased in most quarters as a result of stock-based compensation expenses, most notably in the two most recent quarters.

Research and development expenses increased steadily during 2015, 2016, and the first half of 2017 due to growth in headcount, including headcount from acquired companies, and annual employee cost adjustments. Research and development expenses have increased in most quarters as a result of stock-based compensation expenses, most notably in the two most recent quarters.

## [Table of Contents](#)

General and administrative expenses have increased during the quarterly periods primarily due to increases in our headcount and annual employee cost adjustments. General and administrative expenses have increased in most quarters as a result of stock-based compensation expenses, most notably in the two most recent quarters.

Amortization of intangible assets has trended up during quarterly periods due to amortization associated with acquisitions made in the past two years.

### **Liquidity and capital resources**

Our principal sources of liquidity have been the net payments received from global customers using our software and services as well as our periodic draws on our credit facilities. We believe that funds generated from operations, with cash and cash equivalents and the amounts available to us to borrow under our credit facility will be sufficient to meet our anticipated cash needs for at least the next 12 months.

#### ***Credit facility***

As of December 31, 2015, our credit facility, the 2013 Credit Agreement, consisted of a \$67.1 million term loan, a \$20.0 million revolving commitment and a \$1.0 million ancillary facility. We were required to make quarterly principal payments on our term loan and any outstanding balance was to be paid in full on the maturity date of December 18, 2018.

On April 18, 2016, we entered into an amended and restated credit agreement, the 2016 Credit Agreement, with JPMorgan Chase Bank, N.A., as administrative agent, which restated the 2013 Credit Agreement in its entirety. The 2016 Credit Agreement originally consisted of a \$65.0 million term loan, or Term Loan A, and a \$35.0 million revolving commitment, or the Revolving Credit Facility. In October 2016, the 2016 Credit Agreement was amended to facilitate our purchase of certain real property adjacent to our corporate headquarters. In November 2016, the 2016 Credit Agreement was further amended pursuant to which the Royal Bank of Canada became a lender thereunder and the commitment under the Revolving Credit Facility was increased to \$60.0 million. Included in the Revolving Credit Facility are a \$5.0 million swingline subfacility, provisions for an additional \$4.0 million ancillary facility, and a letter of credit subfacility. As of June 30, 2017 and December 31, 2016, respectively, we had \$52.5 million and \$57.5 million outstanding on Term Loan A and \$18.0 million and \$27.4 million outstanding on our Revolving Credit Facility.

On June 14, 2017, we entered into a second amended and restated credit agreement with JPMorgan Chase Bank, N.A., as administrative agent, which restated the 2016 Credit Agreement, as amended, in its entirety, the 2017 Credit Agreement or, along with the 2016 Credit Agreement, as the context so requires, and as amended from time to time, the Credit Agreement. This amendment was administrative in nature and did not change amounts, terms, or rates. On September 28, 2017, the Credit Agreement was amended to facilitate our acquisition of Runtime.

The Credit Agreement contains a number of covenants that, among other things, restrict, subject to certain exceptions, our ability to incur additional indebtedness; create liens on assets; make investments, loans, advances or acquisitions; pay dividends or other distributions; redeem or repurchase certain equity interests; guarantee the obligations of others; and change the business conducted by us. In addition, the Credit Agreement contains financial covenants relating to minimum liquidity of \$20.0 million, maintaining a minimum debt service coverage ratio of 1.3 to 1.0 and maximum leverage ratio of 3.0 to 1.0, as defined in the Credit Agreement. At June 30, 2017 and December 31, 2016, we were in compliance with all financial covenants. For additional information about the Credit Agreement, see Note 7 in the notes to consolidated financial statements included elsewhere in this prospectus.

We intend to use the net proceeds of this offering to repay our term loan, which has an outstanding balance of \$52.5 million as of June 30, 2017, and to pay off the revolving credit balance under our credit facility as set forth

## [Table of Contents](#)

in the Credit Agreement. As of June 30, 2017, the principal amount of the revolving loans outstanding was \$18.0 million. We anticipate entering into a new revolving credit facility, or New Credit Facility, upon the closing of this offering and intend to use the net proceeds of this offering to pay the related origination fees and expenses.

### ***New revolving credit facility***

Upon the closing of this offering, we anticipate entering into a credit agreement for the New Credit Facility with Altair Engineering Inc., as borrower, JPMorgan Chase Bank, N.A., as the lead arranger, sole book runner, the administrative agent, swingline lender and letter of credit issuer, and a syndicate of lenders. We expect that the New Credit Facility will provide for an initial aggregate commitment amount of \$100 million on the closing date of the New Credit Facility, with a sublimit for the issuance of letters of credit of up to \$5 million and a sublimit for swingline loans, which sublimits will be available, in each case, as long as the aggregate exposures of the lenders do not exceed the aggregate commitments and are subject to the satisfaction of certain conditions. The New Credit Facility will mature five years following the closing date of the New Credit Facility. We expect that the New Credit Facility will be available (i) to finance working capital needs, (ii) for general corporate purposes of the Company including permitted acquisitions, (iii) to refinance certain existing indebtedness, and (iv) to pay fees and expenses related to the New Credit Facility.

We expect that the New Credit Facility will allow us to request that the aggregate commitments under the New Credit Facility be increased to up to \$150 million, subject to certain conditions, by obtaining additional commitments from the existing lenders or by causing a person acceptable to the administrative agent to become a lender (in each case subject to the terms and conditions set forth in the New Credit Facility).

We expect that all borrowings and letter of credit issuances under the New Credit Facility will be subject to the satisfaction of certain customary conditions, including the absence of any default or event of default and the accuracy of representations and warranties.

We expect that borrowings under the New Credit Facility will bear interest at a rate per annum equal to an agreed upon applicable margin plus, at our option, either the Alternate Base Rate (defined as the greatest of (1) the Prime Rate (as defined in the New Credit Facility) in effect on such day, (2) the Federal Funds Effective Rate (as defined in the New Credit Facility) in effect on such day plus 1/2 of 1.00% or (3) the Adjusted LIBO Rate (as defined in the New Credit Facility) for a one month interest period on such day (or if such day is not a business day, the immediately preceding business day) plus 1.00%) or the Adjusted LIBO Rate. We expect that the applicable margin for borrowings under the New Credit Facility will be based on our most recently tested consolidated total net leverage ratio and will vary from (a) in the case of Eurodollar loans, 1.25% to 2.00%, and (b) in the case of ABR loans or swingline loans, 0.25% to 1.00%. We expect that the unused portion of the New Credit Facility will be subject to a commitment fee ranging from 0.15% to 0.30%. We will also pay certain ongoing customary fees and expenses under the New Credit Facility. We expect that the interest rate amount under the New Credit Facility must at no point exceed the highest lawful rate. We expect that with respect to the issuance of letters of credit, we will pay (i) to the lenders, a participation fee with respect to each such lender's participations in letters of credit, (ii) to the issuing bank, an issuing fee of 0.25% of the amount of the letters of credit issued by such issuing bank, and (iii) other customary fees owed to the issuing bank.

We expect that the New Credit Facility will be secured by collateral including (i) substantially all of our properties and assets, and the properties and assets of our domestic subsidiaries but excluding any patents, copyrights, patent applications or copyright applications or any trade secrets or software products and (ii) pledges of the equity interests in all present and future domestic subsidiaries (subject to certain exceptions as provided for under the New Credit Facility). We expect that our direct and indirect domestic subsidiaries will guaranty all of the obligations under the New Credit Facility.

## [Table of Contents](#)

We expect that the New Credit Facility will provide for customary representations, warranties and covenants, including, among other things, covenants relating to financial and collateral reporting, notices of material events, maintenance of the existence of the business and material rights and privileges, compliance with laws and material obligations, our ability to enter into certain hedging agreements, limitations on our ability to sell or acquire assets or make other acquisitions and limitations on indebtedness and liens, dividends and distributions, transactions with affiliates, loans and advances, sale and leaseback transactions, optional payments and modifications of debt, changes in fiscal year, amendment of material documents and certain fundamental transactions.

We expect that the New Credit Facility will also require us to maintain the following financial covenants:

- *Maximum Net Leverage Ratio*: Commencing with the fiscal quarter ending December 31, 2017 and on the last day of each fiscal quarter thereafter, the Company on a consolidated basis will not permit the ratio of total indebtedness (net of unrestricted domestic cash in excess of \$20,000,000) to EBITDA, as such terms are defined in the New Credit Facility, for the rolling four quarter period ending on such date to be greater than 3.00 to 1.00 as of the last day of each fiscal quarter.
- *Consolidated Interest Coverage Ratio*: Commencing with the fiscal quarter ending December 31, 2017 and on the last day of each fiscal quarter thereafter, the Company on a consolidated basis will not permit the ratio of (x) EBITDA to (y) cash Consolidated Interest Expense, as such terms are defined in the New Credit Facility, in each case for the rolling four quarter period ending on such date, to be less than 3.00 to 1.00 as of the last day of each fiscal quarter.

We also expect that the New Credit Facility will contain events of default customary for facilities of this nature, including, but not limited, to (i) non-payment of principal, interest, fees or other amounts due under the New Credit Facility, (ii) representations and warranties are incorrect in any material respect, (iii) events of default resulting from our failure or the failure of any credit party to comply with covenants and financial ratios, (iv) the occurrence of a change of control, (v) the institution of insolvency or similar proceedings against us or any credit party, (v) material judgments, (vi) certain ERISA events, and (vii) the occurrence of a default under any other material indebtedness. Upon the occurrence and during the continuation of an event of default, subject to the terms and conditions of our New Credit Facility, we expect that the lenders will be able to declare any outstanding principal balance of our New Credit Facility, together with accrued and unpaid interest, to be immediately due and payable, terminate the commitment thereunder and exercise other remedies.

### **Cash flows**

As of June 30, 2017, and December 31, 2016, respectively, we had an aggregate of cash and cash equivalents of \$17.4 million and \$16.9 million, which we held for working capital purposes and capital expenditures. As of June 30, 2017, and December 31, 2016, respectively, \$0.1 million and \$1.6 million of this aggregate amount was held in the United States and \$15.5 million and \$14.2 million was held in the APAC and EMEA regions with the remainder held in Canada, Mexico, and South America.

There are no significant restrictions on the ability of our subsidiaries to pay dividends or make other distributions to Altair. Based on our current liquidity needs and repatriation strategies, we expect that we can manage our global liquidity needs without material adverse cash tax implications.

## [Table of Contents](#)

The following table summarizes our cash flows for the periods indicated:

(in thousands)	Year ended December 31,		Six months ended June 30,	
	2015	2016	2016	2017
Net cash provided by operating activities	\$10,838	\$ 21,385	\$22,006	\$ 26,117
Net cash used in investing activities	(8,030)	(16,033)	(8,537)	(10,920)
Net cash used in financing activities	(4,697)	(1,864)	(6,675)	(15,609)
Effect of exchange rate changes on cash, cash equivalents and restricted cash	(1,639)	(362)	646	962
Net (decrease) increase in cash, cash equivalents and restricted cash	\$ (3,528)	\$ 3,126	\$ 7,440	\$ 550

### *Net cash provided by operating activities*

Net cash provided by operating activities for the six months ended June 30, 2017 was \$26.1 million which reflects an increase of \$4.1 million compared to the six months ended June 30, 2016. This increase primarily reflects a \$7.3 million increase in deferred revenue along with net changes to our working capital position, for the six months ended June 30, 2017 as compared to the six months ended June 30, 2016.

Net cash provided by operating activities for the year ended December 31, 2016 was \$21.4 million which reflects an increase of \$10.5 million compared to the year ended December 31, 2015. This increase primarily reflects a \$4.5 million increase in non-cash stock-based compensation expense and a \$3.1 million improvement in deferred taxes along with net changes to our working capital position, as compared to the prior year.

### *Net cash used in investing activities*

Net cash used in investing activities for the six months ended June 30, 2017 was \$10.9 million which reflects an increase in cash used of \$2.4 million compared to the six months ended June 30, 2016. This increase was the result of an increase in cash payments for business acquisitions and capital expenditures in the six months ended June 30, 2017 as compared to the six months ended June 30, 2016.

Net cash used in investing activities for the year ended December 31, 2016 was \$16.0 million which reflects an increase in cash used of \$8.0 million compared to the year ended December 31, 2015. This reflects a \$4.0 million purchase of real property adjacent to our corporate headquarters. The remaining \$4.0 million primarily relates to increased use of cash for acquisitions.

### *Net cash used in financing activities*

Net cash used in financing activities for the six months ended June 30, 2017 was \$15.6 million which reflects an increase in cash used of \$8.9 million compared to the six months ended June 30, 2016. This reflects a \$9.6 million increase in net debt payments for the six months ended June 30, 2017 compared to the six months ended June 30, 2016.

Net cash used in financing activities for the year ended December 31, 2016 was \$1.9 million which reflects a decrease in cash used of \$2.8 million compared to the year ended December 31, 2015. This reflects a \$4.8 million decrease in net debt payments compared to the prior year partially offset by a \$1.3 million increase in redemptions of our common stock, and a \$0.7 million return of capital in the year ended December 31, 2016.

### *Effect of exchange rate changes on cash, cash equivalents and restricted cash*

The effect of exchange rate changes on cash, cash equivalents and restricted cash for the six months ended June 30, 2017 was not significantly different from the six months ended June 30, 2016.



## [Table of Contents](#)

The adverse effect of exchange rate changes on cash, cash equivalents and restricted cash for the year ended December 31, 2016 decreased by \$1.3 million as compared to the prior year due to the decreased effect from fluctuations in foreign currency exchange rates.

### Commitments and contractual obligations

Our principal commitments and contractual obligations at December 31, 2016 consisted of obligations under operating leases for our office facilities and other debt obligations. There have been no significant changes to commitments and contractual obligations as of June 30, 2017. As of December 31, 2016, the future non-cancelable minimum lease payments under these obligations, and our future non-cancelable minimum payments under our other contractual obligations, were as follows:

(in thousands)	Total	Payments due by period			
		Less than 1 year	1-3 years	3-5 years	More than 5 years
Long-term debt obligations (excluding interest)	\$ 85,185	\$10,304	\$74,881	\$ —	\$ —
Capital lease obligations	196	131	65	—	—
Post-retirement benefits	2,829	356	454	484	1,535
Operating lease obligations	18,531	7,362	8,110	3,038	21
Royalties	902	399	503	—	—
Related parties	1,164	1,045	119	—	—
Other long-term liabilities	6,888	3,307	3,081	500	—
Total	\$115,695	\$22,904	\$87,213	\$4,022	\$ 1,556

Contractual obligations identified in the table above do not include liabilities associated with uncertain tax positions due to the high degree of uncertainty regarding the future cash outflows associated with these amounts. For additional discussion of uncertain tax positions, see Note 13 in the notes to consolidated financial statements included elsewhere in this prospectus.

### Off-balance sheet arrangements

Through June 30, 2017, we did not have any relationships with unconsolidated organizations or financial partnerships, such as structured finance or special purpose entities that would have been established for the purpose of facilitating off-balance sheet arrangements or other contractually narrow or limited purposes.

### Critical accounting policies and estimates

Our management's discussion and analysis of our financial condition and results of operations is based on our financial statements, which have been prepared in accordance with GAAP. The preparation of these financial statements requires us to make estimates and assumptions that affect the reported amounts of assets and liabilities and the disclosure of contingent assets and liabilities at the date of the financial statements, as well as the reported revenues generated and expenses incurred during the reporting periods. Our estimates are based on our historical experience and on various other factors that we believe are reasonable under the circumstances, the results of which form the basis for making judgments about the carrying value of assets and liabilities that are not readily apparent from other sources. Actual results may differ from these estimates under different assumptions or conditions. We believe that the accounting policies discussed below are critical to understanding our historical and future performance, as these policies relate to the more significant areas involving management's judgments and estimates. For further discussion on our significant accounting policies, see Note 2 in the notes to the consolidated financial statements included elsewhere in this prospectus.

## **Revenue recognition**

We generate revenue from our Software and CES segments and our other businesses. Revenue is recognized when persuasive evidence of an agreement exists, delivery has occurred or services have been rendered, the fee is fixed or determinable, and collection of the fee is probable or reasonably assured.

### Software

Software revenue includes product revenue from software product licensing arrangements consisting of software and software maintenance and support in the form of post-contract customer support, or PCS.

Our software products are sold to customers primarily through our patented units-based subscription licensing model through a term-based software licensing and to a lesser degree, perpetual software licensing. This units-based subscription licensing model allows customers to license a pool of units for their organizations, providing individual users flexible access to our entire portfolio of software applications as well as to our growing portfolio of partner products. These arrangements are referred to as "unit" arrangements. Units are a fixed means of measuring usage. The amount of software usage is limited by the number of the units licensed by the customer. Revenue from these arrangements is fixed (based on the units licensed) and is not based on actual customer usage of each software product.

Software product license arrangements may include PCS and professional services, such as consulting, implementation services, training, and support, which represent multiple-element arrangements. We have analyzed the elements included in its multiple element arrangements and have determined that we do not have vendor-specific objective evidence, or VSOE of fair value to allocate revenue to our software products license, PCS, and professional services including consulting, implementation services, training and support. Revenue from the software products licenses, including perpetual licenses, PCS and professional services, if applicable, are considered to be one accounting unit and, once all services have commenced, are recognized ratably over the remaining period of the arrangement which consists of the longer of the contractual service term or PCS term. If the professional services are essential to the functionality of the software products, then revenue recognition does not commence until such services are completed.

Our term-based software license arrangements typically have a term of 12 months and include PCS, including the right to receive unspecified software upgrades, when and if available during the license term. We do not charge separately for PCS. Revenues for software licenses sold on a term-based model basis are recognized ratably over the term of the license arrangement, once all other revenue recognition criteria have been met.

We also sell perpetual licenses to certain of our customers. We do not have VSOE of fair value for the PCS, which is sold along with the perpetual licenses. As a result, revenue from these perpetual arrangements is recognized ratably over the initial PCS term.

### Software related services

Software related services revenue is derived from our consulting, implementation services and training for product design and development projects.

Software services are provided to customers on a time and materials or fixed-price basis. We recognize software services revenue for time and materials contracts based upon hours worked and contractually agreed-upon hourly rates. Revenue from fixed-price engagements is recognized using the proportional performance method based on the ratio of costs incurred, to the total estimated project costs. Project costs are based on standard rates, which vary by the consultant's professional level, plus all direct expenses incurred to complete the engagement that are not reimbursed by the client. Project costs are typically expensed as incurred. The use

## [Table of Contents](#)

of the proportional performance method is dependent upon management's ability to reliably estimate the costs to complete a project. We use historical experience as a basis for future estimates to complete current projects. Additionally, we believe that costs are the best available measure of performance. If the costs to complete a project are not estimable or the completion is uncertain, the revenue is recognized upon completion of the services.

### *Client engineering services*

CES revenue is derived from our hiring of engineers for placement at a customer site for specific customer-directed assignments. These engineers are hired and paid only for the duration of the placement. We recognize client engineering services revenue based upon hours worked and contractually agreed-upon hourly rates.

### *Other*

Other revenue is derived from the sale of LED products for the replacement of fluorescent tubes. Revenue from the sale of LED products for the replacement of fluorescent tubes is recognized when all revenue recognition criteria stated above are met, which is generally when the products are transferred to resellers or to end customers. We recognize revenues from royalties for licensing our technology when received.

### **Goodwill and indefinite-lived intangible assets**

In accordance with ASC Topic 360, we conduct an assessment of the carrying value of goodwill each year, based on weighting estimates of future cash flows from the reporting units or estimates of the market value of the reporting units, based on comparable companies. We also perform impairment analyses whenever events or circumstances indicate that goodwill or certain intangibles may be impaired. These estimates of future discounted cash flows are based upon historical results, adjusted to reflect our best estimate of future market and operating conditions. Historically, actual results have occasionally differed from our estimated future cash flow estimates. In the future, actual results may differ materially from these estimates. In addition, the comparable companies used to establish market value for our reporting units is based on management's judgment.

The timing and size of any future impairment charges involves the application of our estimates and judgment and could result in the impairment of all, or substantially all, of our goodwill or intangible assets.

### **Stock-based compensation**

Stock-based compensation expense, consisting of stock options expected to be settled by issuing shares of our common stock, are recorded as equity awards. The fair value of these awards on the date of grant is measured using the Black-Scholes option pricing model.

Our use of the Black-Scholes option-pricing model requires the input of highly subjective assumptions, including the fair value of our underlying common stock, expected term of the option, expected volatility of the price of our common stock, risk-free interest rates, and expected dividend yield. The assumptions used in our option-pricing model represent management's best estimates. These estimates involve inherent uncertainties and the application of management's judgment. If factors change and different assumptions are used, our stock-based compensation expense could be materially different in the future.

These assumptions and estimates are as follows:

- *Fair value of common stock.* Due to the absence of an active market for our common stock, our board of directors, with the assistance of a third-party valuation specialist, determines the fair value of our common stock. The valuation methodology includes estimates and assumptions including forecasts of future cash

## [Table of Contents](#)

flows that require significant judgments. These valuations consider a number of objective and subjective factors, including our actual operating and financial performance, external market conditions, performance of comparable publicly traded companies, comparable transactions, business developments, likelihood of achieving a liquidity event, such as an initial public offering or sale, and common stock transactions, among other factors. We utilized methodologies in accordance with the framework of the American Institute of Certified Public Accountants' Technical Practice Aid, *Valuation of Privately-Held Company Equity Securities issued as Compensation*, to estimate the fair value of its common stock. Significant changes to the key assumptions used in the valuations could result in different fair values of our common stock at each valuation date.

- *Expected term.* The expected term of employee stock options represents the weighted-average period that the stock options are expected to remain outstanding. To determine the expected term, we generally apply the simplified approach in which the expected term of an award is presumed to be the mid-point between the vesting date and the expiration date of the award as we do not have sufficient historical exercise data to provide a reasonable basis for an estimate of expected term.
- *Risk-free interest rate.* We base the risk-free interest rate on the yields of United States Treasury securities with maturities approximately equal to the term of employee stock option awards.
- *Expected volatility.* As we do not have a trading history for our common stock, the expected volatility for our common stock was estimated by taking the average historic price volatility for industry peers based on daily price observations over a period equivalent to the expected term of the stock option awards. Industry peers consist of several public companies in our industry which are either similar in size, stage of life cycle or financial leverage.

We must also estimate a forfeiture rate to calculate the stock-based compensation expense for our awards. Our forfeiture rate is based on an analysis of our actual forfeitures. We will continue to evaluate the appropriateness of the forfeiture rate based on actual forfeiture experience, analysis of employee turnover and other factors. A higher revised forfeiture rate than previously estimated will result in an adjustment that will decrease the stock-based compensation expense recognized in the consolidated statement of operations. A lower revised forfeiture rate than previously estimated will result in an adjustment that will increase the stock-based compensation expense recognized in the consolidated statement of operations.

We will continue to use judgment in evaluating the assumptions related to our stock-based compensation on a prospective basis. As we continue to accumulate additional data related to our common stock, we may have refinements to our estimates, which could materially impact our future stock-based compensation expense.

Employee stock-based awards, consisting of stock options with repurchase features that allow them to be settled in cash at a purchase price that is less than the current fair value are considered liability-based awards. These awards are initially recorded at fair value and remeasured to fair value at the end of each reporting period until settled.

Our 2001 ISO and NQSO Plan was terminated in 2011. Options granted under the 2001 ISO and NQSO Plan are accounted for as liability awards as the terms of the awards could require or allow repurchase of the shares at amounts different than fair value. We made the accounting policy election to use the intrinsic value method of accounting to determine stock-based compensation liabilities for these awards. During the quarter ended June 30, 2017, in accordance with ASC 718 as we no longer meet the definition of a nonpublic entity, we changed our accounting policy to measure the fair value of our liability awards using the Black-Scholes option pricing model. The impact of the change in accounting policy was immaterial to the financial statements.

## [Table of Contents](#)

The 2001 ISO and NQSO Plan also includes stock-based compensation liability for our new Class A redeemable common shares outstanding resulting from our call feature with a purchase price that may be set at less than the fair market value at the redemption date. We utilized the fair value of the outstanding new Class A redeemable common shares to determine the stock-based compensation liabilities for these redeemable common shares. We expect a one-time significant decrease in our stock-based compensation liability in the period following this offering, as the call feature is terminated upon certain triggering events, including an initial public offering in which our capital stock is admitted to and begins trading on any United States securities exchange.

### *Accounting for income taxes*

We utilize the asset and liability method of accounting for income taxes in accordance with ASC Topic 740, *Accounting for Income Taxes*. Under this method, deferred tax assets and liabilities are determined based on differences between the financial reporting and tax bases of assets and liabilities. Deferred tax assets and liabilities are measured using the enacted tax rates and statutes that will be in effect when those differences are expected to reverse. Deferred tax assets can result from unused operating losses, research and development credits, foreign tax credit carryforwards, and deductions recorded for financial statement purposes prior to them being deductible on a tax return. Valuation allowances are provided against net deferred tax assets if, based upon the available evidence, it is more likely than not that some or all of the deferred tax assets will not be realized. The ultimate realization of deferred tax assets is dependent upon the generation of future taxable income and the reversal of taxable temporary differences. We consider, among other available information, scheduled reversals of deferred tax liabilities, projected future taxable income, limitations on the availability of tax credit carryforwards, and other evidence assessing the potential realization of deferred tax assets. Adjustments to the valuation allowance are included in the tax provision in our consolidated statements of operations in the period they become known or can be estimated.

Significant management judgment is required in determining any valuation allowance recorded against deferred tax assets and liabilities. The valuation allowance is based on our estimates of taxable income for jurisdictions in which we operate and the period over which our deferred tax assets may be recoverable. Historically, we have had substantial United States tax credit carryforwards which, if not utilized, will begin to expire in 2018. The ability to utilize these DTAs is highly dependent upon our ability to generate taxable income in the United States in the future.

We apply a more-likely-than-not recognition threshold to our accounting for tax uncertainties. We review all of our tax positions and make determinations as to whether our tax positions are more likely than not to be sustained upon examination by the relevant taxing authorities. Only those benefits that have a greater than fifty percent likelihood of being sustained upon examination by taxing authorities are recognized. Interest and penalties related to uncertain tax positions are recorded in income tax expense (benefit) in the consolidated statements of operations.

### **Quantitative and qualitative disclosures about market risk**

We are exposed to certain global market risks, including foreign currency exchange risk and interest rate risk associated with our debt.

#### ***Foreign currency exchange risk***

As a result of our substantial international operations, we are exposed to foreign currency risks that arise from our normal business operations, including in connection with our transactions that are denominated in foreign currencies, including Euro, British Pound Sterling, Indian Rupee, Japanese Yen, and Chinese Yuan. In addition,

## [Table of Contents](#)

We translate sales and financial results denominated in foreign currencies into United States dollars for purposes of our consolidated financial statements. As a result, appreciation of the United States dollar against these foreign currencies generally will have a negative impact on our reported revenues and operating income while depreciation of the United States dollar against these foreign currencies will generally have a positive effect on reported revenues and operating income.

### **Interest rate sensitivity**

We are exposed to market risks in the ordinary course of our business. These risks primarily include interest rate sensitivities. As of June 30, 2017, and December 31, 2016, we had cash, cash equivalents and restricted cash of \$17.7 million and \$17.1 million, respectively, consisting primarily of bank deposits. As of June 30, 2017, and December 31, 2016, respectively, we had \$52.5 million and \$57.5 million outstanding on Term Loan A and \$18.0 million and \$27.4 million outstanding on our Revolving Credit Facility. Such interest-bearing instruments carry a degree of interest rate risk; however, historical fluctuations of interest expense have not been significant.

Interest rate risk relates to the gain/increase or loss/decrease we could incur on our debt balances and interest expense associated with changes in interest rates. It is our policy not to enter into derivative instruments for speculative purposes, and therefore, we hold no derivative instruments for trading purposes.

### **Non-GAAP financial measures**

In analyzing and planning for our business, we supplement our use of GAAP financial measures with non-GAAP financial measures, including Billings as a liquidity measure, Adjusted EBITDA as a performance measure and Free Cash Flow as a liquidity measure.

(in thousands)	Year ended December 31,		Six months ended June 30,	
	2015	2016	2016	2017
<b>Other Financial Data:</b>				
Billings	\$297,358	\$320,653	\$165,449	\$181,379
Adjusted EBITDA	22,949	30,830	12,933	7,056
Free Cash Flow	5,605	11,941	18,307	21,782

Billings consists of our total revenue plus the change in our deferred revenue. Billings is a non-GAAP financial measure. Given that we generally bill our customers at the time of sale, but typically recognize a majority of the related revenue ratably over time, management believes that Billings is a meaningful way to measure and monitor our ability to provide our business with the working capital generated by upfront payments from our customers.

We define Adjusted EBITDA as net income (loss) adjusted for income tax expense (benefit), interest expense, interest income and other, depreciation and amortization, stock-based compensation expense, restructuring charges, asset impairment charges and other special items as determined by management. Adjusted EBITDA is a non-GAAP financial measure. Our management team believes that Adjusted EBITDA is a meaningful measure of performance as it is commonly utilized by management and the investment community to analyze operating performance in our industry.

We define Free Cash Flow as cash flow provided by operating activities less capital expenditures. Free Cash Flow is a non-GAAP financial measure. Management believes that Free Cash Flow is useful in analyzing our ability to service and repay debt and return value directly to stockholders.

## [Table of Contents](#)

These non-GAAP financial measures reflect an additional way of viewing aspects of our business that, when viewed with our GAAP results and the accompanying reconciliations to the corresponding GAAP financial measures included in the tables below, may provide a more complete understanding of factors and trends affecting our business. These non-GAAP financial measures should not be relied upon to the exclusion of GAAP financial measures and are by definition an incomplete understanding of the Company and must be considered in conjunction with GAAP measures.

We believe that the non-GAAP measures disclosed herein are only useful as an additional tool to help management and investors make informed decisions about our financial and operating performance and liquidity. By definition, non-GAAP measures do not give a full understanding of the Company. To be truly valuable, they must be used in conjunction with the comparable GAAP measures. In addition, non-GAAP financial measures are not standardized. It may not be possible to compare these financial measures with other companies' non-GAAP financial measures having the same or similar names. We strongly encourage investors to review our consolidated financial statements and the notes thereto in their entirety and not rely on any single financial measure.

The following tables provide reconciliations of revenue to Billings, income (loss) before income taxes to Adjusted EBITDA and net cash provided by operating activities to Free Cash Flow:

### **Billings**

<b>(in thousands)</b>	<b>Year ended December 31,</b>		<b>Six months ended June 30,</b>	
	<b>2015</b>	<b>2016</b>	<b>2016</b>	<b>2017</b>
Revenues	\$ 294,129	\$ 313,240	\$ 152,340	\$ 158,528
Ending deferred revenue	106,516	113,929	119,625	136,780
Beginning deferred revenue	(103,287)	(106,516)	(106,516)	(113,929)
Billings	\$ 297,358	\$ 320,653	\$ 165,449	\$ 181,379

### **Adjusted EBITDA**

<b>(in thousands)</b>	<b>Year Ended December 31,</b>		<b>Six months ended June 30,</b>	
	<b>2015</b>	<b>2016</b>	<b>2016</b>	<b>2017</b>
Net income (loss)	\$10,931	\$10,163	\$ 3,953	\$ (9,434)
Income tax expense (benefit)	818	3,539	2,699	(1,659)
Stock-based compensation	597	5,132	175	14,037
Interest expense	2,416	2,265	1,247	1,159
Interest income and other <sup>(1)</sup>	(191)	(249)	12	(2,131)
Depreciation and amortization	8,378	9,980	4,847	5,084
Adjusted EBITDA	\$22,949	\$30,830	\$12,933	\$ 7,056

(1) Includes a non-recurring adjustment for a change in estimated legal expenses resulting in \$2 million of income for the six months ended June 30, 2017.

### **Free cash flow**

<b>(in thousands)</b>	<b>Year ended December 31,</b>		<b>Six months ended June 30,</b>	
	<b>2015</b>	<b>2016</b>	<b>2016</b>	<b>2017</b>
Net cash provided by operating activities	\$10,838	\$21,385	\$ 22,006	\$ 26,117
Capital expenditures	(5,233)	(9,444) <sup>(1)</sup>	(3,699)	(4,335) <sup>(2)</sup>
Free Cash Flow	\$ 5,605	\$11,941	\$ 18,307	\$ 21,782

(1) Includes \$4.0 million purchase of real property adjacent to our corporate headquarters.

(2) Includes \$2.0 million for the purchase of developed technology.

## **JOBS Act Accounting Election**

We are an emerging growth company, as defined in the Jumpstart Our Business Startups Act of 2012, or the JOBS Act. Under the JOBS Act, emerging growth companies can delay adopting new or revised accounting standards issued subsequent to the enactment of the JOBS Act until such time as those standards apply to private companies. We have elected to use this extended transition period for complying with new or revised accounting standards that have different effective dates for public and private companies until the earlier of the date we (i) are no longer an emerging growth company or (ii) affirmatively and irrevocably opt out of the extended transition period provided in the JOBS Act. As a result, our financial statements may not be comparable to companies that comply with new or revised accounting pronouncements as of public company effective dates.

## **Recently issued accounting pronouncements**

### ***Accounting standards adopted***

We adopted Accounting Standards Update, "ASU" No. 2014-15, *Presentation of Financial Statements—Going Concern*, effective for the year ended December 31, 2016. This update provides guidance regarding management's responsibility to evaluate whether there exists substantial doubt about an organization's ability to continue as a going concern and to provide related footnote disclosures in certain circumstances. The adoption did not have a material effect on our consolidated financial statements.

We adopted ASU No. 2015-03, *Simplifying the Presentation of Debt Issuance Costs*, ASU 2015-03, effective for the year ended December 31, 2016. This update amended existing guidance to require that debt issuance costs related to a recognized debt liability be presented in the balance sheet as a direct reduction from the carrying amount of that debt liability, consistent with debt discounts. ASU 2015-03 was applied retrospectively and did not have a material effect on the Company's consolidated financial statements.

We adopted ASU No. 2015-05, *Intangibles—Goodwill and Other—Internal-Use Software (Subtopic 350-40): Customer's Accounting for Fees Paid in a Cloud Computing Arrangement*, ASU 2015-05, effective for the year ended December 31, 2016. The amendments in this update provided guidance to customers about whether a cloud computing arrangement includes a software license. If a cloud computing arrangement includes a software license, then the customer should account for the software license element of the arrangement consistent with the acquisition of other software licenses. If a cloud computing arrangement does not include a software license, the customer should account for the arrangement as a service contract. The guidance did not change United States GAAP for a customer's accounting for service contracts. ASU 2015-05 was applied retrospectively and did not have a material effect on the Company's consolidated financial statements.

We adopted ASU No. 2015-16, *Business Combinations: Simplifying the Accounting for Measurement-Period Adjustments*, ASU 2015-16, effective for the year ended December 31, 2016. The amendments in ASU 2015-16 eliminate the requirement to restate prior period financial statements for measurement period adjustments. The amendments also require that the cumulative impact of a measurement period adjustment (including the impact on prior periods) be recognized in the reporting period in which the adjustment is identified. The amendments for ASU-2015-16 were prospectively applied and did not have a material effect on our consolidated financial statements.

We adopted ASU No. 2016-18, *Statement of Cash Flows (Topic 230): Restricted Cash*, ASU 2016-18, effective as of December 15, 2017. ASU 2016-18 clarifies the presentation of restricted cash and restricted cash equivalents in the statements of cash flows. Under ASU 2016-18 restricted cash and restricted cash equivalents are included with cash and cash equivalents when reconciling the beginning-of-period and end-of-period total amounts shown on the statements of cash flows. We early adopted ASU No 2016-18 in 2016 on a retrospective basis, and the adoption did not have a material effect on our consolidated financial statements.



## [Table of Contents](#)

We adopted ASU No. 2015-11, *Inventory: Simplifying the Measurement of Inventory*, ASU 2015-11, effective for fiscal years and interim periods beginning after December 15, 2016. ASU 2015-11 requires an entity to measure inventory within the scope at the lower of cost and net realizable value. Net realizable value is the estimated selling prices in the ordinary course of business, less reasonable predictable costs of completion, disposal and transportation. We adopted ASU No 2015-11 on January 1, 2017, on a prospective basis, and the adoption did not have a material effect on our consolidated financial statements.

### **Accounting standards not yet adopted**

**Revenue Recognition**—In May 2014, the Financial Accounting Standards Board, or “FASB”, issued ASU No. 2014-09, *Revenue from Contracts with Customers*, ASU 2014-09. This standard outlines a single comprehensive model for entities to use in accounting for revenue arising from contracts with customers and supersedes most existing revenue recognition guidance under GAAP. The core principle of the guidance is that an entity should recognize revenue when it transfers promised goods or services to customers in an amount that reflects the consideration to which the company expects to be entitled in exchange for those goods or services. ASU 2014-09 also requires enhanced disclosures about the nature, amount, timing, and uncertainty of revenues and cash flows arising from contracts with customers. Entities have the option of using either a full retrospective or a modified retrospective approach for the adoption of the new standard. In August 2015, the FASB issued ASU 2015-14, *Revenue from Contracts with Customers: Deferral of the Effective Date* that defers the effective date of ASU 2014-09 for all entities by one year for public business entities. This ASU is effective for fiscal years beginning after December 15, 2017 including interim periods within that reporting period. For all other entities, including emerging growth companies, this ASU is effective for fiscal years beginning after December 15, 2018, and interim periods within annual periods beginning after December 15, 2019. Early adoption is permitted.

We are evaluating the use of either the retrospective or modified retrospective transition method. Under existing software industry GAAP, we do not have VSOE of fair value for PCS sold along with software products licenses; therefore, revenues for the software products licenses (including perpetual licenses), PCS and professional services, if applicable, are considered to be one accounting unit and, once all services have commenced, are recognized ratably over the remaining period of the arrangement (the longer of the contractual service term or PCS term). Under ASU 2014-09, the concept of assessing VSOE has been eliminated and the Company must estimate a fair value associated with each performance obligation within an arrangement. As a result, we expect the timing of revenue recognition to be accelerated because it anticipates that license revenue will be recognized at a point in time, rather than over time, which is its current practice. Generally, the license revenue component of an arrangement represents a significant portion of the overall fair value of a software arrangement. As a result, we expect the impact of adopting ASU 2014-09 to have a significant impact on the consolidated financial statements. We are currently evaluating the method of implementation and impact this standard will have on its consolidated financial statements.

**Financial Instruments**—In January 2016, the FASB issued ASU No. 2016-01, *Financial Instruments—Overall: Recognition and Measurement of Financial Assets and Financial Liabilities*, ASU 2016-01. This standard affects the accounting for equity instruments, financial liabilities under the fair value option and the presentation and disclosure requirements of financial instruments. ASU 2016-01 is effective in the first quarter of 2019. We are evaluating the impact of the adoption of ASU 2016-01 on its financial statements and related disclosures.

**Leases**—In February 2016, the FASB issued ASU No. 2016-02, *Leases*, ASU 2016-02. This standard amends various aspects of existing accounting guidance for leases, including the recognition of a right-of-use asset and a lease liability on the balance sheet for all leases with terms longer than 12 months. Leases will be classified as either finance or operating, with classification affecting the pattern of expense recognition in the income statement. This standard also introduces new disclosure requirements for leasing arrangements. ASU 2016-02

## [Table of Contents](#)

is effective for fiscal years beginning after December 15, 2018, including interim periods within those fiscal years for public business entities. For all other entities, including emerging growth companies, ASU 2016-02 is effective for fiscal years beginning after December 15, 2019, including interim periods within those fiscal years beginning after December 15, 2020. Early adoption is permitted. The new standard must be adopted using a modified retrospective approach, and provides for certain practical expedients. We are evaluating the impact of the adoption of ASU 2016-02 on its financial statements and related disclosures.

*Employee Share-Based Payment Accounting*—In March 2016, FASB issued ASU No. 2016-09, *Improvements to Employee Share-Based Payment Accounting*, ASU 2016-09. This standard involves several aspects of the accounting for share-based payment transactions, including the income tax consequences, classification of awards as either equity or liabilities and classification on the statement of cash flows. ASU 2016-09 is effective for annual periods beginning after December 15, 2016 and interim periods within those annual periods for public business entities. For all other entities, including emerging growth companies, ASU 2016-09 is effective for annual periods beginning after December 15, 2017 and interim periods within fiscal years beginning after December 15, 2018. The method of adoption is dependent on the specific aspect of accounting addressed in this new guidance. Early adoption is permitted in any interim or annual period. We are evaluating the impact of the adoption of ASU 2016-09 on our financial statements and related disclosures.

*Cash Classification*—In August 2016, the FASB issued ASU No. 2016-15, *Statement of Cash Flows (Topic 230): Classification of Certain Cash Receipts and Cash Payments*, ASU 2016-15, to improve financial reporting in regards to how certain transactions are classified in the statement of cash flows. ASU 2016-15 provides guidance for targeted changes with respect to how cash receipts and cash payments are classified in the statements of cash flows, with the objective of reducing diversity in practice. ASU 2016-15 is effective for interim and annual periods beginning after December 15, 2017. For all other entities, including emerging growth companies, ASU 2016-15 is effective for fiscal years beginning after December 15, 2018, and interim periods within fiscal years beginning after December 15, 2019. Early adoption is permitted. We are evaluating the impact of the adoption of ASU No. 2016-15 on our financial statements and related disclosures.

*Business Combinations*—In January 2017, the FASB issued ASU No. 2017-01, *Business Combinations (Topic 805): Clarifying the Definition of a Business*, or ASU\_2017-01. This update narrows the definition of a business. If substantially all the fair value of the gross assets acquired is concentrated in a single identifiable asset or group of similar identifiable assets, the acquiree is not a business. The update also requires a business to include an input and a substantive process that significantly contributes to the ability to create outputs. This definition is expected to reduce the number of acquisitions accounted for as business combinations, which will impact the accounting treatment of certain items, including the accounting treatment of contingent consideration and transaction expenses. ASU 2017-01 is effective for annual periods beginning after December 15, 2017, including interim periods within that reporting period. For all other entities, including emerging growth companies, ASU 2017-01 is effective for annual periods beginning after December 15, 2018, and interim periods within annual periods beginning after December 15, 2019. Early adoption is permitted and the update will be applied prospectively. The effect of the implementation will depend upon the nature of our future acquisitions.

# Business

## Vision

Our vision is to transform product design and organizational decision making by applying simulation, optimization and high performance computing throughout product lifecycles.

## Overview

*Altair exists to unleash the limitless potential of the creative mind.*

We are a leading provider of enterprise-class engineering software enabling innovation across the entire product lifecycle from concept design to in-service operation. Our simulation-driven approach to innovation is powered by our broad portfolio of high-fidelity and high-performance physics solvers. Our integrated suite of software optimizes design performance across multiple disciplines encompassing structures, motion, fluids, thermal management, electromagnetics, system modeling and embedded systems, while also providing data analytics and true-to-life visualization and rendering.

The engineering software industry is challenged by increasingly sophisticated design requirements and enabled by the ever expanding availability of cost effective computing power. Rising expectations of end-market customers, new manufacturing methods such as 3D printing, and new materials such as composites, combined with more powerful math-based computational technologies, are expanding the application of simulation across many industry verticals. The Internet of Things, or IoT, is also changing engineering by broadening the scope of Product Lifecycle Management, or PLM, affording the opportunity to leverage simulation and analytics toward the development of “digital twins” to predict failure or to schedule maintenance operations for in-service equipment.

CIMdata, in the CIMdata Report, forecasts, “the PLM market to grow at a compound annual growth rate (CAGR) of 6.7% to \$56.3 billion” in 2021. The CIMdata Report estimates the CAE market which they refer to as Simulation and Analysis, as a subset of the PLM market to be approximately \$5.3 billion and \$5.7 billion in 2016 and 2017, respectively. The CIMdata Report expects the CAE market, “will be one of the more rapidly growing segments within the tools sector of PLM over the next five years, and forecasts that this market sector will exceed \$7.8 billion in 2021, with an 8.1% CAGR.”

Altair’s engineering and design platform offers a wide range of multi-disciplinary CAE solutions which we believe is one of the most innovative and comprehensive offerings available in the market. To ensure customer success and deepen our relationships with them, we engage with our customers to provide consulting, implementation services, training, and support, especially when applying optimization. Altair participates in five software categories related to CAE and HPC:

- **Solvers & Optimization:** Solvers are mathematical software “engines” that use advanced computational algorithms to predict physical performance. Optimization leverages solvers to derive the most efficient solutions to meet desired complex multi-objective requirements.
- **Modeling & Visualization:** Tools that allow advanced physics attributes to be modeled and rendered on top of object geometry in high fidelity. These tools are becoming more design-centric and relevant earlier in the development process.
- **Industrial & Concept Design:** Tools that generate early concepts to address requirements for ergonomics, aesthetics, performance, and manufacturing feasibility. These tools are simulation-driven and, we believe, emerging as a market force eclipsing traditional CAD.
- **IoT:** Tools to develop new IoT enabled products, including device and data management, system level and full 3D digital twin simulation, and exploration, predictive analysis, optimization, and visualization of in-service performance.

- **HPC:** Software applications that streamline the workflow management of compute-intensive tasks including solvers, optimization, modeling, visualization, and analytics in fields such as PLM, weather modeling, bio-informatics and electronic design analysis. The HPC middleware software market was forecasted by the former high performance analyst team which is now owned by Hyperion, and not IDC, to exceed \$1.6 billion by 2019.

Our software enables customers to enhance product performance, compress development time, and reduce costs. Our thirty-year heritage is in solving some of the most challenging design problems faced by engineers and scientists. Altair is also a leading provider of high-performance computing workflow tools which empower our customers to explore designs in ways not possible in traditional computing environments. We believe we are unique in the industry for the depth and breadth of our engineering application software offerings combined with our domain expertise and proprietary technology for harnessing HPC and cloud infrastructures.

Our primary users are highly educated and technical engineers, commonly referred to as simulation specialists. We predominantly reach customers with simulation specialists through Altair's experienced, direct sales force, especially in industries requiring highly engineered products, such as automotive, aerospace, heavy machinery, rail and ship design. To enable concept engineering driven by simulation we make our physics solvers more accessible to designers, who may be less technical and not expert in simulation, by wrapping them in powerful, yet simple interfaces. We are increasing our use of indirect channels to more efficiently address a broader set of customers in consumer products, electronics, energy and other industries.

Altair pioneered a patented units-based subscription licensing model for software and other digital content. This units-based model allows flexible and shared access to all of our offerings, along with over 150 partner products. Our customers license a pool of units for their organizations giving individual users access to our entire portfolio of software applications as well as our growing portfolio of partner products. We believe our units-based subscription licensing model lowers barriers to adoption, creates broad engagement, encourages users to work within our ecosystem, and increases revenue. This, in turn, helps drive our recurring software license rate which has been on average approximately 88% over the past five years. Each year approximately 60% of new software revenue comes from expansion within existing customers.

Altair also provides CES to support our customers with long-term ongoing product design and development expertise. This has the benefit of embedding us within customers, deepening our understanding of their processes, and allowing us to more quickly perceive trends in the overall market. Our presence at our customers' sites helps us to better tailor our software products' R&D and sales initiatives.

We were founded in 1985 in Michigan and have a balanced global footprint, with 68 offices in 24 countries, and over 2,000 engineers, scientists and creative thinkers. For the six months ended June 30, 2017, we generated 34%, 33% and 33% of our total billings from customers in the Americas, the APAC region, and the EMEA region, respectively. In 2016, we generated 38%, 32% and 30% of our total billings from customers in the Americas, APAC, and EMEA, respectively. Billings by geographical region can significantly vary by quarter. As of June 30, 2017, we had tens of thousands of users across approximately 5,000 customers worldwide. See the section entitled "Selected historical consolidated financial and other data—Key metrics."

We believe a critical component of our success has been our company culture, based on our core values of innovation, envisioning the future, communicating honestly and broadly, seeking technology and business firsts, and embracing diversity. This culture is important because it helps attract and retain top people, encourages innovation and teamwork, and enhances our focus on achieving Altair's corporate objectives.

## Industry background

CAE software is essential to innovation across a wide range of highly engineered products in industry verticals ranging from automotive, aerospace, heavy machinery, rail and ship design to consumer electronics and sporting goods. Physical prototypes and testing have been largely supplanted by CAE for design validation over the last twenty-five years. This process continues unabated. Manual drawing and drafting were also replaced by 3D CAD during the same time period. More recently, CAE is emerging in a conceptualization process called simulation-driven design where new design tools are beginning to replace traditional 3D CAD.

CAE software allows engineers to simulate, predict, and optimize how physical products will perform in the real world under a range of operating conditions. CAE applications can accurately solve complex physical interactions through mathematical methods such as finite element analysis, simulate an extensive set of material types, and generate high-fidelity outputs that are realistic virtual representations of physical system behaviors. Modern CAE software can rapidly solve a wide range of complex physics, including structural, fluid, thermal, electromagnetic, system modeling, and embedded system design.

Beyond just simulating physical behavior, CAE can now solve multi-disciplinary optimization problems to numerically optimize parameters and achieve design objectives such as to minimize weight or cost. Utilizing such advanced simulation and optimization methods, engineers and designers can shorten development cycles, virtually test product performance, explore alternatives, and synthesize designs that enhance product functionality, performance and reliability while reducing complexity and costs.

### ***Principal drivers of growth in demand for simulation & analysis software include:***

#### *Improving sophistication and fidelity of CAE technologies*

The engineering software industry is challenged by increasingly sophisticated design requirements and enabled by the ever-expanding availability of cost effective computing power. Simulation models continue to grow in size, complexity, and range of physics, driving demand for additional computational power and parallelization algorithms, more powerful modeling and visualization tools and more advanced multi-physics solvers. Advances in computing infrastructure have kept pace over time, drastically reducing the time it takes to perform complex simulations and solve large-scale problems such as automotive crash simulation, fluid-structure interaction of subsea oil pipelines and detailed composite simulation of full aircraft structures. As these models continue to grow larger and solve faster, the knowledge and power of these methods to impact design decisions expands across a department, an industry, or from one industry to another, fueling consumption of CAE software.

#### *Fundamental transformations in product engineering*

The nature of modern manufactured products is rapidly evolving toward intelligent, connected systems. Once composed solely of mechanical parts, products have become complex systems often combining mechanical hardware, electronics, sensors, controls, software, and communications in myriad ways to monitor and adjust behavior using embedded logic. Advanced driver-assistance systems, or ADAS, autonomous vehicles, or AVs, modern industrial robots and most new consumer products are examples of this new paradigm. This complex interplay across domains is forcing engineers to take a systems-level approach to design, and in turn to rely on advanced computer-aided systems simulation as a necessity in product design. Controls algorithm development, modeling of linked systems, and transfer of control logic into embedded systems can all be done using CAE software to achieve optimal performance and cost and ensure product integrity while minimizing physical prototype iterations.

### *Democratization of CAE*

CAE software access was historically limited to a small pool of specialist engineers in large organizations with a high level of domain expertise and knowledge of complex mathematical modeling and underlying physics. Exploring different product design ideas at the same time through simulation software required reliable, secure, and dedicated high-speed computing infrastructure, which was typically expensive to own and operate. The dramatic increase in computing performance, and an equally dramatic reduction in computing cost over the last twenty years coupled with the growth of cloud computing is making CAE, and especially optimization, cost effective. Coupled with user-friendly software applications which make multi-run design studies less expensive, businesses have the opportunity to expand their CAE user community and overall application of simulation.

We believe record numbers of engineers and designers involved in product development now have access to CAE tools, and any one engineer involved in product development has access to more CAE tools than ever, thus driving increased adoption of CAE solutions across large organizations and by small and medium businesses.

### *An emerging paradigm of simulation-driven design*

Simulation is now driving design innovation, rather than following design. The product development process of recent decades involved creation of a product concept followed by development of a detailed design using 3D CAD. The designs were then passed along to engineering teams to refine, test and optimize. CAE was often too late or too slow to effectively impact the rapid decisions required to correct flawed product designs. Design changes late in the product development process are costly, may delay product launches, and can adversely affect product quality and performance.

Democratization of CAE offers product designers easy access to a user-friendly subset of simulation tools to take into account product performance objectives and manufacturability early in the design process. Going forward, engineering specialists can focus more on detailed validations and complex simulations. This is driving a positive movement toward simulation-driven design processes and a corresponding growth in simulation software consumption.

### *Expanding scope of simulations to “Digital Twins”*

The evolution of products into intelligent, connected devices—which are increasingly embedded in broader systems—is reshaping how products are engineered, manufactured, operated and serviced. Smart, connected products underpin the IoT and generate vast amounts of actionable data. As consumers and industries begin to realize tangible benefits from connected products, IoT adoption is accelerating. Gartner estimates that the installed base of IoT units will grow to reach more than 20 billion units by 2020.\*

CAE software combined with advanced analytics and operating data from sensors make it possible for manufacturers to improve product performance through complete life-cycles. In-service measurements, combined with simulation models, or digital twins, provide information to predict and prescribe maintenance of components or systems. The IoT is changing engineering by broadening the scope of PLM to leverage simulation and analytics for better and more robust manufacturing and in-service operation.

### **Market opportunity**

Rising expectations of end-market customers, new manufacturing methods such as 3D printing, the ability to design and process composites and new materials, combined with more powerful math-based computational technologies, are expanding the application of simulation across many industry verticals and throughout

## [Table of Contents](#)

product life-cycles. CAE software offers companies opportunities to achieve better, lower cost products with fewer physical prototypes and tests, and reduces the time required to bring products to market.

The CIMdata Report, forecasts, “the PLM market to grow at a compound annual growth rate (CAGR) of 6.7% to \$56.3 billion” in 2021. The CIMdata Report estimates the CAE market which they refer to as Simulation and Analysis, as a subset of the PLM market to be approximately \$5.3 billion and \$5.7 billion in 2016 and 2017, respectively. The CIMdata Report expects the CAE market, “will be one of the more rapidly growing segments within the tools sector of PLM over the next five years, and forecasts that this market sector will exceed \$7.8 billion in 2021, with an 8.1% CAGR.”

We believe our strategy of making CAE technologies more accessible through simplified user interfaces with easy access to a broad range of applications and new cloud offerings will help us expand to more designers, engineers and architects at larger companies as well as at small and medium enterprises, thus driving a growth rate that exceeds the overall S&A market. In addition, our recent offerings including software for math-based systems modeling, embedded systems design, and visual analytics present an opportunity to expand our customer base.

Our addressable opportunity also includes software to facilitate and optimize the use of HPC infrastructure critical for running complex simulation models in industries ranging from manufacturing to weather prediction, bio-informatics and financial risk-management. According to the former high performance analyst team which is now owned by Hyperion, and not IDC, the market for high-end HPC servers is estimated to reach \$7 billion by 2020. We believe we are positioned attractively to capture spending related to workload management systems for these high-end servers.

We believe Altair’s simulation and HPC expertise uniquely positions us to address a portion of spending in the massive and fast growing IoT and analytics market. IDC estimates that \$36 billion was spent on IoT platforms in 2015, and estimates the market to grow at a CAGR of 15% through 2020. IDC believes \$19.97 billion was spent on business intelligence and analytics software tools and will grow at a CAGR of 12% through 2021. We have decades of experience helping our customers aggregate, analyze and visualize vast datasets created by large scale simulations, laboratory tests and in-field sensors. Through our IoT and analytics product suite, we are expanding our market reach to a broader set of customers, enabling them to collect and analyze data from an increasing number of connected products to support key business decisions.

## **Competitive strengths**

We believe the following strengths will allow us to maintain and build our position in the growing market for engineering and simulation solutions:

### ***Experienced management and culture of innovation***

As a technology and product driven company, we believe Altair’s culture of innovation creates engagement and loyalty among our employees and customers.

Our founder and leadership team are deeply experienced with a strong track record of both business and product innovation. Our diversified and global workforce is highly experienced and energetic. Altair’s culture affords many opportunities for people to take on new roles and assignments, including significant mobility between locations around the world. Approximately 50% of our employees have been with Altair more than five years and approximately 50% of our managers have a tenure exceeding ten years. Many of our key executives have worked at the company for over 20 years. All of this translates into a significant competitive advantage through deeply rooted institutional knowledge about our market, our competitors’ strengths and weaknesses, and engineering technology.

**Units-based subscription licensing model**

Altair pioneered a patented units-based subscription licensing model for software and other digital content which has transformed the way our customers use software, delivering strong retention rates and revenue growth. Under a traditional software industry licensing model, customers license rights to use a particular application or a suite of applications, which are typically priced on a per CPU basis for a specified period of time. The Altair units-based subscription licensing model is different from the traditional licensing model because it allows customers to license a pool of units for their organizations, providing individual users flexible access to our entire portfolio of software applications along with over 150 partner products. Under the Altair units-based model, customers acquire rights to use a “unit” for a specified period of time. Units are held in a pool and drawn when a user runs any of the applications available under our licensing model, either Altair applications or third-party partner applications. When the user closes the application, the units are returned to the pool and become available for use by all users. In 2016, customers accessed an average of 14.6 applications from our overall portfolio. Altair’s business model is particularly suited to CAE, as engineers and designers often require several different applications across multiple disciplines when developing products. This model lowers barriers to adoption, creates broad engagement, encourages users to work within our ecosystem and access applications they might otherwise have purchased from competitors, and increases revenue. This, in turn, helps drive our recurring software license rate which has been on average approximately 88% over the last five years. Each year approximately 60% of new revenue comes from expansion within existing customers.

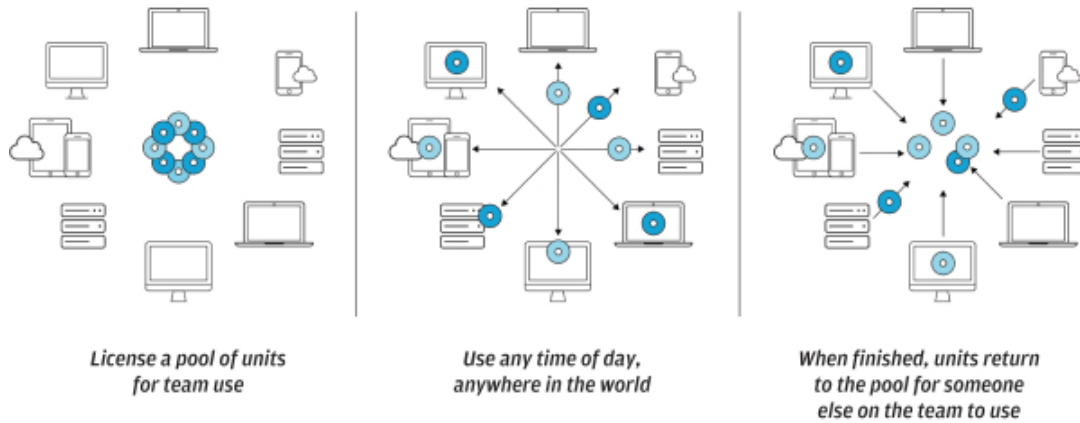

**Broad simulation portfolio and open interfaces**

Altair’s broad portfolio of solutions as well as our open philosophy toward interfacing with other solutions, including competitors, positions us as a strong and strategic partner for customers.

We have assembled one of the broadest portfolios of simulation and optimization applications in the industry, spanning multiple domains and technology disciplines. Our software offers multidisciplinary capabilities in simulation, optimization and predictive analytics. We address the entire product lifecycle including concept design, engineering, manufacturing processes, and in-service operations.

Altair has historically offered broad and complete interfaces to most major third party CAD and CAE software on the market. Customers using a variety of platforms within their enterprises and throughout their supply chain have the ability to use Altair’s software as a central method to share models across multiple formats and between different simulation disciplines.



### ***Industry-leading simulation performance***

Our simulation solutions including modeling, visualization and solvers are noted in the market for their ability to handle large and complex models.

Altair's software applications are highly industrialized and state-of-the-art and take thorough advantage of new compute architectures as they become available including new processors, storage systems, GPUs, and on-premise and public high-performance cloud computing. In addition, we are developing and experimenting with solutions for HPC workload management and remote visualization which will allow the delivery of our own as well as other software via a cloud model.

Our software applications deliver high-performance and high scalability, including massive parallelization, which is increasingly important in the CAE market. This allows our customers to run complex high-fidelity simulations quickly and cost-effectively. As the market moves to drive design with numerical optimization and stochastic studies to improve quality, this requires models to be run multiple times, often with hundreds or thousands of changes to input variables. Compute performance and the ability to run larger models are critical to delivering timely and accurate results, and best-in-class designs.

Altair is a leader in integrating optimization technology across all our products including multi-disciplinary applications. We believe our ability to leverage HPC as the industry transitions to cloud computing also provides an important differentiator.

### ***Deep technical engagement with customers***

Our services including consulting, implementation services, training and support enhance our ability to drive grassroots demand for our applications.

Altair's software related services team is comprised of approximately 700 highly technical people globally and is differentiated by its significant size and the breadth of their real world experience. We believe our approach differentiates us from our competitors, as we focus on establishing a strong working relationship with the user community allowing us to offer guidance and expertise throughout their product creation process.

Altair has a philosophy of significant engagement with strategic customers on key development projects in our software product roadmap to ensure we deliver solutions which are innovative and comprehensive in addressing customer requirements.

We believe our close technical engagement with users, along with senior engineering relationships developed by our sales personnel, helps our ability to sell future products and services.

### **Growth strategies**

We believe the following represent opportunities for Altair's growth in the engineering simulation market:

- Grow market share for solvers;
- Grow indirect business through our OEM and reseller networks;
- Establish leadership position in the expanding Cloud HPC market;
- Expand client adoption for simulation-driven design offerings; and
- Target the emerging IoT market with platform, analytics and digital twin solutions.

## [Table of Contents](#)

We intend to pursue growth by leveraging these opportunities with the following growth strategies:

### ***Increase software usage within our existing customer base***

Our existing base of tens of thousands of users across approximately 5,000 customers provides a significant opportunity to increase revenues. Historically, we have derived 60% of our new software revenue from existing clients. The units-based subscription licensing model lowers barriers to usage, and provides customers the flexibility to initially deploy one or more of our products and later expand usage to more of our applications along with partner products. This land and expand strategy combined with our leadership position in modeling and visualization and our strong portfolio of solver products presents a clear path toward increased usage.

We believe Altair PBS Cloud, complemented by the newly acquired Runtime products, can revolutionize how customer organizations manage their on-premises HPC computing and off-premises cloud infrastructure. As companies transition more HPC workloads to the cloud, we believe Altair PBS Cloud along with Runtime will help them to easily provision, manage and optimize these resources to maximize return on investment.

### ***Invest in our direct sales force***

Our direct sales force is highly technical and experienced, and consistently delivers solid growth and customer loyalty. Our subscription business model sometimes results in smaller new and expansion deal sizes than traditional paid-up licensing approaches. However, our model drives recurring software licenses and consistent growth, creates broad engagement, encourages users to work within our ecosystem, and increases revenue. This drives our recurring software license rate which has been on average approximately 88% over the past five years, and is powerful when competing for new business.

We plan to hire additional field and inside sales professionals in most major markets in which we operate, and to support these teams with continued brand and product marketing. We believe adding sales capacity in our direct sales force will grow revenue.

### ***Expand through indirect sales channels***

We believe there is growth and margin expansion opportunity through our OEM and reseller networks, and we plan to continue adding more partners across all product suites in the future.

solidThinking indirect channels are intended to deliver important new top line growth into middle-market companies not requiring the full suite of enterprise solutions. We plan to focus significant attention on growing our base of Carriots OEMs, implementation partners, and resellers by targeting specific vertical IoT markets. These relationships are important in creating opportunities for digital twin simulation related to the design of, and in-service predictive analytics of, connected products.

### ***Continue investment in R&D***

We organically developed over 15 products which came to market commercially in the last 25 years. These include HyperMesh, HyperView, HyperGraph, OptiStruct, Compose, Activate, Click2Form, HyperStudy, Inspire, MotionView, MotionSolve, Altair PBS Access, Altair PBS Cloud, and Carriots Analytics. We believe this level of organic product creation sustained over such a long period of time is unique in the PLM market.

Analytics from our units-based subscription licensing model gives us insight into our customers' workflows and usage patterns. This helps guide our product development and R&D efforts. We pay attention to how problems are being solved by currently available solutions and look for opportunities to create new products where we

## [Table of Contents](#)

can make significant improvements in quality or performance and deliver future revenue streams for our company. We experiment with new methods and emerging technologies as they become available to learn and to find ways they can be relevant in advancing our products' technologies in the markets we serve.

We view our continued investment in R&D as essential to developing new products and technologies, as well as new features for existing products, to support the needs of our users.

### ***Selectively pursue acquisitions and strategic investments***

We may explore and pursue selective acquisitions and strategic investments to complement and strengthen our product offerings, expand the functionality of our solution, acquire technology or talent, or gain access to new customers and markets.

We acquired 19 companies or strategic technologies since 1996, including 11 in the last three years. These acquisitions brought strategic IP assets, and approximately 200 developers with expertise in disciplines ranging from electronics, material science, crash and safety to industrial design and rendering. Products which are commercially available as a result of these acquisitions include Click2Extrude, Altair PBS Professional, Radioss, Evolve, Acusolve, SimLab, Embed, Click2Cast, Multi-scale Designer, FEKO, FLUX, WinProp, Thea Render, Modeliis, Carriots, and ESAComp.

We believe our ability to integrate expert teams and new IP into our organization, and quickly bring acquired products to market with our business model, is unique in the PLM market.

## **Sales**

We take our products to market in different combinations, through several packaged offerings, each having defined channels and pricing strategies. The product "suites" are HyperWorks, solidThinking, Altair PBS Works and Carriots.

### ***Product suites***

#### *HyperWorks*

HyperWorks is a suite of software products which primarily targets simulation specialists and some test engineers at large enterprises, and users with deep technical needs at small and medium sized companies. HyperWorks Units, or HWUs, are an embodiment of our patented units-based subscription licensing model, and provide access to all of Altair's more than 30 software products including those available in our solidThinking, Altair PBS Works, and Carriots suites, and all of the more than 150 APA products.

HyperWorks represents the majority of Altair's revenue. To sell HyperWorks we primarily engage with our customers through our direct global sales force. Our sales teams interact with key information technology, or IT, decision makers, engage deeply with users of our products by leveraging a team of Altair's technical specialists, and work with user-group managers and executives to ensure they are maximizing the utility of our HyperWorks suite. Resellers of HyperWorks are mainly in APAC and Eastern Europe. They are managed by our direct field offices.

#### *solidThinking*

solidThinking is a more recent suite offering, a subset of our HyperWorks products focused on industrial design, concept engineering, manufacturing feasibility, and model-based design. solidThinking primarily targets

## [Table of Contents](#)

designers, engineers and architects at small and medium enterprises. Historically, solidThinking has been offered under a traditional licensing model. We are currently transitioning to a units-based subscription licensing model similar to HyperWorks.

solidThinking represented less than 1% of Altair's revenue in 2016, while it grew well over 50% from 2015 to 2016. solidThinking Inc. is a wholly owned subsidiary of Altair, created to market this suite through resellers who provide sales and first line support for these customers.

### *Altair PBS Works*

Altair PBS Works is a suite of three products including, Altair PBS Professional, Altair PBS Access, and Altair PBS Cloud, targeting IT professionals, engineers, and scientists at commercial enterprises, universities and research institutes. Altair PBS Works optimizes the use of HPC to design products, predict weather, perform drug discovery research, calculate financial risk, and support other compute intensive work. Altair PBS Works licensing and support is generally on a per node and per user subscription basis.

Altair PBS Works is sold by Altair's global strategic sales force with sales overlay support from Altair HPC sales specialists and application engineers. Some major HPC hardware companies bundle Altair PBS Works on new HPC computer systems. We offer Altair PBS Professional as both an open source and a commercial solution. Commercial sites generally license the commercial version along with support. However, many universities, government agencies and small commercial sites prefer the open source version as their work often needs to be freely available for societal benefit. Large government and research installations generally still purchase support and often pay for specific development.

In September 2017, the Company acquired Runtime. Runtime complements Altair's PBS Works suite of products for comprehensive, secure workload management for HPC and cloud environments and has solutions to manage highly complex workflows. We believe both Runtime and PBS Works deliver innovative and mission critical technology to optimize the use of HPC for compute-intensive applications. PBS Works targets product design, weather prediction, oil exploration and bio-informatics, and Runtime primarily serves customers in EDA.

### *Carriots*

Carriots helps customers enable their products to communicate via numerous standard protocols, perform device and data management, visualize and analyze big data, develop applications, and perform digital twin simulations. Carriots is an end-to-end and open architecture IoT platform. It complements Altair's other product suites to provide a comprehensive solution for customers to design and implement IoT enabled products. The solution is designed with Altair's open philosophy to facilitate seamless integration of its platform elements within customer enterprises to share data and communicate with multiple Enterprise Resource Planning, or ERP, simulation and communication systems.

Carriots is sold by our direct sales force, supported by an overlay team, to customers where we have longstanding relationships as well as to customers in some markets new to Altair. We also sell through resellers and implementation consultants who sell and support Carriots in markets where they are strong.

Carriots Analytics is designed to easily embed in other software products to provide analytics capabilities. We work with other software companies to implement Carriots Analytics in their applications focused on vertical domains where these companies have deep experience and customer relationships.

## **Direct and indirect sales channels**

### *Direct sales channels*

More than 90% of our 2016 software revenue was generated through our direct global sales force. Our direct sales force is responsible for developing new customers, ensuring high recurring rates from our existing customers, and expanding the use of Altair and partner products within customers' environments through continuous training, support, and consulting engagements. Each of our field sales professionals are supported by technical specialists with deep knowledge of our products and the broader product development domain. We believe this approach differentiates Altair from our competitors, as our focus on establishing a strong working relationship with the user community has led to expanded usage of Altair and partner products.

Our direct sales force is organized by geographic regions, consisting of Americas, EMEA, and APAC. As of June 30, 2017, we had over 900 field employees consisting of over 135 account managers, approximately 80 administrative support people, and over 700 application engineers and technical consultants in 68 offices in 24 countries.

### *Indirect sales channels*

More than 9% of our 2016 software revenue was generated through our growing network of indirect channel partners and resellers. These companies are central to Altair's software sales growth strategy by expanding our market reach to small and medium-sized customers. We ended 2016 with approximately 300 reseller and OEM relationships, including over 180 solidThinking resellers, primarily added in the last three years, and over 120 HyperWorks and Altair PBS resellers and OEMs. We are increasing our use of indirect channels in an effort to address a broader set of customers in consumer products, electronics, energy and other industries and expect the share of indirect channel sales to increase in the coming years.

To enable concept engineering driven by simulation we make our physics solvers more accessible to designers, who may be technical and not expert in simulation, by wrapping them in powerful, yet simple interfaces. In addition to being available under the HyperWorks suite, these products are sold through resellers worldwide under the solidThinking brand.

solidThinking is sold by over 180 resellers worldwide. The solidThinking resellers in the Americas and EMEA are managed by the solidThinking corporate team, while in APAC these resellers are managed by Altair field offices. This channel is relatively new and beginning to produce meaningful results.

We have OEM arrangements for Altair PBS Works with most of the major HPC hardware companies when they sell new computer systems. We believe these arrangements reduce competition, grow our market share and improve sales efficiency.

Carriots is sold and supported by resellers and implementation consultants in markets where they are strong and have vertical domain expertise outside of Altair's traditional manufacturing base. In addition to being available under HyperWorks, Carriots Analytics goes to market through OEM and strategic relationships worldwide including third party software companies seeking to embed analytics capabilities into their applications. We have established several key alliances in the utility and smart building controls markets.

## **Marketing**

Altair's global marketing team of approximately 65 people is focused on generating new business opportunities by driving awareness, deepening customer engagement, and developing content specific to technical fields and industry verticals. Our corporate marketing programs include social media, earned media, and publications

## [Table of Contents](#)

including Concept to Reality magazine, blogs, white papers and case studies. Our regional marketing program supports working relationships with our user community through education, participation in local industry events, Altair technical conferences, and webinars.

We provide marketing support to our ecosystem of resellers and third party technology partners on both a corporate and regional level.

In 2016 our online activities included:

- 230,000 resource library video views;
- 25,000 self-service training sessions;
- 18,500 webinar registrations;
- 30,000 software downloads;
- 1.9 million website visitors; and
- 63,000 social media followers.

Approximately 6,500 customers and prospects attended Altair's user conferences in 2016.

In order to continue to drive growth and extend our market position, we intend to continue to invest significant resources into our marketing initiatives.

## **Software products**

Altair's software products, available under our HyperWorks, solidThinking, Altair PBS, and Carriots suites, represent a comprehensive, open architecture CAE simulation platform. We believe our products offer the industry's broadest set of technologies to design and optimize high performance, efficient, and innovative products. Our products are categorized by:

- Solvers & Optimization;
- Modeling & Visualization;
- Industrial & Concept Design;
- IoT; and
- HPC.

### ***Solvers & optimization***

Solvers are mathematical software "engines" that use advanced computational algorithms to predict physical performance. Optimization leverages solvers to derive the most efficient solutions to meet desired complex multi-objective requirements.

Altair's solvers are a comprehensive set of fast, scalable and reliable physics solvers that can solve complex problems in linear and non-linear mechanics, fluid dynamics, electromagnetics, motion, systems and manufacturing simulation.

Altair's optimization technology is a key differentiator and spans our product offering. Our focus on optimization combined with multiphysics and multi-domain simulation has changed product development, and we believe customers using our technologies can gain a sustainable competitive advantage by developing better products in less time.

[Table of Contents](#)

**OptiStruct®** Our flagship solver for structural analysis simulation and optimization for linear and nonlinear events under static and dynamic loadings. Winner of Industry Week's Technology of the Year award in 1994, OptiStruct is widely used in industry for topology, shape, size, and composite material optimization.

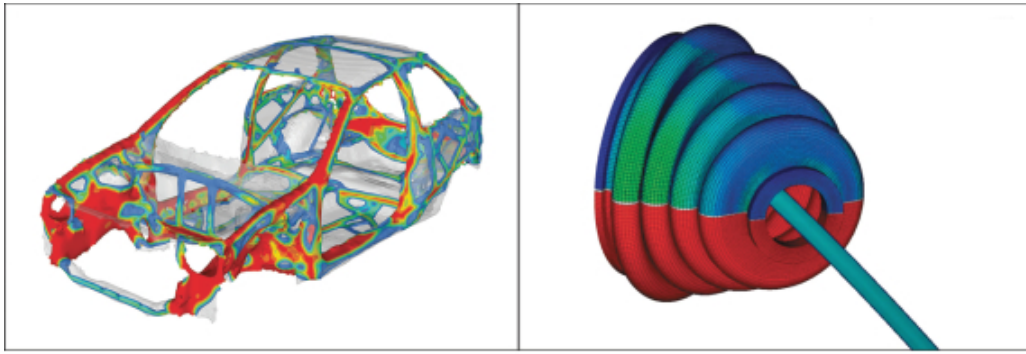

*Car frame designed with topology optimization to maximize performance and minimize weight*

*Nonlinear analysis of rubber shift boot to ensure durability*

**RADIOSS®** Crashworthiness, safety, and impact solver for non-linear problems under transient, dynamic loadings. RADIOSS is highly scalable, and contains multi-physics solution capabilities for the most complex mechanical events, including fluid-structure interaction, composite failure and crack propagation.

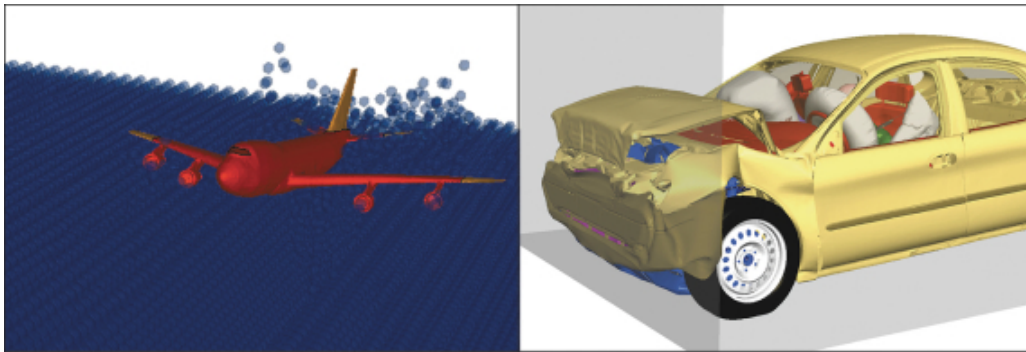

*Airplane ditching simulation demonstrating structural integrity through a water landing*

*Crash, safety, and impact simulation*

[Table of Contents](#)

**AcuSolve®** Computational Fluid Dynamics (CFD) solver with a full range of simulations including flow, heat transfer, turbulence, and non-Newtonian materials. Highly accurate and scalable solutions, even on fully unstructured meshes, provide fast and accurate solutions for both transient and steady-state solutions.

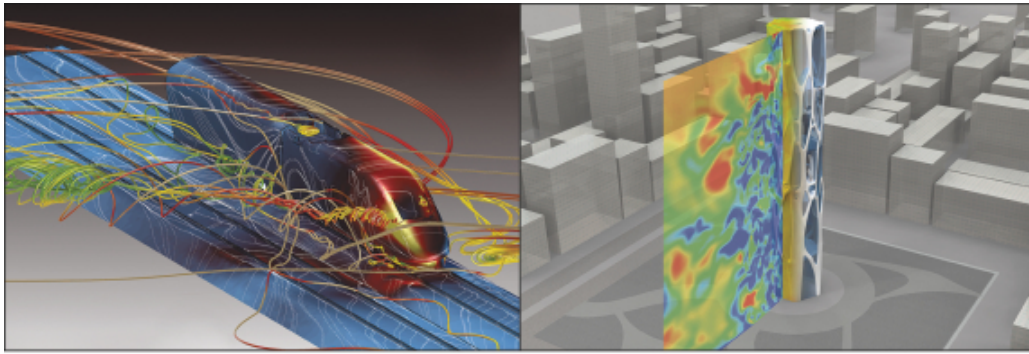

*Rail car pressure field and streamlines from drag-reduction simulation*

*Architectural aerodynamics*

**FEKO®** Comprehensive electromagnetics, or EM, solver used widely in telecommunications, automobile, space and defense industries. With a particular strength in the high frequency domain, FEKO uses multiple frequency and time domain techniques for efficient analysis of a broad spectrum of EM problems, and designed to solve problems such as antenna placement and investigation of electromagnetic compatibility.

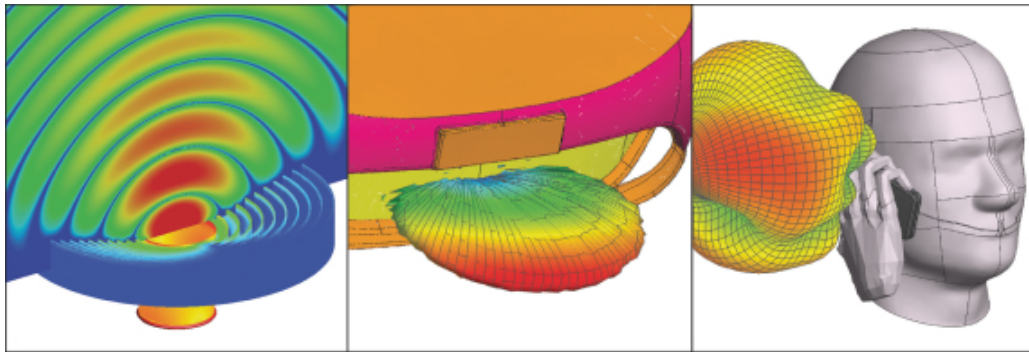

*EM simulation of corrugated horn antenna to ensure total system performance*

*Simulation to assist in the design of integrated vehicle radar*

*Quantification of radiation emission patterns from mobile device in proximity to a user*



[Table of Contents](#)

**Flux™** Finite element solver for low-frequency EM and thermal simulations, including those required for electric motor design. Flux features extended multiparametric analysis capabilities, and electrical circuit and kinematic couplings, with applications ranging from rotating machinery and linear actuators to induction heating processes.

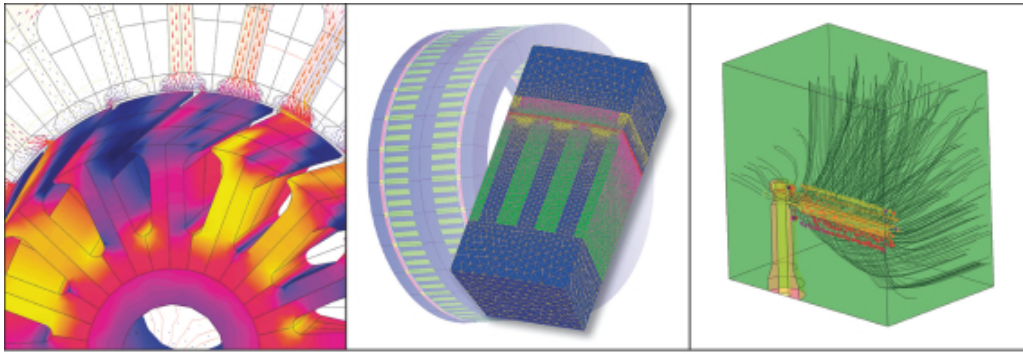

*Flux density simulation of an induction machine to optimize electric motor performance*

*Rotating machine model*

*Electric field lines on a conductor to analyze performance*

**WinProp™** Wave propagation and radio network planning suite, with applications ranging from satellite to terrestrial. Accurate with short computation times, WinProp's broad capabilities provide wireless planning guidance in rural/urban, indoor/outdoor, underground, moving vehicle and many other environments.

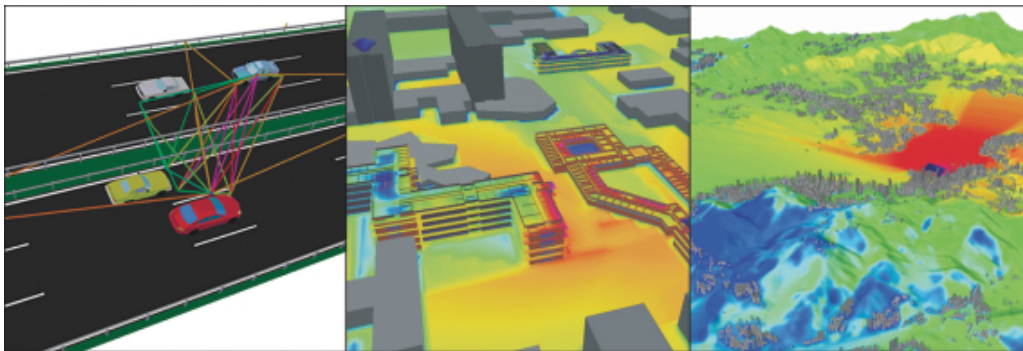

*Radio network propagation analysis for interconnected vehicles*

*Urban area multi-floor building wave propagation analysis*

*Network coverage analysis based on urban buildings and topography*

[Table of Contents](#)

**ESAComp™** Software for design and analysis of composites, ranging from conceptual and preliminary design of layered composite structures to advanced analyses for final design verification. The comprehensive material database in ESAComp underpins its capabilities for micromechanical and solid/sandwich laminate analyses. It also includes analysis tools for structural elements including flat and curved panels, stiffened panels, beams and columns, and bonded and mechanical joints. ESAComp’s capabilities for early design of composites are complementary to the composite capabilities of OptiStruct and Multiscale Designer.

**Multiscale Designer™** Design tool for simulating composite and other multi-scale materials. Applications include the modeling of continuous, woven, or chopped fiber composites, honeycomb cores, reinforced concrete, soil, bones, and various other heterogeneous materials.

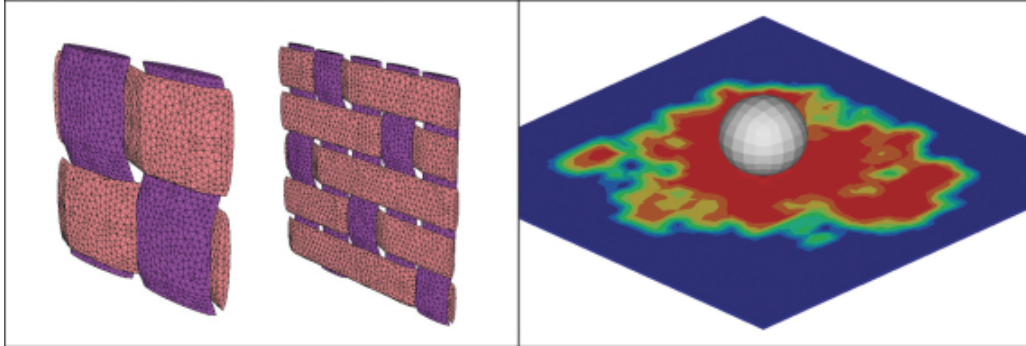

*Multiscale modeling of carbon fiber composites*

*Low velocity impact simulation of composite material*

**HyperStudy®** Design exploration and multi-disciplinary optimization software for improving product performance, quality and robustness. HyperStudy’s simple interface and powerful tools for design of experiments, approximation and optimization methods allow creation of intelligent design variants, manage simulation runs, and collect the data necessary to gain design insight and make product improvement decisions.



*Power tool cooling fan optimization*

*Bottle optimization for increased performance and reduced mass*

[Table of Contents](#)

**MotionSolve®** Multi-body systems solver for analyzing and optimizing mechanical system performance. MotionSolve solves the equations of motion using kinematic, dynamic, static, quasi-static, and other analysis methods for applications including vehicle suspension systems, aerial vehicle dynamics, robotics and general machinery mechanisms.

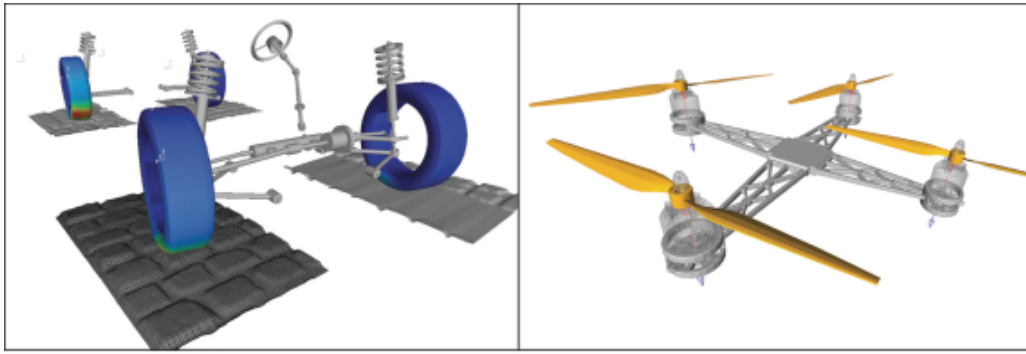

*Vehicle durability simulation*

*Unmanned Aerial Vehicle (UAV)  
performance analysis*

**Modeling & visualization**

Modeling & visualization tools allow for advanced physics attributes to be modeled and rendered on top of object geometry in high fidelity. These tools are becoming more design-centric and relevant earlier in the development process.

**HyperMesh®** A market leader in high-fidelity CAE modeling, able to handle large and complex models and manage the modeling process from import of CAD geometry to exporting a ready-to-run solver input file. HyperMesh provides engineers a highly interactive and visual environment, a complete set of meshing, assembly, and model setup tools, and a broad set of direct interfaces to third party commercial CAD and CAE systems.

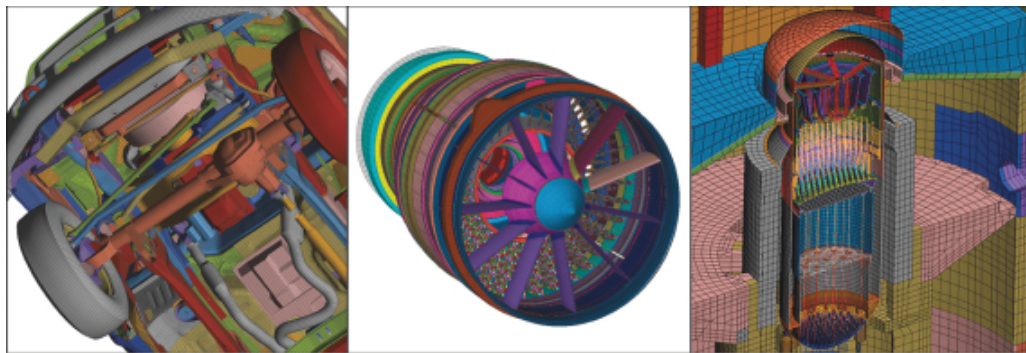

*Bottom view of a full car  
finite element mesh*

*Aerospace engine meshing*

*Highly complex finite element  
model for a nuclear reactor*

[Table of Contents](#)

**HyperView**® High-performance post-processing and visualization environment for CAE and test data. HyperView is a solution for visualizing, correlating and interrogating large models and sets of data from finite element analysis, multi-body system simulations, digital video, and engineering test data.

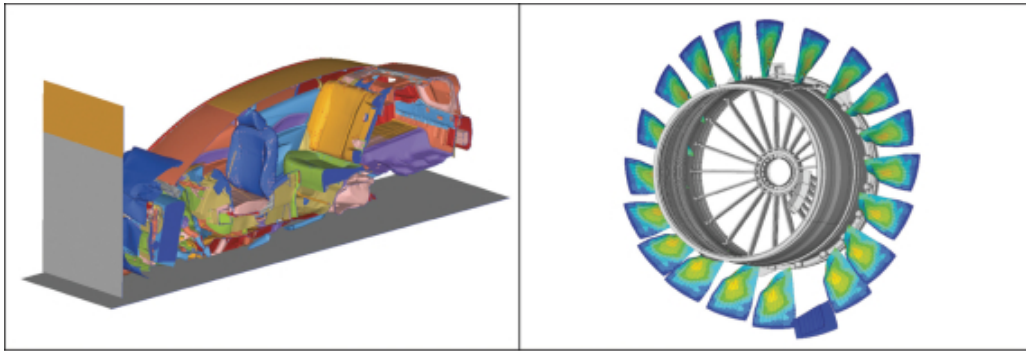

*Cross section cuts for crash simulation animation*

*Results visualization of turbine computational fluid dynamics analysis*

**SimLab**® Process oriented finite element modeling software especially suited for complex solid element modeling. SimLab uses process automation of simulation modeling tasks to reduce time spent and human errors in creating finite element models of complicated 3D assemblies such as automotive engines and braking systems.

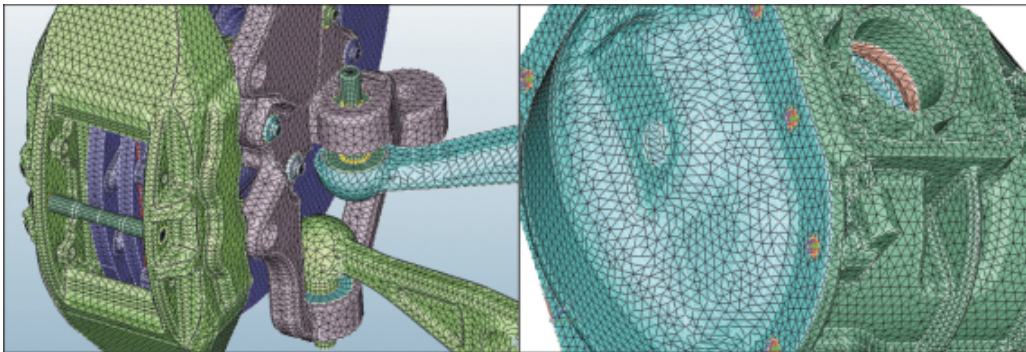

*Full system vehicle suspension finite element mesh*

*Meshed vehicle transmission housing*

[Table of Contents](#)

**HyperCrash®** Pre-processing technology for automotive crash analysis and safety simulation. HyperCrash provides safety engineers a dedicated virtual workflow to automate the creation of high-fidelity crash simulation models, including tools for dummy modeling and positioning, airbag folding and seat belt routing.

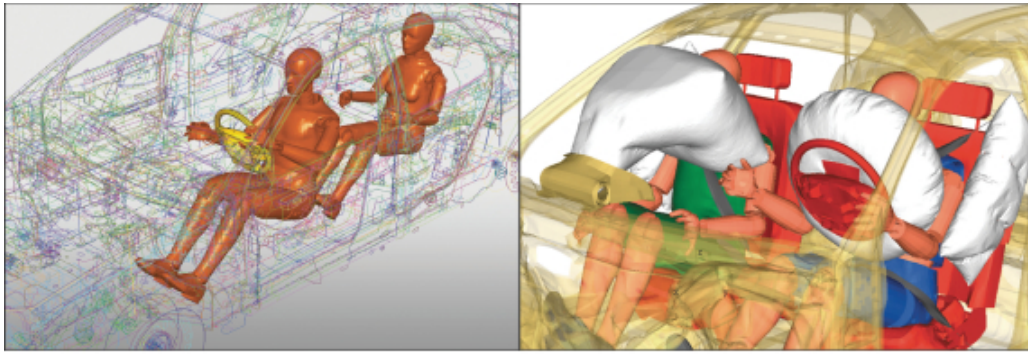

*High-fidelity human and vehicle models for crash analysis and safety evaluation*

*Dummy positioning and airbag folding performance*

**MotionView®** A multi-body systems modeling environment with parametric capabilities to build, analyze, and improve mechanical system designs. MotionView is designed as an end-to-end solution with an intuitive user interface, hierarchical, parametric and flexible-body modeling capabilities, and an open architecture for interfacing with MotionSolve or other third party motion and finite element simulation products.

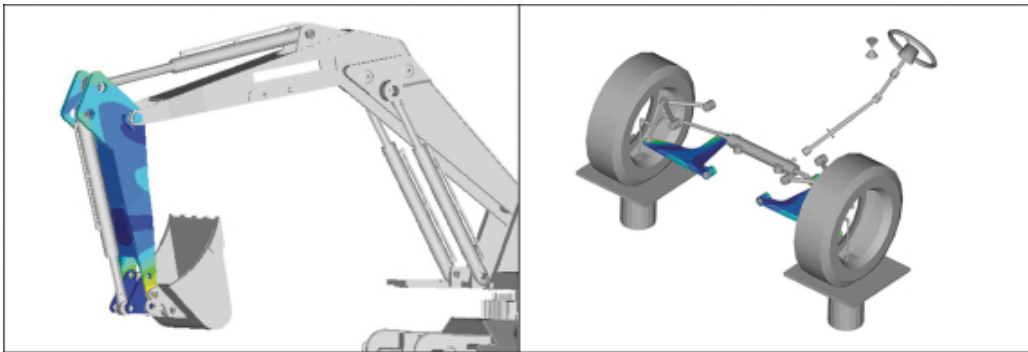

*Excavator arm flexbody simulation*

*Automotive front suspension simulation*

[Table of Contents](#)

**HyperGraph®** A data analysis and plotting tool with interfaces to many file formats. Plotting and analyzing data in an environment made for demanding scenarios, HyperGraph allows users to graph, visualize, and study massive data sets and process even the most complex mathematical expressions.

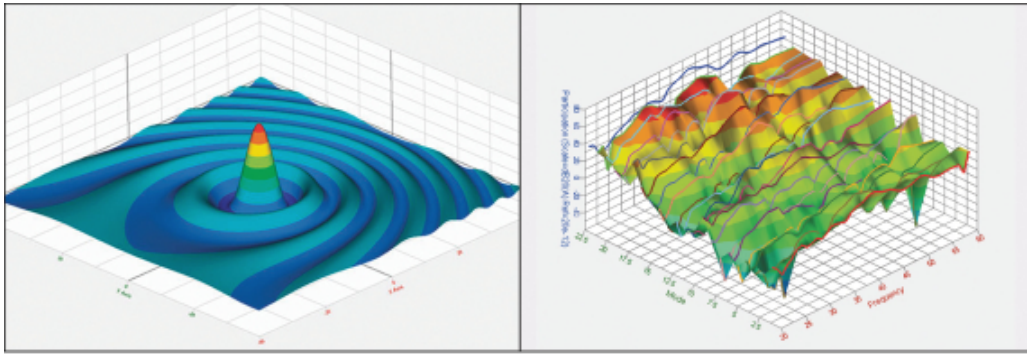

*Visualization of mathematical "raindrop" plot*

*Colormap plot for modal participation analysis*

**Industrial & concept design**

Industrial & concept design tools that generate early concepts to address requirements for ergonomics, aesthetics, performance, and manufacturing feasibility. These tools are simulation-driven and, we believe, emerging as a market force eclipsing traditional CAD.

**Inspire™** concept design software to generate and analyze design concepts using OptiStruct® technology. With a user experience tailored to design engineers, product designers, and architects, Inspire gets users to the right design, faster.

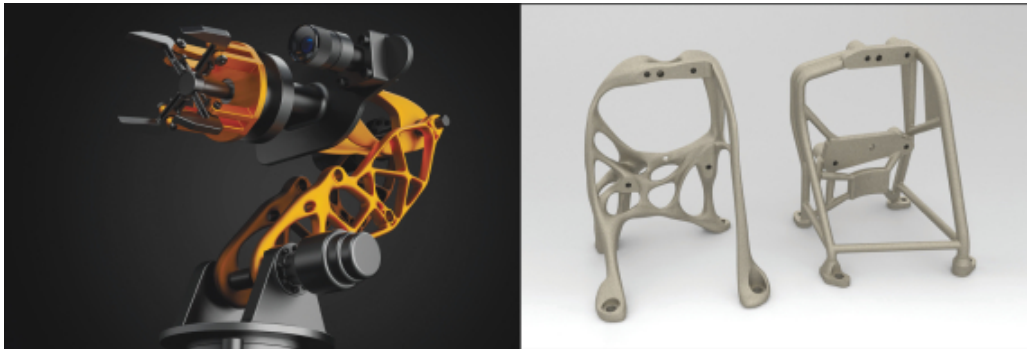

*Robot arm designed and optimized using Inspire*

*Optimized and 3D printed metal aerospace bracket*

[Table of Contents](#)

**Evolve™** An Industrial Design tool for fast form generation, manipulation and rendering. Evolve enables the capture of an initial sketch, exploration of styling alternatives, and visualization of products with realistic renderings generated in real time.

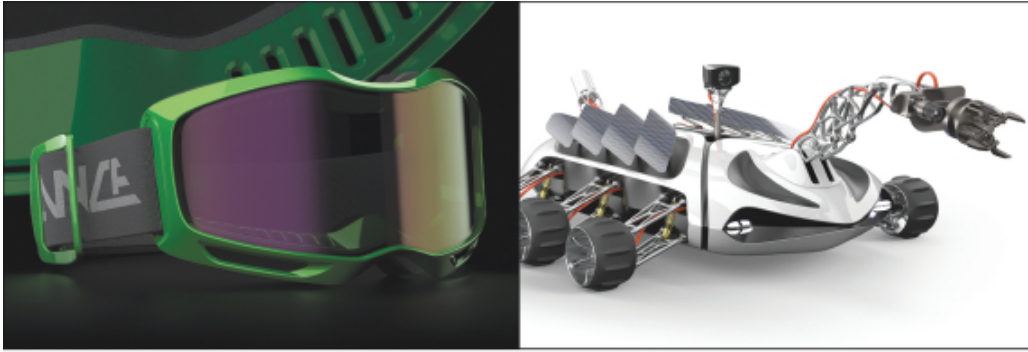

*Goggles concept design*

*Mars rover concept design*

**Thea Render™** A fast and versatile rendering software with unbiased, biased and GPU engines and its own advanced studio. Thea Render offers light simulation and a powerful material system using physically-based models for outstanding image quality.



*Digitally rendered conservatory  
by Massimo Siracusa*

*Digitally rendered watch  
by Patrick Nieborg*

[Table of Contents](#)

**Click2Cast®** Casting process simulation software for efficient mold design and process development. The five step interface in Click2Cast lets users identify and correct any filling and solidification issues early in the manufacturing process to avoid typical defects of air entrapment, shrinkage porosity and cold shuts.



*Complete casting process simulation in five steps*

*Fast and accurate casting defect prediction*

**Click2Extrude™** A metal and polymer extrusion simulation environment to validate and optimize extrusion die designs and processes. Click2Extrude helps extrusion companies produce complex profiles with tight tolerances, quality surface finishes, and high strength at reduced cost.

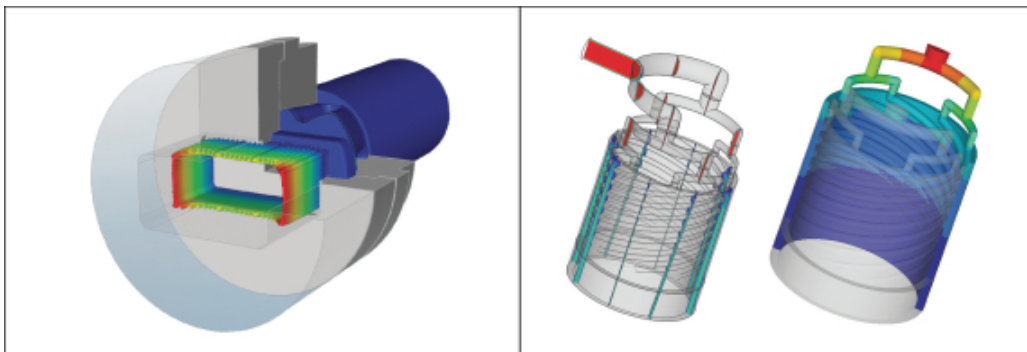

*Extrusion simulation to visualize, predict, and prevent defects*

*Velocity and pressure distribution in a spiral extrusion die*



## [Table of Contents](#)

**Click2Form™** An industry-proven sheet metal forming simulation tool to optimize development of stamped products. Click2Form offers a solution for managing the entire stamping simulation process, including robust modules for cost and feasibility, parametric die design, process validation, results visualization and die structure optimization.

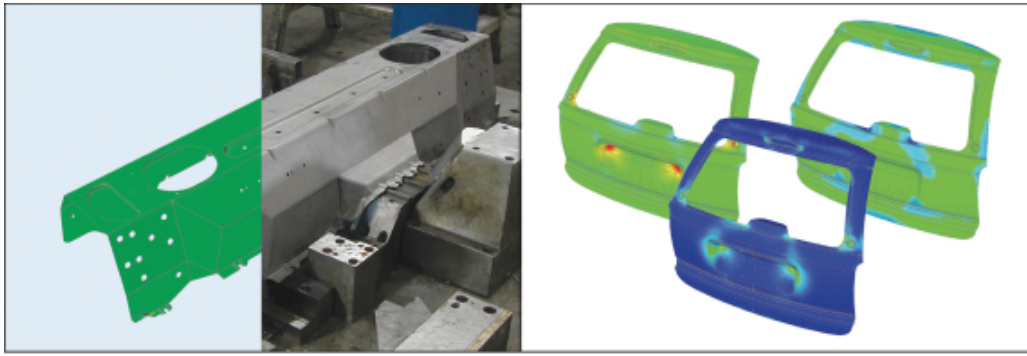

*Early stamping process feasibility*

*Stamping analysis visualization*

## **IoT**

Tools to develop new IoT enabled products, including device and data management, system level and full 3D digital twin simulation, and exploration, predictive analysis, optimization, and visualization of in-service performance. We expect our tools for multidisciplinary simulation and development to become increasingly important for product design. Our software is used to design and optimize IoT devices and connectivity, and for modeling in-service product performance.

We believe Altair's math and systems solutions are unique for their openness, usability, and ability to provide signal-based and physical modeling from "0D" to "3D" all within our units-based subscription licensing model. A truly simulation-driven design process means that simulation models support decision making in each stage of the product development process. To support this, models need to be multidisciplinary and may include mechanics, electrical and electronics, and software among other technical elements, and must encompass a scope of products ranging from components to IoT-enabled "systems of systems". Varying degrees of fidelity aid the process where computational requirements or data availability might otherwise prove to be obstacles.

We believe a key strength to Altair's math and systems solutions is allowing development organizations to move seamlessly in this multi-discipline, multi-component, multi-detail space while integrating models from various authoring tools. With a broad range of multi-physics solvers based on an open-system approach, a strong set of model reduction techniques can be employed toward IoT-enabled product development which can then be carried forward into device management and application development on the Carriots platform.

[Table of Contents](#)

**Carriots™** is an end-to-end and open architecture IoT platform that helps customers enable their products to communicate via numerous standard protocols, perform device and data management, visualize and analyze big data, develop applications, and perform digital twin simulations. It complements Altair's other product suites to provide a comprehensive solution for customers to design and implement IoT enabled products, optimize product performance and manufacturing throughput, predict failure, and schedule maintenance operations for in-service equipment. The solution is designed with Altair's open philosophy to facilitate seamless integration of its platform elements within customer enterprises to share data and communicate with multiple ERP, simulation and communication systems.

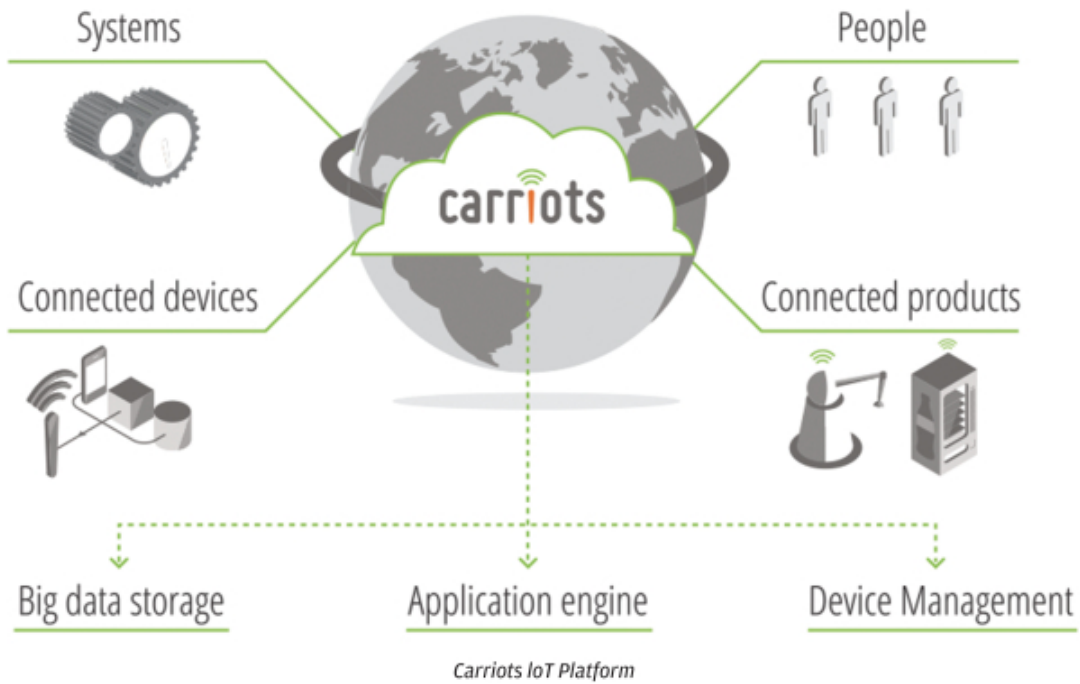

**Carriots Analytics™** Cloud-based analytics platform focused on IoT and big data for hosted and on-premises environments to simplify data visualization, exploration, and analysis. Architected for an optimized self-service user experience, Carriots Analytics speeds up data visualization, exploration and discovery.

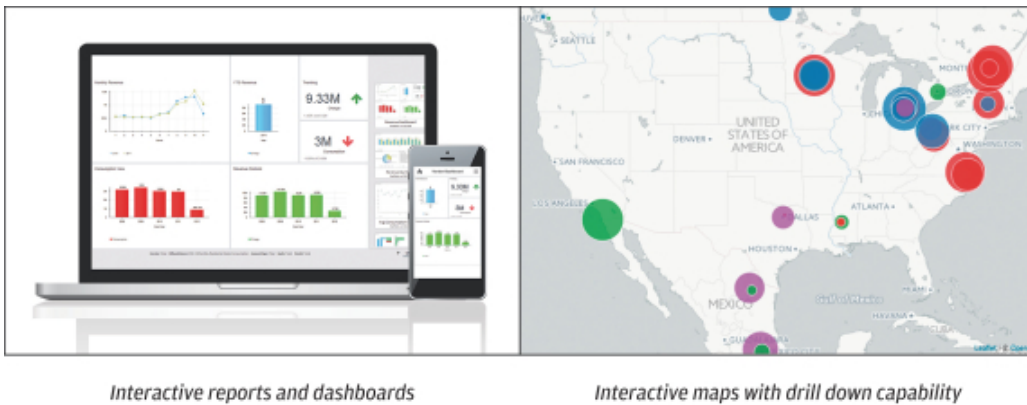

[Table of Contents](#)

**Modeliis™** Electronic Design Automation, or EDA, software for circuit modeling, system design and simulation geared towards the Internet of Things, or IoT, autonomous vehicles, and complex hybrid systems. The software simulates C-code behavior for various chips and include a very high-performance SPICE circuit simulator.

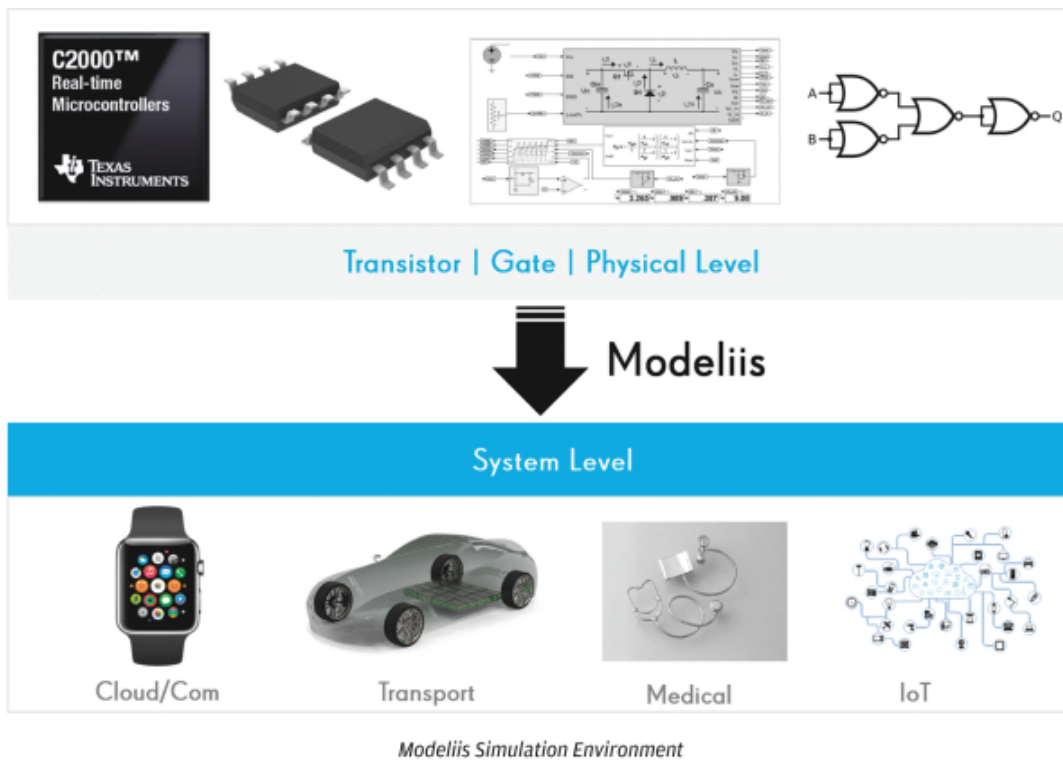

**Compose™** A numerical computing environment for science and engineering, including a high level matrix-based numerical computing language and an interactive and unified programming environment for all types of math operations. Engineers, scientists, and product creators can perform numerical computations, develop algorithms, perform signal analysis, design control systems, and analyze and visualize data in Compose.

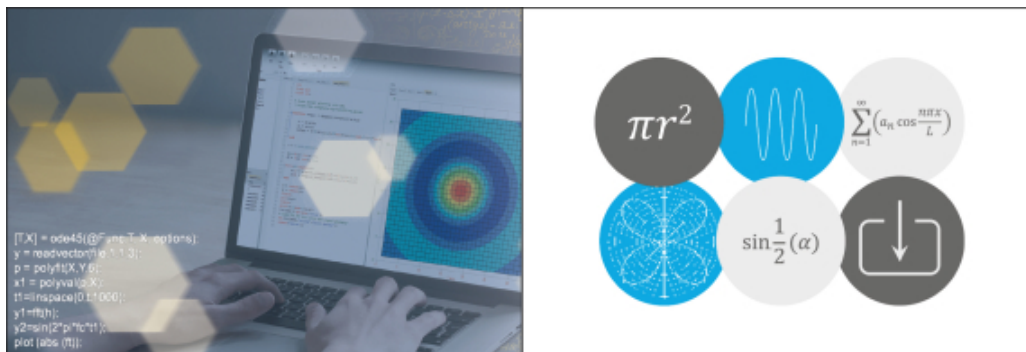

*A numerical computing environment for science and engineering*

*One environment for all types of math*

## Table of Contents

**Activate™** Model-based development of multidisciplinary systems incorporating functions of sensing, actuation, and control from diverse components. Activate's block diagram modeling environment empowers users to build demonstrations of how real world systems function and quickly explore new concepts without the need to build prototypes.

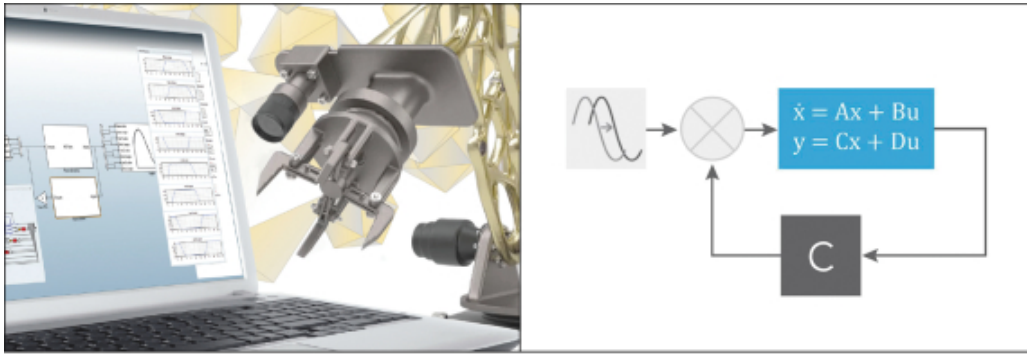

*Modeling, design, and optimization of multi-disciplinary systems*

*Block diagram for virtual and physical electromechanical system development*

**Embed™** A visual environment for model-based development of embedded control systems. Embed allows users to quickly develop virtual prototypes of dynamic systems. Embed features Software-in-the-Loop, Processor-in-the-Loop, and Hardware-in-the-Loop simulations, and automatically converts the control diagrams into C-code to be downloaded to the target hardware.

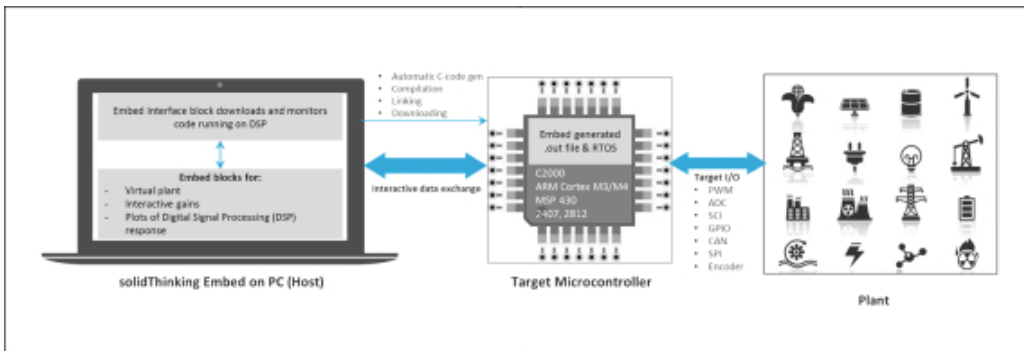

*solidThinking Embed on PC (Host)*

*Target Microcontroller*

*In-service Operation*

## High-performance computing

HPC software applications designed to streamline the workflow management of compute-intensive tasks including solvers, optimization, modeling, visualization and analytics in fields such as PLM, weather modeling, bio-informatics and electronic design analysis.

Altair's HPC offerings support engineers and scientists across a wide range of industries including automotive, aerospace, academia, energy, electronic design automation, defense, and weather. Altair PBS Works is our secure workload management suite to improve HPC performance and reliability in on-premise, cloud, and hybrid environments.

## [Table of Contents](#)

Our simulation technology users are moving to ever-larger models to achieve higher-fidelity results for more realistic simulations. As these models are computationally intensive, they require special equipment and cloud access for deeper design exploration and optimization. We believe HPC addresses the performance needs of our users and is critical to companies and research organizations working on complex, simulation-intensive design problems.

**Altair PBS Works™** HPC workload management suite designed to improve resource utilization and ROI with policy-based job scheduling, user-friendly portals for job submission and remote visualization, and deep analytics and reporting with the following suite highlights:

- **Altair® PBS Professional®** Workload management and job scheduling systems software available in both open source and commercial licensing.



*Compute Manager simplifies HPC for end users' job interactions*

*Workload management to optimize resource usage*

- **Altair PBS Cloud™** A platform to create, provision, manage, monitor, simulate and analyze HPC appliances on any cloud infrastructure (private, hybrid and public). It allows real-time monitoring for preventive maintenance in a single command center interface.

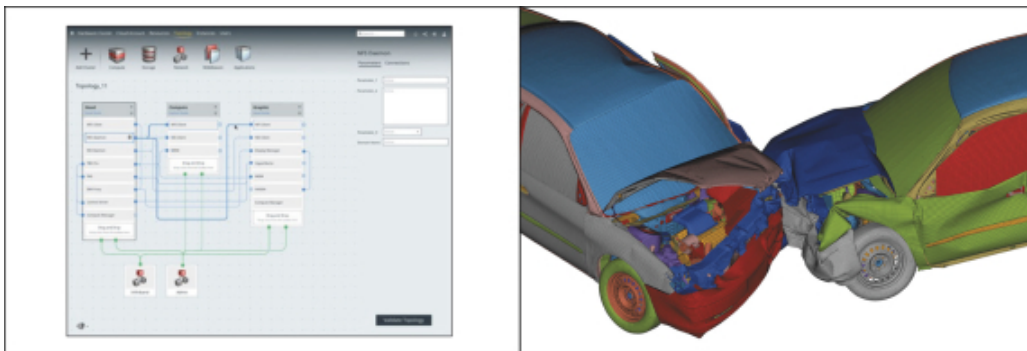

*Altair PBS Cloud interface*

*Crash simulation enabled by Altair PBS Cloud*

## [Table of Contents](#)

- **Altair PBS Access™** A portal for engineers and researchers to access, monitor and manage batch and interactive jobs, including remote 3D visualization on HPC resources.



*Altair PBS Access user interface*

- **Runtime** Runtime complements Altair's PBS Works suite of products for comprehensive, secure workload management for HPC and cloud environments and has solutions to manage highly complex workflows. We believe both Runtime and PBS Works deliver innovative and mission critical technology to optimize the use of HPC for compute-intensive applications. PBS Works targets product design, weather prediction, oil exploration and bio-informatics, and Runtime primarily serves customers in EDA.
- **NetworkComputer™** An enterprise grade job scheduler designed for distributed HPC environments. A highly adaptable solution, it is capable of managing compute infrastructures from small dedicated server farms to complex distributed HPC environments.
- **WorkloadXelerator™** A high-performance workload specific scheduler, WorkloadXelerator is architected to off-load the base scheduler, enabling greater throughput, better license and resource utilization, and more flexible scheduler usage models. WorkloadXelerator is designed to work with multiple third party schedulers.
- **FlowTracer™** An advanced platform for developing and executing flows. FlowTracer's "Runtime Tracing" technique analyzes flows, identifies dependencies and inherent parallelism built into today's complex flows optimizing use of compute resources. FlowTracer's powerful user interface provides users with flow visualization and troubleshooting capabilities for greater productivity.
- **LicenseAllocator™** Enables the sharing of software licenses among multiple job scheduling servers spread across multiple geographical sites and/or business units enabling increased software license utilization. We believe LicenseAllocator achieves maximized license utilization by following the fundamental rules of "following the demand", "gradual license migration", and "license sharing according to policies".
- **LicenseMonitor™** A software license-tracking tool providing current and historical software license utilization for multi-site environments. Software license availability and usage statistics are gathered and displayed in real-time via a rich graphical user interface. Current and historical usage data provides information for accurate planning and license cost optimization.
- **HERO™** Hardware Emulation Resource Optimizer Designed specifically for hardware emulation environments, HERO is an end-to-end solution. HERO seeks to address addresses all aspects of emulation

---

## [Table of Contents](#)

flow including: design compilation, emulator selection, and software and regressions tests. A vendor independent solution, HERO is capable of managing job-scheduling requirements of multiple EDA product families.

### ***Altair Partner Alliance***

The Altair Partner Alliance provides access to a broad spectrum of complementary software products using customers' existing HyperWorks Units. They can download and use partner product applications on-demand. This constantly growing portfolio extends their simulation and design capabilities to help create better products faster.

Software products in the APA include technologies ranging from computational fluid dynamics and fatigue to manufacturing process simulation and cost estimation, with applications specific to industry-verticals including marine, motorcycles, aerospace, chemicals, and architecture. Altair plans to continue to add valuable third party software solutions to the HyperWorks platform to empower innovation with comprehensive enterprise analytic tools.

We believe the Altair Partner Alliance is unique, because it:

- Allows customers access to non-Altair software with their existing HyperWorks Units;
- Provides customers an opportunity to reduce infrastructure and administrative costs;
- Gives customers the ability to quickly evaluate and deploy software on-demand;
- Provides partners who participate with a new channel for software distribution with shorter sales cycles due to established relationships and infrastructures; and
- Incorporates a new paradigm, where Altair shares software royalties with our partners based on actual customer usage reports.

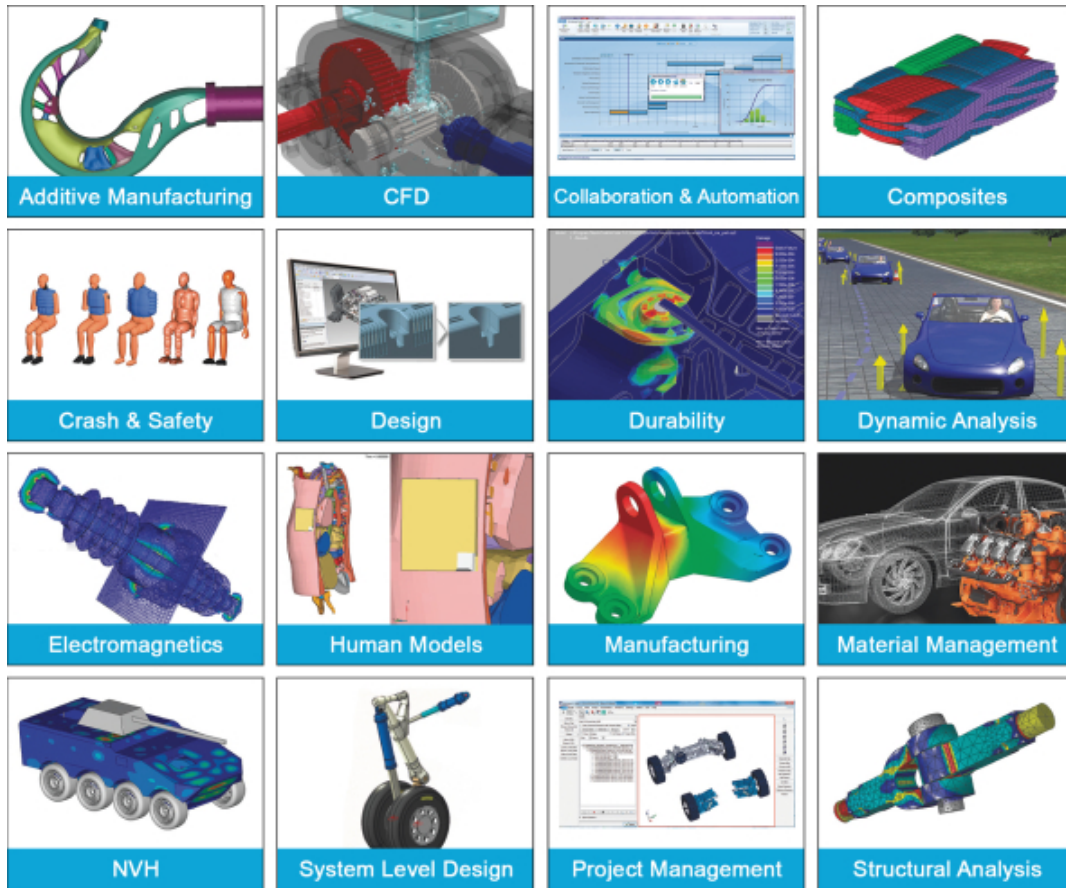

*Example of Altair Partner Alliance products*

### **Software related services**

To ensure customer success and deepen our relationships with them, we engage with our customers to provide services related to our software including consulting, training, and implementation services, especially when applying optimization. We provide clients with technical services throughout their entire product development lifecycle including design, engineering, and development. Altair's headquarters includes an industrial design studio, a prototype shop, and test facilities. We have expertise designing and working with controls, power electronics, traditional and composite structures, and total system level development in the automotive, aerospace, consumer products and other markets.

Implementation and custom software services are available to help customers leverage their investment in Altair's software to streamline CAE workflows and solve specialized industry vertical engineering problems. We work closely with our clients to increase organizational efficiency and decision making by tailoring these solutions to a client's own environment and processes.

We believe the unique combination of our broad industry domain knowledge and software expertise has enabled Altair to enhance and replace customers' legacy applications, integrate our software applications with client business systems, develop clean-sheet designs or custom software solutions, and transform their product development processes.



## **Client engineering services**

Altair provides Client Engineering Services, to support our customers with long-term ongoing product design and development expertise. This has the benefit of embedding us within customers, deepening our understanding of their processes, and allowing us to more quickly perceive trends in the overall market. Our presence at our customers' sites helps us to better tailor our software products' R&D and sales initiatives.

We operate our CES business by hiring engineers for placement at a customer site for specific customer-directed assignments. We employ and pay the engineers only for the duration of the placement.

We concentrate on placing simulation specialists, industrial designers, design engineers, materials experts, development and test engineers, manufacturing engineers and information technology specialists. As a leader in the simulation market, Altair attracts high caliber talent from around the world. CES is focused on placements that align strategically with customer usage of our software. We have a strong recruiting operation with over ten sourcing specialists who identify, attract, vet, and hire technical professionals for our in-house and customer needs. We maintain a candidate database of over 80,000 highly qualified engineers and designers. Our CES candidates and placed employees are valuable sources of talent acquisition for Altair's other business segments.

The average CES assignment was 1.8 years during the period from 2011-2016, with current average length of service for all CES employees at 2.4 years. As of December 31, 2016 44% of CES employees were in their assignments for over two years.

## **Research and development**

Our research and development efforts are focused on enhancing the functionality, breadth and scalability of our software, addressing new use cases, and developing additional innovative simulation technologies. Timely development of new products is essential to maintaining our competitive position, and we release new versions of our software on a regular basis.

Customer feedback, combined with our roadmap, enables us to deliver long-term value and stay ahead of market trends. The majority of product enhancements and new capabilities added to our platform over the years have been developed internally, with acquisitions used to augment our capabilities with strategic technology.

Our research and development initiatives foster a culture of innovation within the organization, helping us attract and retain a highly motivated team. Altair's research and development team consists of approximately 840 people worldwide. Most of our research and development team is based in Michigan and India; however, we also maintain research and development centers with specific technical expertise (for example, Stellenbosch, South Africa for electromagnetics).

Since Altair's first commercial software release in 1990, there have been over 35 new software products brought to market under the HyperWorks, solidThinking, and Altair PBS Works brands.

From time-to-time, we incubate related technologies developed by our employees. For example, as a result of an internal initiative, we developed and patented next-generation solid-state lighting technology. We commercialized this technology under our toggled subsidiary, which generated \$6.0 million in revenue in the twelve-month period ending December 31, 2016. WEYV, a mobile application that brings our patented units-based business model to digital content distribution and delivery, is expected to be released commercially.

Our research and development efforts relating to our software focus on five areas:

- **Solvers & Optimization:** Solvers are mathematical software “engines” that use advanced computational algorithms to simulate physics. Altair initially specialized in structural simulation, and now continuously develops our portfolio of solvers to simulate fluid dynamics, high and low frequency electromagnetics, mechanical systems, electronic controls and more. Altair also invests to “couple” our solvers to simulate multiple physics domains simultaneously, and is considered a world leader in the development of optimization technology, which drives solvers to find solutions to complex multi-objective design problems. R&D is also conducted to leverage high-performance computing technology for these compute intensive applications. Solver and optimization development is conducted by researchers with advanced degrees in engineering, physics, computer science and mathematics.
- **Modeling & Visualization:** The graphical applications used to construct and visualize simulation models require continuous R&D in the areas of data structures, computational methods, graphics, geometric modeling, mesh generation, and user interface design. Altair’s modeling tools are becoming more design-centric and are adopting some of the capabilities of traditional CAD while leveraging simulation and optimization technology to drive design decisions rather than just simulate designs. Specific areas of R&D include handling large scale models of highly detailed and complex products, developing new methods to derive design geometry from optimizations, and unifying the modeling environment for multi-physics simulation. Adapting modeling and visualization technology for cloud deployment is also an area of active development as is supporting virtual and augmented reality hardware.
- **Industrial & Concept Design:** Simulation-driven design requires tools to generate early concepts addressing requirements for ergonomics, aesthetics, performance, and manufacturing feasibility. These tools are simulation-driven, and we believe, emerging as a market force eclipsing traditional CAD. We believe Inspire is key to the democratization of simulation capabilities across large groups of designers and engineers who are not simulation specialists. Significant investment continues toward making the Inspire environment capable of providing most early design stage simulation needs. We expect to further integrate the visualization capabilities of Evolve and Thea Render across Altair’s product suites. The development teams for Industrial & Concept Design products include deep experience with industrial design processes and manufacturing methods.
- **IoT:** The Internet of Things requires tools to enable development of products that sense, collect, and communicate information. Our IoT toolsets perform device and data management, system level and full 3D digital twin simulation, and allow exploration, predictive analysis, optimization, and visualization of in-service performance. Carriots, including our cloud data analytics technology, makes our tools for multidisciplinary simulation and development increasingly important for product design and in-service operating data. Designed for visualizing and exploring large data sets, we are currently enhancing Carriots to facilitate deployment of analytics apps by third party developers and linked to IoT stacks.

Compose, Activate, and Embed support product development for the IoT through a math-based programming environment, multidisciplinary system modeling, and control system development and are an important ongoing research and development effort. We support our own high level matrix-based numerical computing language, as well as Python and Tcl, in an interactive programming environment for all types of math operations. We expect to add more language and library support, broaden the math libraries, and integrate these products more deeply with Altair’s other software.

- **HPC:** Altair’s acquisition and development of HPC software complements our compute intensive simulation and optimization technology. While investments continue in the core workload management technology, new areas of R&D include innovative workload simulation and resource optimization, a cloud-based user interface

## [Table of Contents](#)

to facilitate the deployment and administration of HPC clusters, and the development of new web-based job submission, monitoring and management tools. The HPC development teams work closely with the modeling and visualization teams and IoT Analytics teams to ensure that Altair's overall technology portfolio interoperates effectively and shares a common infrastructure and user experience.

In order to maintain and extend our technology leadership and competitive position, we intend to continue devoting significant effort to our research and development activities.

## Customers

As of December 31, 2016, we had tens of thousands of users across approximately 5,000 customers worldwide. Our customers are primarily large manufacturing enterprises. We have a growing presence in small and mid-size companies and compete in markets beyond manufacturing including Architecture/Engineering/Construction, or AEC, energy, life and earth sciences, and government entities. In 2016, we generated 38%, 32% and 30% of our total billings from customers in the Americas, APAC, and EMEA, respectively. None of our customers accounted for more than 10% of our 2016 billings. See the section entitled "Selected historical consolidated financial and other data—Key metrics."

Automotive and aerospace combined account for over 50% of our 2016 software billings, including 15 out of 15 of the world's leading automotive manufacturers and 10 out of 10 of the world's leading aerospace manufacturers. Other important industry segments include heavy machinery, rail and ship design, energy, government, life and earth sciences, and consumer electronics. No single customer, nor any of our approximately 300 resellers and OEMS, accounted for more than 3% of our 2016 software billings.

## Customer Case Studies

### **Robot Bike Company:** *Developing a Fully Customizable, Additively Manufactured Mountain Bike*

Robot Bike Company is a new startup established in the United Kingdom by aerospace engineers and mountain biking enthusiasts who identified the potential of combining additive manufacturing technologies with carbon fiber to, in their own words, "create the best bike frames possible." Robot Bike Company wanted to use additive manufacturing technologies to create a very high end mountain bike that could be built to order and tailored to an individual's weight, height and riding style, all within acceptable delivery timescales and manufacturing costs.

Weight is a concern for bike manufacturers as heavier bikes take more energy to move, a fact that is particularly notable for off-road bikes where the rider must power the bike over a wide variety of terrain, including steep inclines. When developing a bike however, the reduction of weight must not negatively impact the strength of the frame as this will have an obvious detrimental effect on the 'feel' of the bike, a difficult attribute to design for in engineering terms but a crucial one when riders come to a buying decision.

"Altair has assisted Robot Bike Co. to further reduce the weight of our frame whilst also ensuring that stresses are kept below a pre-determined maximum. This has allowed us to provide a life-time warranty and give our customers confidence that the product will be enduring", said a representative of Robot Bike Co.

### **Boeing:** *Altair PBS Professional at The Boeing Company: Workflow Management for R&D*

The Boeing Information Technology group provides a wide range of computing services to the entire corporation from its Bellevue, Washington computing campus. For the engineers who design Boeing commercial aircraft, the heartbeat of this campus is the Data Center, which houses the HPC systems that they access to run engineering simulations and analyses.

## [Table of Contents](#)

The HPC systems of the enterprise servers subgroup are accessed by all Boeing engineering departments, but the heaviest demand is from engineers running aerodynamics and structural models, particularly during the early stages of aircraft design. Most users log on from Boeing's four engineering and development locations around Puget Sound, but the servers are accessed by Boeing engineers in Philadelphia and other sites around the world.

"We rely on our batch scheduling system for adopting and managing queuing policies, and that's what Altair PBS Professional is all about. When we add clusters, we will continue to use more Altair PBS Professional", said a representative of Boeing.

### **University of Stellenbosch:** *The SKA Radio Telescope: a Global Project for a Better Understanding of the Universe*

Challenging Einstein's seminal theory of relativity to the limits, how the very first stars and galaxies formed just after the Big Bang, the study of dark energy and the vast magnetic fields in the cosmos, and the age old question "Are we alone in the Universe?" These are some of the key scientific goals of the Square Kilometer Array, or SKA, project, led by the SKA Organization from Jodrell Bank Observatory in the United Kingdom, supported by 11 member countries—South Africa, Australia, Canada, China, Germany, India, Italy, New Zealand, Sweden, The Netherlands and the United Kingdom.

The SKA will be a collection of various types of antennas, ranging from large dish reflectors to aperture antennas. Spread over large distances, they work together as an interferometric array to provide higher resolution images of astronomical objects. When completed, the SKA will be 10,000 times faster and 50 times more sensitive than any existing radio telescope. It will be constructed in two phases: Phase 1 (SKA1) is estimated to be completed in 2023 and is being built in South Africa and Australia; Phase 2 (SKA2) will be started after SKA1 and will take the project into other African countries, with the Australian component also being expanded. For Phase 1 the 64-dish MeerKAT precursor array, which is currently under construction and expected to come online in a few years' time, will be integrated into SKA1 MID, with the construction of another 190 dishes.

"FEKO modelling on the Cape Town CHPC has been pivotal in our RFI mitigation research. We have successfully validated dish scale models with measurement and continue to use FEKO to study EM induced current paths and provide RFI mitigation recommendations to SKA South Africa." said a representative of University of Stellenbosch, South Africa.

### **Philips:** *Personal Care / Personal Health*

Royal Philips, Founded in 1891 in The Netherlands, is one of the largest electronics companies in the world employing over 105,000 individuals in over 100 countries. It is a leading health technology company with a keen focus on improving people's health. This spans from healthy living, to diagnosis, treatment, and home care. Philips puts strong emphasis on leveraging the latest in technology, design, and deep consumer insights when developing each of the products in its broad portfolio. The company is a leader in diagnostic imaging, image-guided therapy, patient monitoring and health informatics, as well as consumer health and home care.

"As a designer, we are always under pressure to deliver results in a short period of time. Evolve has been a big advantage for me over other conceptual CAD packages," said a Philips representative.

## **Competition**

The market for CAE software is highly fragmented but has been undergoing significant consolidation. Our primary competitors include Dassault Systèmes, Siemens, Ansys and MSC Software. Dassault and Siemens are large public companies, with significant financial resources, which have historically focused on CAD and product

data management. More recently, these two companies have been investing in simulation software via acquisitions. Ansys and MSC are focused on CAE. In addition to these competitors, we compete with many smaller companies offering CAE software applications.

We believe the breadth and depth of Altair's software offering is unique in the PLM industry. We also believe no single competitor addresses our entire solution set. Our integrated suite of software optimizes design performance across multiple disciplines encompassing structures (including crashworthiness and safety), motion, fluids, thermal management, electromagnetics, system modeling and embedded systems, while also providing data analytics and true-to-life visualization and rendering. The HyperWorks Units model further extends this advantage with a growing APA marketplace of third party software.

Our simulation solutions including modeling, visualization and solvers are noted in the market for their ability to handle large and complex models. Our software applications deliver high-performance and high scalability, including massive parallelization, which is extremely important in the CAE market. Altair is a leader in integrating optimization technology across all our products including multi-disciplinary applications.

To ensure customer success and deepen our relationships with them, we engage with our customers to provide consulting, implementation services, training, and support, especially when applying optimization. We believe these services, combined with our ability to leverage HPC as the industry transitions to cloud computing, positions us for future success.

We compete on a variety of factors including the breadth, depth, performance, and quality of our technical solutions. We believe our patented units-based subscription licensing model provides us with a competitive advantage by lowering barriers to adoption, creating broad engagement, and encouraging users to work within our ecosystem.

## **Intellectual property**

We believe that our intellectual property rights are valuable and important to our business. We actively protect our investment in technology through establishment and enforcement of intellectual property rights. We protect our intellectual property through a combination of patent, copyright, trademark and trade secret protections, confidentiality procedures, and contractual provisions. The nature and extent of legal protection associated with each such intellectual property right depends on, among other things, the type of intellectual property right and the given jurisdiction in which such right arises.

As of December 31, 2016, we, inclusive of our wholly-owned subsidiaries, have 136 issued patents and more than 20 published patent applications worldwide. These patents and patent applications seek to protect proprietary inventions relevant to our business. We intend to pursue additional patent protection to the extent we believe it would be beneficial and cost effective. Additionally we are the registered holder of a variety of trademarks and domain names that include "Altair" and similar variations.

Nonetheless, our intellectual property rights may not be successfully asserted in the future or may be invalidated, circumvented or challenged. In addition, the laws and enforcement of the laws of various countries where our products are distributed do not protect our intellectual property rights to the same extent as United States laws. Our inability to assert or enforce our intellectual property rights could harm our business.

From time to time, we receive claims alleging infringement of a third party's intellectual property rights, including patents. Disputes involving our intellectual property rights or those of another party have in the past and may in the future lead to, among other things, costly litigation, diversion of time, money and resources to develop or obtain non-infringing products, or delay product distribution. Any significant impairment of our core intellectual property rights could harm our business or our ability to compete.

## [Table of Contents](#)

Our products are licensed to users pursuant to signed license agreements or 'click through' agreements containing restrictions on use, duplication, disclosure, and transfer. Cloud based products and associated services are provided to users pursuant to online or signed terms of service agreements containing appropriate restrictions on access and use.

We are unable to measure the full extent to which piracy of our software products exists. We believe, however, that software piracy is and can be expected to be a persistent problem that negatively impacts our revenue and financial results. We believe that our predominant subscription based business model combined with the change from desktop to cloud based computing will shift the incentives and means by which software is pirated.

In addition, through various licensing arrangements, we receive certain rights to intellectual property of others. We expect to maintain current licensing arrangements and to secure additional licensing arrangements in the future, as needed and to the extent available on reasonable terms and conditions, to support continued development and sales of our products and services. Some of these licensing arrangements require or may require royalty payments and other licensing fees. The amount of these payments and fees may depend on various factors, including but not limited to: the structure of royalty payments, offsetting considerations, if any, and the degree of use of the licensed technology.

## **Employees**

We have over 2,000 in-house employees and over 400 on-site Client Engineering Service employees globally. Over two-thirds of our employees are located in the United States, India, France, Germany and China. None of our employees in the United States are represented by a labor organization or are party to any collective bargaining arrangement. In certain of the European countries in which we operate, we are subject to, and comply with, local labor law requirements in relation to the establishment of works councils. We are often required to consult and seek the consent or advice of these works councils. We have never experienced a work stoppage and we believe our employee relations are good.

## **Facilities**

Our corporate headquarters are located in Troy, Michigan. We own our corporate headquarters facility consisting of 132,900 square feet of office space. In addition, we maintain 16 domestic offices some of which are subject to master leases or subleases with multiyear lease terms in Alabama, California, Massachusetts, New York, Texas, Virginia, Washington, and Wisconsin. We maintain offices in Arizona and North Carolina which are leased under annual lease terms.

In 2016, we acquired an undeveloped parcel of land adjacent to our headquarters, which we expect to develop over the next few years. In 2010, we acquired 136,000 square feet of industrial space in Troy, Michigan that is now used as the headquarters of our wholly-owned subsidiary toggled.

We maintain 52 international offices in Australia, Austria, Brazil, Canada, China, Finland, France, Germany, Greece, India, Israel, Italy, Japan, Malaysia, Mexico, South Africa, South Korea, Spain, Sweden, Taiwan, the United Kingdom and Vietnam. We lease all of our international facilities and do not own any real property outside of the United States. We expect to add facilities as we grow our employee base and expand geographically. We believe that our facilities are adequate to meet our needs for the immediate future, and that, should it be needed, suitable additional space will be available to accommodate expansion of our operations.

## Legal and regulatory

### *Legal proceedings*

From time to time, we may be subject to legal proceedings and claims in the ordinary course of business. We have received, and may in the future continue to receive, claims from third parties asserting, among other things, infringement of their intellectual property rights. Future litigation may be necessary to defend ourselves, our partners and our customers by determining the scope, enforceability and validity of third party proprietary rights, or to establish and enforce our proprietary rights. The results of any current or future litigation cannot be predicted with certainty and regardless of the outcome, litigation can have an adverse impact on us because of defense and settlement costs, diversion of management resources and other factors.

### *Litigation*

On July 5, 2007, MSC Software Corporation, or MSC, filed a lawsuit against us and certain of our named employees in the United States District Court for the Eastern District of Michigan, asserting, among other things, that we and certain of our employees misappropriated alleged trade secrets that certain of our employees breached contractual non-solicitation and confidentiality obligations owed to MSC and that we tortiously interfered with MSC's contractual relations with these employees. In April 2014, a jury returned a \$26.1 million verdict against us on three trade secrets claims and a tortious interference claim as well as against certain of our employees for breach of contractual obligations to MSC. In November 2014, this verdict was partially vacated except for damages of \$425,000 related to the employment matters, and the Court ordered a new trial on damages for the trade secrets claims. No trial date is scheduled. On August 21, 2017, the court granted Altair's motion to strike the testimony of MSC's damage expert. The court has not provided guidance on how the case will proceed. We cannot be certain of the outcome of this matter.

We can express no opinion regarding the ultimate resolution of this matter. Litigation is inherently uncertain, and any judgment or injunctive relief entered against us or any adverse settlement could negatively affect our business, results of operations and financial condition.

# Management

## Executive officers and directors

The following table sets forth information regarding our executive officers and directors as of September 25, 2017.

Name	Age	Position
<b>Executive Officers and Directors:</b>		
James R. Scapa	60	Chairman, Chief Executive Officer and Director
Brett Chouinard	52	President
Howard N. Morof	57	Chief Financial Officer
Massimo Fariello	55	Chief Strategy Officer
James P. Dagg	51	Chief Technical Officer, Modeling/Visualization
Dr. Uwe Schramm	59	Chief Technical Officer, Solvers/Optimization
Srikanth Mahalingam	46	Chief Technical Officer, HPC/Cloud Solutions
Jeffrey M. Brennan	51	Chief Marketing Officer
Martin Nichols	54	Chief Information Officer
Tom M. Perring	68	Chief Administrative Officer
Nelson Dias	50	Chief Revenue Officer
James E. Brancheau	66	Director
<b>Non-Employee Directors</b>		
Steve Earhart <sup>(1)(2)</sup>	69	Director
Jan Kowal <sup>(1)(2)(3)</sup>	64	Director
Trace Harris <sup>(2)(3)</sup>	52	Director
Richard Hart <sup>(1)(3)</sup>	53	Director

(1) Member of our audit committee

(2) Member of our compensation committee

(3) Member of our nominating and corporate governance committee

### Executive officers and directors

**James R. Scapa** co-founded our company and has served as Chairman of our board of directors and our chief executive officer since 1992. Prior to his role as our chief executive officer, Mr. Scapa served as secretary and treasurer since our inception in 1985. Mr. Scapa holds a bachelor's degree in mechanical engineering from Columbia University and a masters of business administration from the University of Michigan. We believe that the perspective and experience that Mr. Scapa brings as our chief executive officer and founder uniquely qualifies him to serve as the Chairman of our board of directors.

**Brett Chouinard** was recently named President, effective January 1, 2018, after serving as our chief operating officer since January 2010. Prior to his role as our chief operating officer, Mr. Chouinard served in various roles



## [Table of Contents](#)

with us since 1994. Prior to joining us, Mr. Chouinard worked as an engineer at GE Aircraft, a subsidiary of General Electric, Inc. specializing in aircraft engines. Mr. Chouinard holds a bachelor's degree in mechanical engineering from Michigan Technological University and a master's degree in mechanical engineering from the University of Cincinnati.

**Howard N. Morof** has served as our chief financial officer since February 2013. Mr. Morof also served as a member of our board of directors from February 2011 to February 2013. Prior to joining us, Mr. Morof served as chief financial officer of North American Bancard, LLC, an independent merchant and credit card processing company, from February 2008 to February 2013. Mr. Morof is a certified public accountant and holds a master's degree in taxation from Walsh College and a bachelor's degree in business administration from the University of Michigan.

**Massimo Fariello** has served as our chief strategy officer since January 2015. Prior to this role, Mr. Fariello served as our senior vice president of corporate development from April 2013 to December 2014 and prior to that, as our senior vice president of software technology alliances and strategies from July 2011 to March 2013. Mr. Fariello received his master's degree in automotive engineering from the Polytechnic University of Turin, Italy.

**James P. Dagg** has served as our chief technical officer of modeling and visualization since January 2014. Prior to this role, Mr. Dagg served as the vice president from May 2008 to December 2013 of our wholly-owned subsidiary solidThinking, Inc. Mr. Dagg holds a bachelor's degree in mechanical engineering and a master's degree in applied mechanics from the University of Michigan.

**Dr. Uwe Schramm** has served as our chief technical officer of solvers and optimization since January 2014. Prior to this role, Dr. Schramm served as managing director of Altair GmbH, our wholly-owned German subsidiary, from September 2011 to December 2013. Dr. Schramm holds a master's degree and a doctorate degree in solid mechanics from the University of Rostock in Rostock, Germany.

**Srikanth Mahalingam** has served as our chief technical officer for HPC and cloud solutions since January 2014. Prior to this role, Mr. Mahalingam was a senior vice president at Altair from July 2011 to November 2013 and a vice president from January 2008 to June 2011 at Altair. Mr. Mahalingam holds a bachelor's degree in computer science and engineering from Gulbarga University in Gulbarga, India and an executive masters of business administration from the Indian School of Business in Hyderabad, India.

**Jeffrey M. Brennan** has served as our chief marketing officer since January 2010. Prior to this role, Mr. Brennan served as vice president of the HyperWorks business unit from January 2002 to January 2010. Mr. Brennan joined the Company in June 1, 1992 as an engineering consultant. Mr. Brennan holds a bachelor's degree in mechanical engineering from the University of Notre Dame and a master's degree in mechanical engineering from the University of Michigan.

**Martin Nichols** has served as our chief information officer since July 2011. Prior to this role, Mr. Nichols served as our executive vice president of global alliances and operations from January 2010 to June 2011. Mr. Nichols joined the Company in July 1992 as a technical support engineer. Mr. Nichols holds a bachelor's degree in mechanical engineering from the University of Michigan.

**Tom M. Perring** has served as our chief administrative officer since July 2011. Prior to this role, Mr. Perring served as our chief financial officer from January 2000 to April 2007 and January 2010 to July 2011. Mr. Perring joined Altair in 1993 as an account manager. Mr. Perring holds a bachelor's degree and master's degree in physics from Oakland University in Rochester, Michigan and a master of business administration degree from the University of Michigan.

## [Table of Contents](#)

**Nelson Dias** was recently named Chief Revenue Officer, effective January 1, 2018, after serving as our Senior VP—Asia Pacific since 2006. Prior to running Altair's APAC region, Mr. Dias was Managing Director of Altair India from 2002-2005. He has over 28 years of technical sales and management experience. Mr. Dias holds a Bachelor of Engineering in Computer Science from the University of Mumbai.

**James E. Brancheau** has served as a member of our board of directors since October 2004 and was a member of our compensation committee from January to December 2016. Mr. Brancheau also serves as a member of the board of our wholly-owned subsidiary, Altair Engineering Ltd. (Japan), since February 2010. Mr. Brancheau has been providing engineering services to us on a part-time basis since January 2014. Mr. Brancheau previously served as our chief technical officer from January 2005 to December 2013, when he assumed a consulting role for the Company. Mr. Brancheau joined us in 1988 as a consultant. Mr. Brancheau holds a bachelor's degree in mechanical engineering from the University of Detroit. We believe Mr. Brancheau is qualified to serve as a member of our board of directors because of his more than 40 years of experience in engineering, software development and technical management. Mr. Brancheau has a deep understanding of the technology, culture and operations of the Company.

### **Non-employee directors**

**Steve Earhart** has served as a member of our board of directors since May 2011. Mr. Earhart is the chair of our audit committee, a position he has held since January 2016, and a member of our compensation committee, a position he has held since January 2015. Mr. Earhart served as chief financial officer of World Kitchen, LLC, a branded consumer products company, from April 2012 to January 2017. From December 2007 to June 2010, Mr. Earhart served as executive vice president and chief financial officer of Torex Retail Holdings, Ltd., a retail software provider based in the United Kingdom. Mr. Earhart is a certified public accountant and holds a bachelor's degree in business and accounting from the University of Illinois and master's degree in business administration from the University of Wisconsin. We believe Mr. Earhart is qualified to serve on our board of directors because of his significant corporate finance, operational and business experience gained from holding senior executive positions at both publicly-traded and private technology and consumer companies.

**Jan Kowal** has served as a member of our board of directors since July 2013. Mr. Kowal is a member of our compensation committee, a role he has held since January 2016, our audit committee, a role he has held since January 2017 and a member of our nominating and corporate governance committee, a position he has held since April, 2017. Mr. Kowal served as a consultant to Brose Fahrzeugteile GmbH & Co., an international automotive parts supplier based in Germany, and its affiliates in the United States and Europe from May 2015 to May 2017. Mr. Kowal served as the chairman of Brose Fahrzeugteile's American subsidiary Brose North America, Inc. from August 2012 to May 2015 and as its president and chief executive officer prior to that. Mr. Kowal served on the board of directors of Original Equipment Supplier Association from 2008 to 2013 and served as the chairman of the board in 2012. Mr. Kowal holds a master's degree in mechanical engineering from Chalmers University of Technology in Goteborg, Sweden. We believe Mr. Kowal is qualified to serve on our board of directors because of his substantial international business experience and deep familiarity with the automotive industry.

**Trace Harris** has served as a member of our board of directors since August 2016. Ms. Harris is the chair of our compensation committee a role she has held since January 2017 and a member of our nominating and corporate governance committee, a role she has held since April 2017. Ms. Harris currently serves as the chief financial officer of A-List Services, LLC, an educational services provider, a position she has held since January 2017. From December 2014 to December 2016, Ms. Harris was a principal at T-Harris LLC, a media and education consulting firm. Prior to that, Ms. Harris spent 13 years, from September 2001 to November 2014, working in various roles at Vivendi S.A., most recently serving as senior vice president, strategy, finance and business innovation. Ms. Harris holds a bachelor's degree in economics from Stanford University and a master's

degree in business administration with a concentration in finance from the Yale School of Management. We believe Ms. Harris is qualified to serve on our board of directors because of her significant corporate finance, operational and business experience.

**Richard Hart** has served as a member of our board of directors since April 2017. Mr. Hart is the chair of our corporate governance committee, and a member of our audit committee, roles he has held since April 2017. Mr. Hart currently serves as the chief financial officer of Guidewire Software, Inc., a publicly-traded software publishing company, a position he has held since March 2015. Mr. Hart also serves as a member of the board of directors of Wonolo, Inc., a private on-demand labor and workforce staffing platform business, a position he has held since February 2016. Mr. Hart was a managing director at Deutsche Bank from May 2004 through November 2013. Mr. Hart holds a bachelor's degree in physics from the University of Pennsylvania and a juris doctorate degree from the New York University School of Law. We believe Mr. Hart is qualified to serve on our board of directors because of his significant corporate finance, legal and business experience.

## Selection of officers

Our executive officers serve at the discretion of our board of directors. There are no familial relationships among our directors and executive officers.

## Board composition

Our board of directors currently consists of six members. Our Delaware certificate of incorporation and Delaware bylaws provide for a classified board of directors, with each director serving a staggered, three-year term. As a result, only one class of directors will be elected at each annual meeting of our stockholders, with the other classes continuing for the remainder of their respective three-year terms. The terms of the directors will expire upon the election and qualification of successor directors at the annual meeting of stockholders to be held during 2018 for the Class I directors, 2019 for the Class II directors and 2020 for the Class III directors. Our directors will be divided among the three classes as follows:

- the Class I directors will be James Brancheau and Jan Kowal and their terms will expire at the annual meeting of stockholders to be held in 2018;
- the Class II directors will be Richard Hart and Trace Harris and their terms will expire at the annual meeting of stockholders to be held in 2019; and
- the Class III directors will be James R. Scapa and Steve Earhart and their term will expire at the annual meeting of stockholders to be held in 2020.

Upon expiration of the term of a class of directors, directors for that class will be elected for three-year terms at the annual meeting of stockholders in the year in which that term expires. Each director's term shall continue until the election and qualification of his or her successor, or the director's earlier death, resignation or removal. Any additional directorships resulting from an increase in the number of authorized directors will be distributed among the three classes so that, as nearly as possible, each class will consist of one-third of the directors.

The division of our board of directors into three classes with staggered three-year terms may delay or prevent a change of our management or a change of control. Under Delaware law and our Delaware certificate of incorporation, for so long as our board of directors is divided into classes, our directors may be removed for cause by the affirmative vote of the holders of at least 66 <sup>2</sup>/<sub>3</sub>% of our voting stock.

## **Director independence**

Under the rules of the Nasdaq Global Select Market, independent directors must comprise a majority of a listed company's board of directors within a specified period of the completion of an initial public offering. In addition, the rules of the Nasdaq Global Select Market require that, subject to specified exceptions, each member of a listed company's audit, compensation and nominating and corporate governance committees be independent. Under the rules of the Nasdaq Global Select Market, a director will only qualify as an "independent director" if, in the opinion of that company's board of directors, that person does not have a relationship that would interfere with the exercise of independent judgment in carrying out the responsibilities of a director. Compensation committee members must not have a relationship with us that is material to the director's ability to be independent from management in connection with the duties of a compensation committee member. Additionally, audit committee members must also satisfy the independence criteria set forth in Rule 10A-3 under the Exchange Act.

In order to be considered independent for purposes of Rule 10A-3, a member of an audit committee of a listed company may not, other than in his or her capacity as a member of the audit committee, the board of directors or any other board committee accept, directly or indirectly, any consulting, advisory or other compensatory fee from the listed company or any of its subsidiaries or be an affiliated person of the listed company or any of its subsidiaries.

Our board of directors has undertaken a review of the independence of each director. Based on information provided by each director concerning his background, employment and affiliations, our board of directors determined that Messrs. Earhart, Hart and Kowal and Ms. Harris do not have a relationship that would interfere with the exercise of independent judgment in carrying out the responsibilities of a director and that each of these directors is "independent" as that term is defined under the applicable rules and regulations of the SEC and the listing requirements and rules of the Nasdaq Global Select Market. In making these determinations, our board of directors considered the current and prior relationships that each non-employee director has with our company and all other facts and circumstances our board of directors deemed relevant in determining their independence, including the beneficial ownership of our capital stock by each non-employee director, and the transactions involving them described in the section titled "Certain relationships and related party transactions."

## **Committees of the board of directors**

Upon completion of this offering our board of directors will have an audit committee, a compensation committee and a nominating and corporate governance committee, each of which will have the composition and responsibilities described below upon completion of this offering. Each committee operates under a written charter that satisfies the applicable rules of the SEC and the listing standards of the Nasdaq Global Select Market. Members serve on these committees until their resignation or until otherwise determined by our board of directors.

### ***Audit committee***

Our audit committee is comprised of Messrs. Earhart, Kowal and Hart, each of whom is a non-employee member of our board of directors. Mr. Earhart is the chair of our audit committee. Our board of directors has determined that each of the members of our audit committee satisfies the requirements for independence and financial literacy under the rules and regulations of the Nasdaq Global Select Market and the SEC. Our board of directors has also determined that Mr. Earhart qualifies as an "audit committee financial expert" as defined in the SEC rules and satisfies the financial sophistication requirements of the Nasdaq Global Select Market. The audit committee is responsible for, among other things:

- selecting and hiring our independent registered public accounting firm;

## [Table of Contents](#)

- evaluating the performance and independence of our independent registered public accounting firm;
- approving the audit and pre-approving any non-audit services to be performed by our independent registered public accounting firm;
- reviewing our financial statements and related disclosures and reviewing our critical accounting policies and practices;
- reviewing the adequacy and effectiveness of our internal control policies and procedures and our disclosure controls and procedures;
- overseeing procedures for the treatment of complaints on accounting, internal accounting controls or audit matters;
- reviewing and discussing with management and the independent registered public accounting firm the results of our annual audit, our quarterly financial statements and our publicly filed reports;
- reviewing and approving in advance any proposed related-person transactions; and
- preparing the audit committee report that the SEC requires in our annual proxy statement.

### ***Compensation committee***

Our compensation committee is comprised of Ms. Harris and Messrs. Earhart and Kowal, each of whom is a non-employee member of our board of directors. Ms. Harris is the chair of our compensation committee. Our board of directors has determined that each member of our compensation committee meets the requirements for independence under the rules of the Nasdaq Global Select Market and the SEC, is a “non-employee director” within the meaning of Rule 16b-3 under the Exchange Act, and is an “outside director” within the meaning of Section 162(m) of the Code. The compensation committee is responsible for, among other things.

- reviewing and approving our president and chief executive officer’s and other executive officers’ annual base salaries, incentive compensation plans, including the specific goals and amounts, equity compensation, employment agreements, severance arrangements and change in control agreements and any other benefits, compensation or arrangements;
- administering our equity compensation plans;
- overseeing our overall compensation philosophy, compensation plans and benefits programs; and
- preparing the compensation committee report that the SEC will require in our annual proxy statement.

### ***Nominating and corporate governance committee***

Our nominating and corporate governance committee is comprised of Ms. Harris, Messrs Hart and Kowal each of whom is a non-employee member of our board of directors. Mr. Hart is the chair of our nominating and corporate governance committee. Our board of directors has determined that each member of our nominating and corporate governance committee meets the requirements for independence under the rules of the Nasdaq Global Select Market. The nominating and corporate governance committee will be responsible for, among other things:

- evaluating and making recommendations regarding the composition, organization and governance of our board of directors and its committees;

## [Table of Contents](#)

- evaluating and making recommendations regarding the creation of additional committees or the change in mandate or dissolution of committees;
- developing and monitoring a set of corporate governance guidelines and compliance with laws and regulations; and
- reviewing and approving conflicts of interest of our directors and officers, other than related-person transactions reviewed by the audit committee.

We intend to post the charters of our audit, compensation and nominating and corporate governance committees, and any amendments thereto that may be adopted from time to time, on our website. Information on or that can be accessed through our website is not part of this prospectus. Our board of directors may from time to time establish other committees.

### **Code of business conduct and ethics**

Prior to the completion of this offering, we will adopt a code of business conduct and ethics that is applicable to all of our employees, officers and directors. The full text of our code of business conduct and ethics will be available on our website at [www.altair.com](http://www.altair.com). We intend to post any amendment to our code of business conduct and ethics, and any waivers of such code for executive officers and directors, on our website. Information on or that can be accessed through our website is not part of this prospectus.

### **Compensation committee interlocks and insider participation**

No member of our compensation committee is or has been an officer or employee of our company. None of our executive officers currently serves, or during fiscal 2016 has served, as a member of the compensation committee or director (or other board committee performing equivalent functions or, in the absence of any such committee, the entire board of directors) of any entity that has one or more executive officers serving on our compensation committee or our board of directors.

Mr. Scapa, the chairman of our board of directors and our founder and chief executive officer owns more than 5% of our capital stock. Please see the section entitled "Certain relationships and related-party transactions."

## Director compensation

The table below shows the total compensation paid to or earned by each of our directors who are not executive officers during fiscal 2016 for service on our board of directors. Directors who are not executive officers receive a fee of \$20,000 for attending meetings of our board of directors and performing any related service as a director. No director has another arrangement with respect to cash fees. Directors are also eligible for awards under our 2012 Plan. Directors who are executive officers do not receive any additional compensation for their service on our board of directors. We reimburse our directors who are not executive officers for their reasonable out-of-pocket costs and travel expenses in connection with their attendance at board of directors and committee meetings.

Name	Fees earned or paid in cash (\$)	Option awards (\$) <sup>(1)(2)</sup>	All other compensation (\$)	Total (\$)
James E. Brancheau	20,000	—	23,025 <sup>(3)</sup>	43,025
Stephen Earhart	20,000	—	—	20,000
Trace Harris <sup>(4)</sup>	10,000	33,050	—	43,050
Jan Kowal	20,000	—	—	20,000
Richard Hart <sup>(5)</sup>	—	—	—	—
Marc. F. McMorris <sup>(6)</sup>	20,000	—	—	20,000
Oren Michels <sup>(7)</sup>	10,000	33,050	—	43,050

(1) The amounts in this column represent the aggregate grant date fair value of option awards granted to the directors in 2016, computed in accordance with FASB ASC Topic 718. For a discussion of the assumptions made in determining the grant date fair value of our equity awards, see Note 11 to our audited financial statements included elsewhere in this prospectus.

(2) Giving effect to the Recapitalization and our four-for-one stock split when we became a Delaware corporation as if such events had occurred on December 31, 2016, as of that date Mr. Brancheau held unexercised options to purchase 3,168 shares of our Class A common stock, Ms. Harris held unexercised options to purchase 20,000 shares of our Class A common stock, Mr. Kowal held unexercised options to purchase 20,000 shares of our Class A common stock, Mr. McMorris held unexercised options to purchase 20,000 shares of our Class A common stock, and Mr. Michels held unexercised options to purchase 20,000 shares of our Class A common stock.

(3) Reflects consulting fees paid to Mr. Brancheau for engineering services provided to us. Mr. Brancheau provides these engineering consulting services at a rate of \$150 per hour.

(4) Ms. Harris joined our board of directors on August 16, 2016.

(5) Mr. Hart joined our board of directors on April 1, 2017.

(6) Mr. McMorris resigned from our board of directors on December 31, 2016.

(7) Mr. Michels resigned from our board of directors on January 5, 2017.

## Executive compensation

Our named executive officers, for the fiscal year ended December 31, 2016, who consisted of our chief executive officer and our two most highly compensated executive officers for such year other than our chief executive officer, were:

- James R. Scapa, our Chief Executive Officer and Chairman;
- Howard N. Morof, our Chief Financial Officer; and
- Massimo Fariello, our Chief Strategy Officer.

### 2016 Summary compensation table

The following table provides information regarding the total compensation for services rendered in all capacities earned by our named executive officers for the fiscal year ended December 31, 2016.

Name and principal position	Year	Salary (\$)	Option awards (\$) <sup>(1)</sup>	Bonus (\$)	Nonequity incentive plan compensation (\$)	All other compensation (\$)	Total (\$)
James R. Scapa, <i>Chief Executive Officer and Chairman</i>	2016	809,000	—	310,000	—	11,330 <sup>(2)(3)</sup>	1,130,330
Howard N. Morof, <i>Chief Financial Officer</i>	2016	335,000	5,489	—	125,901 <sup>(4)</sup>	9,200 <sup>(2)(5)</sup>	475,590
Massimo Fariello, <i>Chief Strategy Officer</i> <sup>(6)</sup>	2016	—	5,392	—	—	459,694 <sup>(7)</sup>	465,086

- (1) The amounts in this column represent the aggregate grant date fair value of option awards granted to the named executive officer computed in accordance with FASB ASC Topic 718. For a discussion of the assumptions made in determining the grant date fair value of our equity awards, see Note 11 to our audited financial statements included elsewhere in this prospectus.
- (2) Includes a 401(k) matching contribution made by us under a matching program available to all participating employees.
- (3) Includes an annual automobile allowance of \$9,330.
- (4) Amounts for Mr. Morof were paid pursuant to our Executive Bonus Pool, described under the heading "Executive compensation—Employee benefit and equity compensation plans—Executive bonus pool." Payments under our Executive Bonus Pool are based on achievement of company financial targets and individual performance targets. Fifty percent (50%) of Mr. Morof's target bonus was paid in equal monthly installments during the year, and the remainder was paid after final bonus amounts were determined in March 2017.
- (5) Includes an automobile allowance of \$600 per month.
- (6) Mr. Fariello provides consulting services to us through Advanced Studies Holding Future, Srl, an Italian entity controlled by Mr. Fariello which we refer to as ASHF. Fiscal year 2016 compensation was payable pursuant to an unwritten arrangement, which was subsequently memorialized by a written agreement effective as of January 1, 2017, as subsequently amended effective as of January 1, 2017, described below under the heading "Executive compensation—Executive employment and service agreements and change in control arrangements—ASHF, Srl consulting agreement." His compensation is payable to ASHF in euros.
- (7) Compensation includes (i) base consulting fees, (ii) participation in our Executive Bonus Pool, described under the heading "Executive compensation—Employee benefit and equity compensation plans—Executive bonus pool," and (iii) special payments equal to fifty percent (50%) of the sum of each base consulting fee and each bonus payment. For 2016, compensation included (i) base consulting fees of \$221,380, (ii) target bonus payments of \$85,083, and (iii) special payments of \$153,231. Sixty percent (60%) of the bonus payments were paid in monthly installments during the year, and the remainder was paid after final bonus amounts were determined in March 2017. Special payments are made at the time of payment of the base consulting and bonus payments. The average exchange rate we used for fiscal year 2016 was €1.00 to \$1.1069 based on a publicly published exchange rate by an independent third party.



## Executive employment and service agreements and change in control arrangements

### James Scapa

Mr. Scapa is not party to an employment agreement or offer letter with the Company. Mr. Scapa's employment with the Company is at-will. His current base salary is \$830,000, and he is eligible for a target bonus of \$350,000 for fiscal 2017 in the discretion of our compensation committee. In addition, he receives an annual automobile allowance in the amount of \$9,330. He is also eligible to earn a matching contribution to our 401(k) Plan as determined annually by us.

### Howard N. Morof employment letter

We entered into an employment letter with Howard N. Morof, our chief financial officer, on January 10, 2013, which was subsequently amended and restated on July 19, 2017, to among other things, reflect his current compensation and to add language to address provisions of Section 409A of the Code. The employment letter has an indefinite term, and Mr. Morof's employment is at-will. Mr. Morof's current annual base salary is \$340,000. In addition, he is entitled to an automobile allowance of \$600 per month, and he is currently eligible to earn annual incentive compensation with a target bonus equal to \$135,000, payable from our Executive Bonus Pool applicable to other members of our senior executive team. He is also eligible to earn a matching contribution to our 401(k) Plan as determined annually by us.

If Mr. Morof resigns from employment for good reason, or is terminated without cause, he is entitled to 12 months of base salary plus any accrued annual bonus and a prorated annual bonus for the year of termination. He is also entitled to continued participation in our employee benefit programs, as if still employed as chief financial officer, during that 12 month period.

Pursuant to Mr. Morof's employment letter, if Mr. Morof is involuntarily terminated for any reason other than cause or voluntarily terminates his employment for good reason within the one month prior to, or twelve months following, a change in control (as defined in our 2012 Plan) Mr. Morof will also be entitled to a one-time special bonus equal to \$500,000, payable in full within three business days following such termination.

For purposes of Mr. Morof's employment letter, "cause" means the occurrence of any of the following:

- a felony conviction or admission of guilt (other than as relates to a misdemeanor motor vehicle accident);
- any material (i) willful, intentional, or deliberate neglect of Mr. Morof's proper responsibilities, or (ii) non-compliance by Mr. Morof with the lawful and reasonable orders or directions of our chief executive officer and/or our board of directors;
- participation in a fraud or act of dishonesty against us; or
- other material non-compliance with our policies or guidelines generally applicable to our C-level executives that results in substantial injury to us.

For purposes of Mr. Morof's employment letter, "good reason" means the occurrence of any of the following:

- a material diminution in Mr. Morof's duties or responsibilities or the assignment to Mr. Morof of duties that are materially inconsistent with his duties as our chief financial officer;

## [Table of Contents](#)

- any material reduction in Mr. Morof's compensation and benefit opportunities, unless applied in a substantially equal or pro rata fashion across our C-level executives; or
- the requirement to relocate Mr. Morof's principal place of employment more than 30 miles from our Troy, Michigan offices.

Mr. Morof is required to provide written notice of any such good reason condition and we shall have 30 days from receipt of such written notice to remedy such condition.

### **AShF, Srl consulting agreement**

We entered into a consulting agreement with AShF, a Società a Responsabilità Limitata incorporated under the laws of Italy, which is effective as of January 1, 2017 and was subsequently amended effective as of January 1, 2017. AShF is wholly-owned by our chief strategy officer, Massimo Fariello, and Mr. Fariello serves as chief executive officer of AShF.

Under the consulting agreement, AShF agreed to make available Mr. Fariello to provide services to us, and Mr. Fariello would be located in Torino, Italy. The consulting agreement will continue for a one year initial term that is projected to end December 31, 2017, and is renewed automatically for additional successive terms of one year each, except that either we or AShF may terminate the agreement at any time upon sixty days prior written notice to the other party.

AShF's compensation includes (i) base consulting fees, which are currently €205,000 per year, (ii) participation in our Executive Bonus Pool, the terms of which are described below under the heading "Executive compensation—Employee benefit and equity compensation plans—Executive bonus pool" with an annual target bonus equal to €85,000 and (iii) a special payment equal to fifty percent (50%) of each base consulting fee payment and each target bonus payment. In addition, we reimburse AShF for actual out-of-pocket expenses incurred in furtherance of AShF's performance of services, plus travel expenses, other than vehicle expenses for travel by car within Italy.

### **Benefits upon termination or change in control**

Each of Messrs. Morof and Fariello are party to certain stock option agreements with us which provide that if such individual's employment is terminated by us for any reason other than cause or by the named executive officer voluntarily for good reason (each as defined in our 2012 Plan) within one month prior to or within 12 months following a change in control (as defined in our 2012 Plan), all unvested options shall vest in full.

Mr. Morof's employment letter also provides for certain severance benefits, the terms of which are described above under the heading "Executive compensation—Executive employment and service agreements and change in control arrangements—Howard N. Morof employment letter."

## Outstanding equity awards at fiscal year end 2016

The following table sets forth information regarding outstanding equity awards held by our named executive officers as of December 31, 2016. All references to our Class A shares herein refer to our currently existing Class A shares following the Recapitalization.

Name	Grant date	Number of securities underlying unexercised options (#) exercisable	Option awards		Option exercise price (\$)	Option expiration date
			Number of securities underlying unexercised options (#) unexercisable	Number of securities underlying unexercised options (#)		
James R. Scapa	7/1/2010 <sup>(1)</sup>	1,734,996	—	—	0.64	6/30/2020
Howard N. Morof	8/6/2013 <sup>(2)</sup>	388,920	170,000	—	2.48	8/5/2023
	12/15/2014 <sup>(3)</sup>	1,732	1,728	—	3.79	12/14/2024
	12/17/2015 <sup>(4)</sup>	756	2,268	—	3.84	12/16/2025
	5/17/2016 <sup>(5)</sup>	—	3,872	—	3.64	5/16/2026
Massimo Fariello	7/1/2010 <sup>(1)</sup>	60,000	—	—	0.64	6/30/2020
	12/21/2012 <sup>(6)</sup>	800	—	—	2.48	11/20/2022
	12/15/2014 <sup>(7)</sup>	1,584	1,584	—	3.79	12/14/2024
	12/17/2015 <sup>(8)</sup>	816	2,436	—	3.84	12/16/2025
	5/17/2016 <sup>(9)</sup>	—	3,804	—	3.64	5/16/2026

(1) All of the Class A shares subject to the option were fully vested as of July 1, 2010.

(2) All of the Class A shares subject to the option were fully vested as of August 6, 2017.

(3) One-fourth of the Class A shares subject to the option vested on each of December 15, 2015, and December 15, 2016, and one-fourth of the Class A shares subject to the option are scheduled to vest on each of the next two anniversaries of December 15<sup>th</sup> thereafter, in each case, subject to continued employment with us.

(4) One-fourth of the Class A shares subject to the option vested on December 17, 2016, and one-fourth of the Class A shares subject to the option are scheduled to vest on each of the next three anniversaries of December 17<sup>th</sup> thereafter, in each case, subject to continued employment with us.

(5) One-fourth of the Class A shares subject to the option vested on May 17, 2017, and one-fourth of the Class A shares subject to the option are scheduled to vest on each of the next three anniversaries of May 17<sup>th</sup> thereafter, in each case, subject to continued employment with us.

(6) All of the Class A shares subject to the option were fully vested as of December 21, 2016.

(7) One-fourth of the Class A shares subject to the option vested on each of December 15, 2015, and December 15, 2016, and one-fourth of the Class A shares subject to the option are scheduled to vest on each of the next two anniversaries of December 15<sup>th</sup> thereafter, in each case, subject to continued service with us.

(8) One-fourth of the Class A shares subject to the option vested on December 17, 2016, and one-fourth of the Class A shares subject to the option are scheduled to vest on each of the next three anniversaries of December 17<sup>th</sup> thereafter, in each case, subject to continued service with us.

(9) One-fourth of the Class A shares subject to the option vested on May 17, 2017, and one-fourth of the Class A shares subject to the option are scheduled to vest on each of the next three anniversaries of May 17<sup>th</sup> thereafter, in each case, subject to continued service with us.

See the section entitled “Executive compensation—Benefits upon termination or change in control” for a description of vesting acceleration applicable to stock options held by our named executive officers.

## Employee benefit and equity compensation plans

The equity incentive plans described in this section are our 2017 Equity Incentive Plan, or our 2017 Plan, which we intend to adopt prior to the completion of this offering, our 2012 Plan, our 2001 NQSO Plan, and our 2001 ISO and NQSO Plan. Prior to the Recapitalization, each of our 2012 Plan, 2001 NQSO Plan, and 2001 ISO and NQSO Plan provided for the grant of shares of our Class B nonvoting common stock. As a result of the Recapitalization, in order to prevent the enlargement of participants’ rights, each of the 2012 Plan, 2001 NQSO

Plan, and 2001 ISO and NQSO Plan was amended on April 3, 2017 to provide that the definition of common stock in each such plan, and the shares issuable pursuant to each option agreement entered into thereunder, would mean Class A voting common stock. The following description of each of our equity incentive plans gives effect to the amendment to each plan and each option agreement entered into thereunder to provide for the issuance of Class A voting common stock as if it had occurred on December 31, 2016.

### **Altair Engineering Inc. 2017 equity incentive plan**

On September 27, 2017, our board of directors adopted our 2017 Plan, and we expect our 2017 Plan to be approved by our stockholders. Subject to stockholder approval, our 2017 Plan will be effective one business day prior to the effective date of the registration statement of which this prospectus forms a part. Our 2017 Plan will provide for the grant of incentive stock options, within the meaning of Section 422 of the Code, to our employees and any parent and subsidiary corporations' employees, and for the grant of nonstatutory stock options, stock appreciation rights, restricted stock, restricted stock units, performance units, performance shares, other cash-based awards and other stock-based awards to our employees, directors and consultants and our parent, subsidiary, and affiliate corporations' employees and consultants.

*Authorized shares.* 6,207,976 shares of our Class A common stock are reserved for issuance under our 2017 Plan. The number of shares available for issuance under our 2017 Plan will also include an annual increase on the first day of each fiscal year beginning in fiscal 2018, equal to the lesser of:

- three percent (3%) of the outstanding shares of all classes of common stock as of the last day of our immediately preceding fiscal year; or
- such other amount as our administrator may determine.

*Plan administration.* Our compensation committee will administer our 2017 Plan. In the case of awards intended to qualify as "performance-based compensation" within the meaning of Section 162(m) of the Code, our committee will consist of two or more "outside directors" within the meaning of Section 162(m) of the Code. In addition, if we determine it is desirable to qualify transactions under our 2017 Plan as exempt under Rule 16b-3 of the Exchange Act, or Rule 16b-3, such transactions will be structured to satisfy the requirements for exemption under Rule 16b-3. Subject to the provisions of our 2017 Plan, the administrator will have the power to administer our 2017 plan, including but not limited to, the power to: (i) determine fair market value; (ii) select service providers to whom awards may be granted under our 2017 Plan; (iii) to determine the number of shares covered by each award granted under our 2017 Plan; (iv) to approve the forms of award agreement for use under our 2017 Plan; (v) to determine the terms and conditions, not inconsistent with the terms of our 2017 Plan, of any award granted thereunder; (vi) to institute and determine the terms and conditions of an exchange program; (vii) to construe and interpret the terms of our 2017 Plan and awards granted thereunder; (viii) to prescribe, amend and rescind rules and regulations relating to our 2017 Plan; (ix) to modify or amend each award; (x) to allow participants to satisfy tax withholding obligation as provided under our 2017 Plan; (xi) to authorize any person to execute on behalf of the Company any instrument required to effect the grant of an award previously granted by the administrator; (xii) to allow a participant to defer the receipt of the payment of cash or the delivery of shares that would otherwise be due to such participant under an award; and (xiii) to make all other determinations deemed necessary or advisable for administering our 2017 Plan.

*Stock options.* The exercise price of all options granted under our 2017 Plan must at least be equal to the fair market value of our Class A common stock on the date of grant (110% for incentive stock options granted to 10% stockholders). The term of an incentive stock option may not exceed 10 years (five years for incentive stock options granted to 10% stockholders). After a termination of service, a participant may generally exercise his or her option, to the extent vested for 90 days following a termination (or such other time period as set

## [Table of Contents](#)

forth in the option agreement) or twelve months if termination is on account of death or disability. However, in no event may an option be exercised after the expiration of its term.

**Restricted stock.** Restricted stock awards are grants of shares of our Class A common stock that vest in accordance with terms and conditions established by the administrator. The administrator will determine the number of shares of restricted stock granted to any participant and, subject to the provisions of our 2017 Plan, will determine the terms and conditions of such awards. Recipients of restricted stock awards may have voting and dividend rights with respect to such shares upon grant without regard to vesting. Shares of restricted stock that do not vest are returned to us and again will become available for grant under our 2017 Plan.

**Restricted stock units.** Subject to the provisions of our 2017 Plan, the administrator will determine the terms and conditions of restricted stock units, including the vesting criteria, which may include accomplishing specified performance criteria or continued service to us, and the form and timing of payment. Notwithstanding the foregoing, the administrator, in its sole discretion, may accelerate the time at which any restrictions will lapse or be removed.

**Stock appreciation rights.** Stock appreciation rights allow the recipient to receive the appreciation in the fair market value of our Class A common stock between the exercise date and the date of grant. Stock appreciation rights may not have a term exceeding 10 years. After the termination of service of a participant, he or she may exercise his or her stock appreciation right for the period of time stated in his or her stock appreciation right agreement. However, in no event may a stock appreciation right be exercised after the expiration of its term. Subject to the provisions of our 2017 Plan, the administrator determines the other terms of stock appreciation rights, including when such rights become exercisable and whether to pay any increased appreciation in cash or with shares of our Class A common stock, or a combination thereof, except that the per share exercise price for the shares to be issued pursuant to the exercise of a stock appreciation right will be no less than 100% of the fair market value per share on the date of grant.

**Performance units and performance shares.** Performance units and performance shares are awards that will result in a payment to a participant only if performance goals established by the administrator are achieved or the awards otherwise vest. The administrator will establish organizational or individual performance goals or other vesting criteria in its discretion, which, depending on the extent to which they are met, will determine the number and the value of performance units and performance shares to be paid out to participants. After the grant of a performance unit or performance share, the administrator, in its sole discretion, may reduce or waive any performance criteria or other vesting provisions for such performance unit or performance share. Performance units shall have an initial dollar value established by the administrator prior to the grant date. Performance shares shall have an initial value equal to the fair market value of our Class A common stock on the grant date. The administrator, in its sole discretion, may pay earned performance units or performance shares in the form of cash, in shares or in some combination thereof.

**Other cash-based awards and other stock-based awards.** Our 2017 Plan provides for the grant of other types of equity-based or equity-related awards. Other cash-based awards and other stock-based awards will be granted in such amounts and subject to such terms and conditions as determined by the administrator, in its sole discretion. These awards may involve the actual transfer of shares of our Class A common stock, or payment in cash or otherwise of amounts based upon the value of shares of our Class A common stock.

**Outside directors.** Our 2017 Plan provides that all non-employee directors will be eligible to receive all types of awards, except for incentive stock options, under our 2017 Plan. During any fiscal year, a non-employee director may not be granted (i) cash-settled awards with a grant date fair value (determined in accordance with GAAP) of more than \$500,000, or (ii) stock-settled awards with a grant date fair value (determined in accordance with GAAP) of more than \$500,000.

## [Table of Contents](#)

*Non-transferability.* Unless the administrator provides otherwise, our 2017 Plan generally will not allow for the transfer of awards and only the recipient of an award may exercise an award during his or her lifetime.

*Section 162(m).* For awards that are intended to be exempt from the deductibility limit of Section 162(m) of the Code, no participant may receive in any one calendar year options or stock appreciation rights with respect to more than 620,800 shares of our Class A common stock, or awards that are denominated in shares of our Class A common stock (other than options and stock appreciation rights) relating to more than 620,800 shares in the aggregate. In addition, the maximum cash amount payable to any participant in any one calendar year of the Company with respect to awards (other than options and stock appreciation rights) that are intended to be exempt from the deductibility limit of Section 162(m) of the Code is \$3,000,000.

*Certain adjustments.* In the event of certain changes in our capitalization, to prevent diminution or enlargement of the benefits or potential benefits available under our 2017 Plan, the administrator will adjust the number and class of shares that may be delivered under our 2017 Plan and the number, class, and price of shares covered by each outstanding award, and the numerical share limits set forth in our 2017 Plan. In the event of our proposed liquidation or dissolution, the administrator will notify participants as soon as practicable, and all awards will terminate immediately prior to the consummation of such proposed transaction.

*Change in control.* Our 2017 Plan will provide that in the event of a “merger” or “change in control,” as defined under our 2017 Plan, each outstanding award will be treated as the administrator determines, except that if a successor corporation or its parent or subsidiary does not assume or substitute an equivalent award for any outstanding award, then such award will fully vest, all restrictions on such award will lapse, all performance goals or other vesting criteria applicable to such award will be deemed achieved at 100% of target levels, and such award will become fully exercisable, if applicable, for a specified period prior to the transaction. The award will then terminate upon the expiration of the specified period of time.

*Amendment; termination.* The administrator will have the authority to amend, suspend or terminate our 2017 Plan, provided such action does not impair the existing rights of any participant without his or her consent. Our 2017 Plan will automatically terminate on the tenth anniversary of the date it was adopted by our board of directors, unless terminated earlier pursuant to the terms of our 2017 Plan.

### **Altair Engineering Inc. 2012 incentive and non-qualified stock option plan**

On December 20, 2012, our board of directors adopted, and our stockholders approved, our 2012 Plan, effective as of December 20, 2012.

*Authorized shares.* 5,200,000 shares of our Class A common stock were reserved for issuance under our 2012 Plan. No options or shares will be available for issuance under our 2012 Plan after this offering. As of December 31, 2016, options to purchase 1,799,652 shares of our Class A common stock remained outstanding under our 2012 Plan. Our 2012 Plan provides for the grant of incentive stock options and non-qualified stock options to our service providers. Following this offering, our 2012 Plan will continue to govern outstanding awards granted thereunder.

*Plan administration.* Our board of directors administers our 2012 Plan. Subject to the provisions of our 2012 Plan, the administrator has the power to administer the plan, including but not limited to, the power to: (i) prescribe, amend and rescind rules and regulations relating to our 2012 Plan; (ii) select recipients to receive options; (iii) determine the number of shares subject to options; (iv) determine the terms and form of options; (v) determine whether options will be granted singly, in combination or in tandem with, in replacement of, or as alternatives to other options under our 2012 Plan or any other incentive or compensation plan offered by us; (vi) construe and interpret our 2012 Plan, any option agreement and any other document executed pursuant

## [Table of Contents](#)

thereto; (vii) correct any defect or omission, or reconcile any inconsistency in our 2012 Plan, any option or any option agreement; (viii) determine when an option has been earned and/or vested; (ix) accelerate or defer, with the consent of the participant, the vesting of any option; (x) authorize any person on our behalf to execute documents to effectuate the grant of an option as made by our board of directors under our 2012 Plan; (xi) with the consent of any adversely affected participant, effect (A) the reduction of the exercise price of any outstanding option under our 2012 Plan; (B) the cancellation of any outstanding option under our 2012 Plan and the grant in substitution therefor of (1) a new option under our 2012 Plan or another equity plan offered by us covering the same or a different number of shares of our Class A common stock, (2) cash, and/or (3) other valuable consideration as determined by our board of directors in its sole discretion; or (C) any other action that is treated as a repricing under generally accepted accounting principles; (xii) with the consent of any adversely affected participant, otherwise adjust the terms of an option previously issued to such participant; (xiii) determine whether a transaction or event should be treated as a change in control, and if our board of directors determines that a transaction or event shall be a change in control, the effect of that change in control; and (xiv) make all other determinations deemed necessary or advisable for administration of our 2012 Plan. Our board of directors shall have the sole authority to determine the fair market value of our Class A common stock. Our board of directors shall have the authority to grant options to eligible participants who are foreign nationals, without amending our 2012 Plan, provided such grants are not inconsistent with the terms of our 2012 Plan. Our board of directors may make such modifications to the 2012 Plan as are necessary or advisable to comply with the laws of other countries in which we operate or have eligible participants.

*Stock options.* The exercise price per share of all incentive stock options and non-qualified stock options must be at least 100% of the fair market value per share of our Class A common stock on the date of grant (110% for incentive stock options for 10% stockholders). The term of an option cannot exceed ten years (five years for 10% stockholders). After a termination of service, the participant may generally exercise his or her option, to the extent vested, for 90 days following a termination (or such other time period as set forth in the option agreement) or twelve months if termination is on account of death or disability. However, in no event may an option be exercised later than the expiration of its term.

*Non-transferability.* Our 2012 Plan generally does not allow for the transfer of options except by the laws of descent and distribution and only the recipient of an option may exercise such an award during his or her lifetime.

*Certain adjustments.* In the event of certain changes in our capitalization without our receipt of consideration, such as a reorganization, takeover or liquidation, then the number of shares reserved for issuance under our 2012 Plan, the exercise price of and number of shares subject to outstanding options as well as any other factor pertaining to outstanding options shall be proportionally adjusted, subject to action by our board of directors or stockholders and compliance with securities laws.

*Reorganization.* Notwithstanding any other provision of our 2012 Plan to the contrary, our 2012 Plan provides that in the event of a reorganization, subject to any required action by our stockholders, our board of directors may make any adjustments to (i) the class and/or number of shares covered under our 2012 Plan; (ii) the number of shares for which each outstanding option pertains; (iii) the exercise price of an option; and/or (iv) any other aspect of our 2012 Plan to prevent the dilution or enlargement of the rights of participants under our 2012 Plan in connection with any increase or decrease in the number of issued and outstanding shares of our Class A common stock resulting from the payment of a stock dividend, stock split, reverse stock split, or any other event which results in an increase or decrease in the number of issued and outstanding shares of our Class A common capital stock without receipt of adequate consideration.

*Change in control.* Unless otherwise set forth in an option agreement, if (i) a change in control occurs (as defined in our 2012 Plan) and (ii) within the one month prior to, or the twelve months following the date of the

change in control, a participant's employment is involuntarily terminated without cause or the participant voluntarily terminates for good reason (as such term is defined in our 2012 Plan), then all outstanding options held by such participant shall be fully vested. In addition, our board of directors has discretion to take action with respect to outstanding options in the event of a change in control, including substitution for an equivalent option, assumption or cancellation in exchange for a payment of cash or stock or any combination of cash and stock-based on the price per share received or to be received by our other stockholders in such instance.

*Modification, extension and renewal of options.* Our board of directors may modify, extend or renew any outstanding options or accept cancellation of an outstanding option in substitution for a new option; however, our board of directors cannot adversely impact any rights or obligations under any previously granted option without the participant's consent.

*Amendment; termination.* Our board of directors may amend, terminate, suspend, or discontinue our 2012 Plan at any time, provided that no amendment, termination or modification of our 2012 Plan may affect any option previously granted without the participant's consent. Approval by our stockholders is required to (i) increase the number of shares subject to our 2012 Plan; (ii) change the designation of the class of persons eligible to receive options; (iii) increase the maximum duration of an option; (iv) change the manner of determining the exercise price of an option; (v) extend the term of our 2012 Plan; and (vi) amend the amendment and termination provision of our 2012 Plan in a way that defeats its purpose.

### **Altair Engineering Inc. 2001 non-qualified stock option plan**

On October 31, 2001, our board of directors adopted, and our stockholders approved, our 2001 NQSO Plan, effective as of December 1, 2001.

*Authorized shares.* 14,000,000 shares of our Class A common stock were reserved for issuance under our 2001 NQSO Plan. Under the terms of our 2001 NQSO Plan, no options may be issued after December 31, 2003, and, accordingly, no shares will be available for issuance under our 2001 NQSO Plan after this offering. As of December 31, 2016, options to purchase 6,347,840 shares of our Class A common stock remained outstanding under our 2001 NQSO Plan. Following this offering, our 2001 NQSO Plan will continue to govern outstanding awards granted thereunder.

*Plan administration.* Our board of directors administers our 2001 NQSO Plan. Subject to the provisions of our 2001 NQSO Plan, the administrator has the power to administer the plan, including but not limited to, the power to: (i) prescribe, amend and rescind rules and regulations relating to our 2001 NQSO Plan; (ii) select recipients to receive options; (iii) determine the number of shares subject to options; (iv) determine the terms and form of options; (v) determine whether options will be granted singly, in combination or in tandem with, in replacement of, or as alternatives to other options under our 2001 NQSO Plan or any other incentive or compensation plan offered by us; (vi) construe and interpret our 2001 NQSO Plan, any option agreement and any other document executed pursuant thereto; (vii) correct any defect or omission, or reconcile any inconsistency in our 2001 NQSO Plan, any option or any option agreement; (viii) determine when an option has been earned; (ix) authorize any person on our behalf to execute documents to effectuate the grant of an option as made by our board of directors under our 2001 NQSO Plan; (x) with the consent of the participant, reprice, cancel and reissue, or otherwise adjust the terms of a previously granted option; and (xi) make all other determinations deemed necessary or advisable for administration of our 2001 NQSO Plan. Our board of directors shall have the sole authority to determine the fair market value of our Class A common stock.

*Stock options.* Eligibility to receive options under our 2001 NQSO Plan was limited to employees that were then participants in our phantom stock plan. After a termination of service for cause or a voluntary termination, the participant may generally exercise his or her option for three months following such termination (or such



## [Table of Contents](#)

other time periods set forth in the option agreement). Absent a termination for cause or a voluntary termination, each option will remain outstanding until the expiration of its term. In no event may an option be exercised later than the expiration of its term.

*Non-transferability.* Our 2001 NQSO Plan generally does not allow for the transfer of options except by the laws of descent and distribution and only the recipient of an option may exercise such option during his or her lifetime.

*Certain adjustments.* In the event of certain changes in our capitalization without our receipt of consideration, such as a reorganization, takeover or liquidation, then the number of shares reserved for issuance under our 2001 NQSO Plan, the exercise price of and number of shares subject to outstanding options as well as any other factor pertaining to outstanding options shall be proportionally adjusted, subject to action by our board of directors or stockholders and compliance with securities laws.

*Reorganization.* Notwithstanding any other provision of our 2001 NQSO Plan to the contrary, our 2001 NQSO Plan provides that in the event of a reorganization, subject to any required action by our stockholders, our board of directors may make any adjustments to: (i) the class and/or number of shares covered under our 2001 NQSO Plan; (ii) the number of shares for which each outstanding option pertains; (iii) the exercise price of an option; and/or (iv) any other aspect of our 2001 NQSO Plan to prevent the dilution or enlargement of the rights of participants under our 2001 NQSO Plan in connection with any increase or decrease in the number of issued and outstanding shares of our Class A common stock resulting from the payment of a stock dividend, stock split, reverse stock split, or any other event which results in an increase or decrease in the number of issued and outstanding shares of our Class A common capital stock without receipt of adequate consideration.

*Merger and consolidation.* If we are a party to a merger or consolidation as the surviving corporation, each outstanding option shall pertain to the securities of our company to which a holder of the number of shares issued would be entitled, subject to any required action by our stockholders. If we are a party to a merger or consolidation and we are not the surviving corporation, unless the surviving corporation expressly assumes the outstanding options, our board of directors shall exercise reasonable efforts to provide participants advanced notice before the effective date of the transaction to exercise options, subject to any required action by our stockholders.

*Modification, extension and renewal of options.* Our board of directors may modify, extend or renew any outstanding options or accept cancellation of an outstanding option in substitution for a new option; however, our board of directors cannot adversely impact any rights or obligations under any previously granted option without the participant's consent.

*Amendment; termination.* Our board of directors may amend, terminate, suspend, or discontinue our 2001 NQSO Plan at any time, provided that no amendment, termination or modification of our 2001 NQSO Plan may affect any option previously granted without the participant's consent. Approval by our stockholders is required to (i) increase the number of shares subject to our 2001 NQSO Plan; (ii) change the designation of the class of persons eligible to receive options; (iii) increase the maximum duration of an option; (iv) change the manner of determining the exercise price of an option; (v) extend the term of our 2001 NQSO Plan; and (vi) amend the amendment and termination provision of our 2001 NQSO Plan in a way that defeats its purpose.

### **Altair Engineering Inc. 2001 incentive and non-qualified stock option plan**

On March 31, 2001, our board of directors adopted, and our stockholders approved, our 2001 ISO and NQSO Plan, effective as of January 31, 2001.

*Authorized shares.* 4,624,448 shares of our Class A common stock were reserved for issuance under our 2001 ISO and NQSO Plan. No options or shares will be available for issuance under our 2001 ISO and NQSO Plan after

## [Table of Contents](#)

this offering. As of December 31, 2016, options to purchase 2,972,744 shares of our Class A common stock remained outstanding under our 2001 ISO and NQSO Plan. Our 2001 ISO and NQSO Plan provides for the grant of incentive stock options and non-qualified stock options to our service providers. Following this offering, our 2001 ISO and NQSO Plan will continue to govern outstanding awards granted thereunder.

*Plan administration.* Our board of directors administers our 2001 ISO and NQSO Plan. Subject to the provisions of our 2001 ISO and NQSO Plan, the administrator has the power to administer the plan, including but not limited to, the power to: (i) prescribe, amend and rescind rules and regulations relating to our 2001 ISO and NQSO Plan; (ii) select recipients to receive options; (iii) determine the number of shares subject to options; (iv) determine the terms and form of options; (v) determine whether options will be granted singly, in combination or in tandem with, in replacement of, or as alternatives to other options under our 2001 ISO and NQSO Plan or any other incentive or compensation plan offered by us; (vi) construe and interpret our 2001 ISO and NQSO Plan, any option agreement and any other document executed pursuant thereto; (vii) correct any defect or omission, or reconcile any inconsistency in our 2001 ISO and NQSO Plan, any option or any option agreement; (viii) determine when an option has been earned and/or vested; (ix) accelerate or defer, with the consent of a participant, the vesting of any option; (x) authorize any person on our behalf to execute documents to effectuate the grant of an option as made by our board of directors under our 2001 ISO and NQSO Plan; (xi) with the consent of the participant, reprice, cancel and reissue, or otherwise adjust the terms of a previously granted option; and (xii) make all other determinations deemed necessary or advisable for administration of our 2001 ISO and NQSO Plan. Our board of directors shall have the sole authority to determine the fair market value of our Class A common stock.

*Stock options.* The exercise price per share of all incentive stock options must be at least 100% of the fair market value per share of our Class A common stock on the date of grant (110% for 10% stockholders) and the exercise price per share of all non-qualified stock options must be at least 100% of the net book value of our shares on the date of grant. The term of an option cannot exceed ten years (five years for 10% stockholders). After a termination of service, the participant may generally exercise his or her option, to the extent vested, for 90 days following a termination (or such other time period as set forth in the option agreement), or twelve months if termination is on account of death or disability. However, in no event may an option be exercised later than the expiration of its term.

*Non-transferability.* Our 2001 ISO and NQSO Plan generally does not allow for the transfer of options except by the laws of descent and distribution and only the recipient of an option may exercise his or her option during his or her lifetime.

*Certain adjustments.* In the event of certain changes in our capitalization without our receipt of consideration, such as a reorganization, takeover or liquidation, then the number of shares reserved for issuance under our 2001 ISO and NQSO Plan, the exercise price of and number of shares subject to outstanding options as well as any other factor pertaining to outstanding options shall be proportionally adjusted, subject to action by our board of directors or stockholders and compliance with securities laws.

*Reorganization.* Notwithstanding any other provision in our 2001 ISO and NQSO Plan to the contrary, our 2001 ISO and NQSO Plan provides that in the event of a reorganization, subject to any required action by our stockholders, our board of directors may make any adjustments to: (i) the class and/or number of shares covered under our 2001 ISO and NQSO Plan; (ii) the number of shares for which each outstanding option pertains; (iii) the exercise price of an option; and/or (iv) any other aspect of our 2001 ISO and NQSO Plan to prevent the dilution or enlargement of the rights of participants under our 2001 ISO and NQSO Plan in connection with any increase or decrease in the number of issued and outstanding shares of our Class A common stock resulting from the payment of a stock dividend, stock split, reverse stock split, or any other event which results in an increase or decrease in the number of issued and outstanding shares of our Class A common capital stock without receipt of adequate consideration.

## [Table of Contents](#)

*Change in control.* Unless otherwise set forth in an option agreement, if a change in control occurs (as defined in our 2001 ISO and NQSO Plan) our board of directors has discretion to (i) accelerate the vesting of any outstanding options, or (ii) upon at least ten days' notice to any affected participants, cancel any outstanding options and pay to such participants, in cash or stock, or any combination thereof, the value of such options based upon the price per share of our Class A common stock received or to be received by our other stockholders in the change in control.

*Modification, extension and renewal of options.* Our board of directors may modify, extend or renew any outstanding options or accept cancellation of outstanding options in substitution for new options; however, our board of directors cannot adversely impact any rights or obligations under any previously granted option without the participant's consent.

*Amendment; termination.* Our board of directors could amend, terminate, suspend, or discontinue our 2001 ISO and NQSO Plan at any time, provided that no amendment, termination or modification of our 2001 ISO and NQSO Plan could affect any option previously granted without the participant's consent. Approval by our stockholders was required to (i) increase the number of shares subject to our 2001 ISO and NQSO Plan; (ii) change the designation of the class of persons eligible to receive options; (iii) increase the maximum duration of an option; (iv) change the manner of determining the exercise price of an option; (v) extend the term of our 2001 ISO and NQSO Plan; and (vi) amend the amendment and termination provision of our 2001 ISO and NQSO Plan in a way that defeats its purpose. In accordance with the terms of our 2001 ISO and NQSO Plan, our 2001 ISO and NQSO Plan expired in January 2011.

### **401(k) plan**

We maintain a tax-qualified retirement plan, or our 401(k) Plan, that provides eligible employees in the United States with an opportunity to save for retirement on a tax-advantaged basis. Under the terms of our 401(k) Plan, participants are able to defer up to 80% of their eligible compensation subject to applicable annual Internal Revenue Service limits. Participants are immediately and fully vested in their own contributions. Our 401(k) Plan permits us to make discretionary matching contributions and discretionary contributions to eligible participants, subject to five year graded vesting: twenty percent (20%) vests after one year, forty percent (40%) after two years, sixty percent (60%) after three years, eighty percent (80%) after four years and 100% after five years. Our 401(k) Plan has an automatic enrollment feature for all employees hired on or after April 1, 2014, automatically withholding elective deferrals equal to 3% of eligible compensation, unless the participant affirmatively changes the deferral amount.

### **Executive bonus pool**

Each year we establish an annual executive bonus pool, or our Executive Bonus Pool, for (i) our C-level executive officers, excluding our chief executive officer, (ii) employees who report directly to our chief executive officer and (iii) vice presidents in key positions as selected by us. Incentives under our Executive Bonus Pool are based upon each individual's target amount as set and approved by our chief executive officer, multiplied by the achievement of (i) certain company financial targets and (ii) certain individual performance targets. Individuals are paid fifty percent (50%) of their potential bonus under our Executive Bonus Pool in equal monthly installments each year, and any additional earned bonus is paid after final bonus amounts are determined. We retain the right to change or suspend payment of potential bonuses at any time.

### **Limitation on liability and indemnification matters**

Our Delaware certificate of incorporation and bylaws contain provisions that limit the personal liability of our directors for monetary damages to the fullest extent permitted by Delaware law. Consequently, our directors

## [Table of Contents](#)

will not be personally liable to us or our stockholders for monetary damages for any breach of fiduciary duties as directors, except liability for:

- any breach of the director's duty of loyalty to us or our stockholders;
- any act or omission not in good faith or that involves intentional misconduct or a knowing violation of law;
- unlawful payments of dividends or unlawful stock repurchases or redemptions as provided in Section 174 of the Delaware General Corporation Law; or
- any transaction from which the director derived an improper personal benefit.

Our Delaware certificate of incorporation provides that we must indemnify our directors to the fullest extent permitted by Delaware law. In addition, our Delaware bylaws provide that we must indemnify our directors and officers to the fullest extent permitted by Delaware law. Our Delaware bylaws also provide that we will advance expenses incurred by a director or officer in advance of the final disposition of any action or proceeding, and permit us to secure insurance on behalf of any officer, director, employee or other agent for any liability arising out of his or her actions in that capacity, regardless of whether we would otherwise be permitted to indemnify him or her under the provisions of Delaware law. We plan to enter into and expect to continue to enter into agreements to indemnify our directors, executive officers and other employees as determined by the board of directors. With certain exceptions, these agreements provide for indemnification for related expenses including, among others, attorneys' fees, judgments, fines and settlement amounts incurred by any of these individuals in any action or proceeding. We believe that these bylaw provisions and indemnification agreements are necessary to attract and retain qualified persons as directors and officers. We also maintain directors' and officers' liability insurance.

The limitation of liability and indemnification provisions in our Delaware certificate of incorporation and bylaws may discourage stockholders from bringing a lawsuit against our directors for breach of their fiduciary duty of care. They may also reduce the likelihood of derivative litigation against our directors and officers, even though an action, if successful, might benefit us and other stockholders. Further, a stockholder's investment may be adversely affected to the extent that we pay the costs of settlement and damage awards against directors and officers pursuant to these indemnification provisions. At present, there is no pending litigation or proceeding involving any of our directors, officers or employees for which indemnification is sought, and we are not aware of any threatened litigation that may result in claims for indemnification.

## Certain relationships and related party transactions

In addition to the executive officer and director compensation arrangements discussed above in the sections titled “Management” and “Executive Compensation,” the following is a description of each transaction since January 1, 2014 and each currently proposed transaction in which:

- we have been or are to be a participant;
- the amounts involved exceeded or will exceed \$120,000; and
- any of our directors, executive officers or beneficial holders of more than 5% of any class of our capital stock, or entities affiliated with them, or any immediate family members of or person sharing the household with any of these individuals, had or will have a direct or indirect material interest.

### Redemptions of our old Class B and old Class A common stock

On November 10, 2012, we redeemed 525,600 shares of our old Class A Common Stock held by George J. Christ, one of the holders of more than 5% of our outstanding capital stock, for an aggregate purchase price of \$1,971,000, payable in 36 monthly installments with an interest rate of 1% per year, commencing on December 10, 2012 and ending on November 10, 2015.

On December 10, 2012, we redeemed 525,600 shares of our old Class A Common Stock held by Mark Kistner, Trustee of the Mark Kistner Revocable Living Trust dated January 22, 1998, as amended, one of the holders of more than 5% of our outstanding capital stock, for an aggregate purchase price of \$1,971,000, payable in 36 monthly installments with an interest rate of 1% per year, commencing on January 10, 2013 and ending on December 10, 2015.

On May 1, 2015, we redeemed 200,000 shares of our old Class B Common Stock held by Upali Fonseka, one of our holders of more than 5% of our outstanding capital stock, for an aggregate purchase price of \$711,000.00, payable in 12 equal quarterly installments with an interest rate of 1% per year, commencing on August 1, 2015 and ending on May 1, 2018.

On January 1, 2016, we redeemed 175,200 shares of our old Class A Common Stock held by the Mark Kistner Trust, one of the holders of more than 5% of our outstanding capital stock, for an aggregate purchase price of \$671,892, which was paid in 12 equal monthly installments commencing on January 10, 2016.

On January 1, 2016, we redeemed 175,200 shares of our old Class A Common Stock held by George J. Christ and Deborah M. Christ, Trustees of The Christ Revocable Trust dated May 8, 2015, one of the holders of more than 5% of our outstanding capital stock, for an aggregate purchase price of \$671,892, which was paid in 12 equal monthly installments commencing on January 10, 2016.

On June 6, 2016, we redeemed 137,268 shares of our old Class B Common Stock held by Dennis Zuccaro, Trustee of the Dennis & Kathleen Zuccaro Trust dated January 19, 1987, one of the holders of more than 5% of our outstanding capital stock, for an aggregate purchase price of \$499,998.69, which was paid in two installments of \$250,000.00 and \$249,998.69, on August 1, 2016 and December 1, 2016, respectively.

On December 1, 2016, we redeemed 113,388 shares of our old Class A Common Stock held by George J. Christ and Deborah M. Christ, Trustees of The Christ Revocable Trust dated May 8, 2015, one of the holders of more than 5% of our outstanding capital stock, for an aggregate purchase price of \$540,010, which is payable in 9 equal monthly installments commencing on January 10, 2017.

On December 1, 2016, we redeemed 59,108 shares of our old Class B Common Stock held by James E. Brancheau & Paula M. Brancheau JTWROS for an aggregate purchase price of \$267,316, which is

payable in 11 installments and accrues interest at a rate of 1% per month. We paid the first installment of \$22,464 on January 10, 2017 and are paying the remainder of the purchase price, plus interest, in 10 equal monthly installments since February 10, 2017.

### **Altair Bellingham, LLC lease and acquisition**

On December 28, 2000, we signed a real estate lease with Altair Bellingham LLC, or Bellingham, a Michigan limited liability company, of which the James R. Scapa Declaration of Trust dated March 5, 1987, as amended, or the Scapa Trust, owned 39.56% of the outstanding membership interest, Mark E. Kistner owned 24.18% of the outstanding membership interest and George J. Christ owned 36.26% of the outstanding membership interest to lease the building that we use as our world headquarters in Troy Michigan. James R. Scapa, the chairman of our board of directors and our chief executive officer, is the trustee of the Scapa Trust. Mr. Kistner, and Mr. Christ are each holders of more than 5% of our outstanding capital stock. Pursuant to the terms of the lease, we paid Bellingham rent of \$577,501 and \$416,225 in each of 2014 and 2015, respectively. On October 1, 2015, we acquired 100% of the outstanding equity of Bellingham from the Scapa Trust, Mr. Kistner and Mr. Christ pursuant to a membership interest purchase agreement, or the Bellingham Purchase Agreement. On January 31, 2016, pursuant to the Bellingham Purchase Agreement, we paid the Scapa Trust, Mr. Kistner and Mr. Christ \$286,609, \$175,182 and \$262,701, respectively, as consideration for the purchase of their membership interest in Bellingham.

### **2013 credit agreement**

In 2013, we entered into a credit agreement with JP Morgan Chase Bank, N.A. pursuant to which Bellingham, was an unconditional guarantor until the agreement was amended in 2016. For more information about our credit facilities, including the 2016 Credit Agreement, see the section entitled "Management's Discussion and Analysis of Financial Condition and Results of Operations—Liquidity and capital resources—Credit facility."

### **Investments in Groupknit, Inc.**

On October 22, 2015, we acquired 5,000 shares of the common capital stock of Groupknit, Inc. a Michigan corporation, for an aggregate cash purchase price of \$80,000. As part of the same investment, our executive officers Mr. Scapa, Mr. Dagg, Mr. Mahalingam, Mr. Chouinard and Mr. Fariello acquired an aggregate of 5,000 shares in Groupknit, Inc. for an aggregate cash purchase price of \$80,000. Groupknit, Inc. also issued 15,000 shares each to two individuals in exchange for the contribution by each individual of his rights in the Groupknit Program technology and intellectual property. One such individual is the significant other of Mr. Scapa's daughter, the chief executive officer of one of our wholly-owned subsidiaries.

On December 27, 2016, we acquired an additional 2,500 shares of the common capital stock of Groupknit, Inc. for an aggregate cash purchase price of \$40,000. As part of the same investment, our executive officers, Mr. Scapa, Mr. Dagg, Mr. Mahalingam, Mr. Chouinard and Mr. Fariello, acquired an aggregate of 2,500 shares in Groupknit, Inc. for an aggregate cash purchase price of \$40,000.

### **Stock option grants to executive officers and directors**

We have granted stock options to our named executive officers and our directors. For a description of equity awards to our named executive officers, see the section entitled "Executive compensation—Outstanding equity awards at fiscal year end 2016 table."

## **Indemnification of officers and directors**

We plan to enter into indemnification agreements with each of our directors and executive officers prior to the completion of the offering. The indemnification agreements and our Delaware certificate of incorporation and bylaws will require us to indemnify our directors and executive officers to the fullest extent permitted by Delaware law. See the sections entitled "Management" and "Executive compensation" above.

## **Policies and procedures for related-party transactions**

Our audit committee has the primary responsibility for the review, approval and oversight of any "related party transaction," which is any transaction, arrangement, or relationship (or series of similar transactions, arrangements, or relationships) in which we are, were, or will be a participant and the amount involved exceeds \$120,000, and in which the related person has, had, or will have a direct or indirect material interest. Under our related party transaction policy, our management will be required to submit any related person transaction not previously approved or ratified by our audit committee to our audit committee. In approving or rejecting the proposed transactions, our audit committee will take into account all of the relevant facts and circumstances available.

## Principal and selling stockholders

The following table sets forth certain information with respect to the beneficial ownership of our common stock as of September 25, 2017, after giving effect to the automatic conversion, pursuant to the Recapitalization on April 3, 2017, of all outstanding shares of our old Class A common stock and our old Class B common stock into Class B common stock and Class A common stock, respectively, and as adjusted to reflect the shares of Class A common stock to be issued and sold in the offering, assuming no exercise of the underwriters' over-allotment option, by:

- each person or group of affiliated persons known by us to be the beneficial owner of more than 5% of our common stock;
- each of our current directors;
- each of our named executive officers;
- all executive officers and directors as a group; and
- the selling stockholders.

The amounts and percentage of shares of common stock beneficially owned are reported on the basis of regulations of the SEC governing the determination of beneficial ownership of securities. Under the rules of the SEC, a person is deemed to be a "beneficial owner" of a security if that person has or shares "voting power," which includes the power to vote or to direct the voting of such security, or "investment power," which includes the power to dispose of or to direct the disposition of such security. In computing the number of shares beneficially owned by a person and the percentage ownership of that person, common stock subject to options held by that person that are currently exercisable or exercisable within 60 days of the date of this prospectus, if any, are deemed outstanding, but are not deemed outstanding for computing the percentage ownership of any other person. Except as indicated by footnote, the persons named in the table below have sole voting and investment power with respect to all shares of common stock shown as beneficially owned by them, subject to community property laws where applicable.

The percentages reflect beneficial ownership immediately prior to and immediately after the completion of this offering as determined in accordance with Rule 13d-3 under the Exchange Act and are based on 9,387,712 shares of our Class A common stock and 41,203,428 shares of our Class B common stock outstanding as of September 25, 2017 and assumes there are \_\_\_\_\_ shares of our common stock outstanding as of the date immediately following the completion of this offering, assuming no exercise by the underwriters of their option to purchase additional shares of our common stock, and there are \_\_\_\_\_ shares of our common stock outstanding as of the date immediately following the completion of this offering, assuming full exercise by the underwriters of their option to purchase additional shares of our common stock. Except as noted below, the address for all beneficial owners in the table below is c/o Altair Engineering Inc. at 1820 E Big Beaver Rd, Troy MI 48083.



# Principal and selling stockholders

Name of Beneficial Owner	Beneficial Ownership of Common Stock Prior to the Offering					Beneficial Ownership of Common Stock After the Offering					
	Class A		Class B		% of Total Voting Power (Pre-Offering)	Class A Shares Being Offered	Class A		Class B		% of Total Voting Power (Post-Offering)
	Shares	%	Shares	%			Shares	%	Shares	%	
<b>Selling Stockholders and other 5% Stock holders:</b>											
James R. Scapa <sup>(1)</sup>	1,734,996	15.60%	20,075,420	48.72%	47.85%						
George J. Christ <sup>(2)</sup>	—	—	15,770,732	38.28%	37.42%						
Mark E. Kistner	—	—	2,861,524	6.94%	6.79%						
Dennis Zuccaro <sup>(3)</sup>	1,062,732	11.32%	—	—	*						
G. Upali Fonseka	1,259,108	13.41%	—	—	*						
John Brink <sup>(4)</sup>	1,475,108	13.64%	—	—	*						
Regu Ramoo <sup>(5)</sup>	1,475,108	13.60%	—	—	*						
Robert B. Little <sup>(6)</sup>	1,476,764	15.73%	—	—	*						
Michael White <sup>(7)</sup>	737,552	7.28%	—	—	*						
<b>Executive Officers and Directors</b>											
Brett Chouinard <sup>(8)</sup>	116,544	1.24%	16,000	*	*						*
Howard N. Morof <sup>(9)</sup>	703,456	7.17%	—	—	*						
Massimo Fariello <sup>(10)</sup>	64,152	*	332,000	*	*			*			*
James P. Dagg <sup>(11)</sup>	738,504	7.29%	—	—	*						
Dr. Uwe Schramm <sup>(12)</sup>	94,560	1.01%	—	—	*						*
Mahalingam Srikanth <sup>(13)</sup>	43,736	*	—	—	*			*			
Jeffrey M. Brennan <sup>(14)</sup>	237,656	2.48%	16,000	*	*						*
Martin Nichols <sup>(15)</sup>	90,424	*	4,000	*	*						*
Tom M. Perring <sup>(16)</sup>	465,664	4.96%	20,000	*	*						*
Nelson Dias <sup>(17)</sup>	39,672	*	—	—	*						
James E. Brancheau <sup>(18)</sup>	1,263,168	13.45%	—	—	*						
Steve Earhart <sup>(19)</sup>	40,000	*	—	—	*			*			
Jan Kowal <sup>(20)</sup>	20,000	*	—	—	*			*			
Trace Harris <sup>(21)</sup>	10,000	—	—	—	*			*			
Richard Hart <sup>(22)</sup>	—	—	—	—	—			—			—
All executive officers and directors as a group (16 individuals) <sup>(23)</sup>	5,662,532	44.67%	20,463,420	49.66%	49.52%	—					

(\*) Represents beneficial ownership of less than 1%

- (1) Consists of (i) 12,651,416 shares of Class B common stock held of record by Mr. Scapa as trustee of the James R. Scapa Declaration of Trust dated March 5, 1987, and (ii) 7,424,004 shares of Class B common stock held of record by JRS Investments, LLC. Mr. Scapa is the manager of JRS Investments, LLC and has voting and investment power over the securities held by JRS Investments, LLC. Mr. Scapa also holds 1,734,996 shares subject to options exercisable for Class A common stock within 60 days of the date of this prospectus, all of which are vested as of such date. Excludes 120,000 shares subject to options which vest subject to time-based vesting conditions that will not be satisfied within 60 days of the date of this prospectus.
- (2) Consists of (i) 9,346,728 shares of Class B common stock held of record by George J. Christ and Deborah M. Christ, as trustees of the Christ Revocable Trust dated May 8, 2015, and (ii) 6,424,004 shares of Class B common stock held of record by GC Investments, LLC. Mr. Christ is the manager of GC Investments, LLC and has voting and investment power over the securities held by GC Investments, LLC.
- (3) Consists of 1,062,732 shares of Class A common stock held of record by Dennis Zuccaro as trustee of the Dennis and Kathleen Zuccaro Trust dated January 19, 1987.
- (4) Consists of 1,423,108 shares subject to options exercisable for Class A common stock within 60 days of the date of this prospectus, all of which are vested as of such date.
- (5) Consists of 1,455,108 shares subject to options exercisable for Class A common stock within 60 days of the date of this prospectus, all of which are vested as of such date.
- (6) Consists of 1,656 shares subject to options exercisable for Class A common stock within 60 days of the date of this prospectus, all of which are vested as of such date. Excludes 3,384 shares subject to options which vest subject to time-based vesting conditions that will not be satisfied within 60 days of the date of this prospectus.
- (7) Consists of 737,552 shares subject to options exercisable for Class A common stock within 60 days of the date of this prospectus, all of which are vested as of such date.

## Table of Contents

- (8) Consists of 15,500 shares subject to options exercisable for Class A common stock within 60 days of the date of this prospectus, all of which are vested as of such date. Excludes 58,784 options which vest subject to time-based vesting conditions that will not be satisfied within 60 days of the date of this prospectus.
- (9) Consists of (i) 140,000 shares of Class A common stock held of record by Mr. Morof as trustee of the Howard N. Morof Revocable Trust dated August 7, 1992, (ii) 141,080 shares of Class A common stock held of record by Mr. Morof as trustee of the Howard N. Morof Irrevocable Grantor Trust dated September 11, 2017 and (iii) 422,376 shares subject to options exercisable for Class A common stock within 60 days of the date of this prospectus, all of which are vested as of such date. Excludes 34,124 options which vest subject to time-based vesting conditions that will not be satisfied within 60 days of the date of this prospectus.
- (10) Consists of (i) 332,000 shares of Class B common stock held of record by Advanced Studies Holding Future Srl, an Italian Company, and (ii) 64,152 shares subject to options exercisable for Class A within 60 days of the date of this prospectus, all of which are vested as of such date. Excludes 26,156 options which vest subject to time-based vesting conditions that will not be satisfied within 60 days of the date of this prospectus.
- (11) Consists of 738,504 shares subject to options exercisable for Class A common stock within 60 days of the date of this prospectus, all of which are vested as of such date. Excludes 22,132 options which vest subject to time-based vesting conditions that will not be satisfied within 60 days of the date of this prospectus.
- (12) Consists of 8,560 shares subject to options exercisable for Class A common stock within 60 days of the date of this prospectus, all of which are vested as of such date. Excludes 47,380 options which vest subject to time-based vesting conditions that will not be satisfied within 60 days of the date of this prospectus.
- (13) Consists of 43,736 shares subject to options exercisable for Class A common stock within 60 days of the date of this prospectus, all of which are vested as of such date. Excludes 46,372 options which vest subject to time-based vesting conditions that will not be satisfied within 60 days of the date of this prospectus.
- (14) Consists of 194,876 shares subject to options exercisable for Class A common stock within 60 days of the date of this prospectus, all of which are vested as of such date. Excludes 9,908 options which vest subject to time-based vesting conditions that will not be satisfied within 60 days of the date of this prospectus.
- (15) Consists of 4,424 shares subject to options exercisable for Class A common stock within 60 days of the date of this prospectus, all of which are vested as of such date. Excludes 29,088 options which vest subject to time-based vesting conditions that will not be satisfied within 60 days of the date of this prospectus.
- (16) Consists of 9,276 shares subject to options exercisable for Class A common stock within 60 days of the date of this prospectus, all of which are vested as of such date. Excludes 9,708 options which vest subject to time-based vesting conditions that will not be satisfied within 60 days of the date of this prospectus.
- (17) Consists of 19,672 shares subject to options exercisable for Class A common stock within 60 days of the date of this prospectus, all of which are vested as of such date. Excludes 4,960 options which vest subject to time-based vesting conditions that will not be satisfied within 60 days of the date of this prospectus.
- (18) Consists of 3,168 shares subject to options exercisable for Class A common stock within 60 days of the date of this prospectus, all of which are vested as of such date.
- (19) Excludes 4,000 options which vest subject to time-based vesting conditions that will not be satisfied within 60 days of the date of this prospectus.
- (20) Consists of 20,000 shares subject to options exercisable for Class A common stock within 60 days of the date of this prospectus, all of which are vested as of such date. Excludes 4,000 options which vest subject to time-based vesting conditions that will not be satisfied within 60 days of the date of this prospectus.
- (21) Consists of 10,000 shares subject to options exercisable for Class A common stock within 60 days of the date of this prospectus, all of which will vest on November 23, 2017. Excludes 14,000 options which vest subject to time-based vesting conditions that will not be satisfied within 60 days of the date of this prospectus.
- (22) Excludes 24,000 options which vest subject to time-based vesting conditions that will not be satisfied within 60 days of the date of this prospectus.
- (23) Total includes all individuals listed under the heading "Executive Officers and Directors" and, James R. Scapa, our chairman and chief executive officer. Consists of (i) 2,373,292 shares of Class A common stock beneficially owned by our executive officers and directors, and not subject to our right of repurchase upon completion of this offering (ii) 20,463,420 shares of Class B common stock beneficially owned by our executive officers and directors and not subject to our right of repurchase upon completion of this offering, and (iii) 3,289,240 shares subject to options exercisable for Class A common stock within 60 days of the date of this prospectus, 3,279,240 of which are vested as of such date 10,000 of which will vest on November 23, 2017. Excludes 454,596 options which vest subject to time based vesting conditions that will not be satisfied within 60 days of the date of this prospectus.

## Description of capital stock

### General

The following is a summary of the rights of our Class A and Class B common stock and preferred stock and certain provisions of our Delaware certificate of incorporation and bylaws. This summary does not purport to be complete and is qualified in its entirety by the provisions of our Delaware certificate of incorporation and bylaws, copies of which have been filed as exhibits to the registration statement of which this prospectus is a part.

Immediately following the completion of this offering, our authorized capital stock will consist of 6,000,000 shares, with a par value of \$0.0001 per share, of which:

- 513,796,572 shares are designated as Class A common stock;
- 41,203,428 shares are designated as Class B common stock; and
- 45,000,000 shares are designated as preferred stock.

Our board of directors is authorized, without stockholder approval, except as required by the listing standards of the Nasdaq Global Select Market, to issue additional shares of our capital stock.

As of June 30, 2017, we had 9,387,512 shares of our Class A common stock and 41,203,428 shares of our Class B common stock outstanding, held by approximately 475 stockholders of record and no shares of preferred stock outstanding.

### Class A and Class B common stock

We have two classes of common stock—Class A common stock entitled to one vote per share and Class B common stock entitled to 10 votes per share.

#### *Voting rights*

Holders of our Class A common stock and Class B common stock upon completion of this offering will have identical rights, provided however that, except as otherwise expressly provided in our Delaware certificate of incorporation or required by applicable law, on any matter that is submitted to a vote of our stockholders, holders of Class A common stock are entitled to one vote per share of Class A common stock and holders of Class B common stock are entitled to 10 votes per share of Class B common stock. Holders of shares of Class A common stock and Class B common stock vote together as a single class on all matters (including the election of directors) submitted to a vote of stockholders, unless otherwise required by Delaware law or our Delaware certificate of incorporation. Delaware law could require either holders of our Class A common stock or Class B common stock to vote separately as a single class in the following circumstances:

- if we were to seek to amend our Delaware certificate of incorporation to increase or decrease the par value of a class of our capital stock, then that class would be required to vote separately to approve the proposed amendment; and
- if we were to seek to amend our Delaware certificate of incorporation in a manner that alters or changes the powers, preferences or special rights of a class of our capital stock in a manner that affected its holders adversely, then that class would be required to vote separately to approve the proposed amendment.

## [Table of Contents](#)

Under our Delaware certificate of incorporation, we may not issue any shares of Class B common stock, other than those shares issuable upon exercise of options, warrants, or similar rights to acquire Class B common stock outstanding immediately prior to the completion of the offering and in connection with stock dividends, unless that issuance is approved by the affirmative vote of the holders of a majority of the outstanding shares of Class A common stock and Class B common stock, each voting separately as a class.

We have not provided for cumulative voting for the election of directors in our Delaware certificate of incorporation. Our Delaware certificate of incorporation and bylaws provide for a classified board of directors consisting of three classes of approximately equal size, each class serving staggered three-year terms. Only one class will be elected at each annual meeting of our stockholders, with the other classes continuing for the remainder of their respective three-year terms.

### ***No preemptive or similar rights***

Our classes of common stock are not entitled to preemptive rights and are not subject to conversion, redemption or sinking fund provisions.

### ***Economic rights***

Except as otherwise expressly provided in our Delaware certificate of incorporation or required by applicable law, shares of Class A common stock and Class B common stock have the same rights and privileges and rank equally, share ratably and are identical in all respects as to all matters, including, without limitation those described below.

### ***Dividends and distributions***

Subject to preferences that may apply to any shares of preferred stock outstanding at the time, the holders of Class A common stock and Class B common stock are entitled to share equally, identically and ratably, on a per share basis, with respect to any dividend or distribution of cash, property or shares of our capital stock paid or distributed by us, unless different treatment of the shares of each such class is approved by the affirmative vote of the holders of a majority of the outstanding shares of Class A common stock and Class B common stock, each voting separately as a class. In the event a dividend or distribution is paid in the form of shares of Class A common stock or Class B common stock or rights to acquire shares of such stock, the holders of Class A common stock shall receive Class A common stock, or rights to acquire Class A common stock, as the case may be, and the holders of Class B common stock shall receive Class B common stock, or rights to acquire Class B common stock, as the case may be.

### ***Liquidation rights***

Upon our liquidation, dissolution or winding-up, the holders of Class A common stock and Class B common stock are entitled to share equally, identically and ratably in all assets remaining after the payment of any liabilities and the liquidation preferences and any accrued or declared but unpaid dividends, if any, with respect to any outstanding preferred stock, unless different treatment of the shares of each class is approved by the affirmative vote of the holders of a majority of the outstanding shares of Class A common stock and Class B common stock, each voting separately as a class.

### ***Change of control transactions***

Upon (A) the closing of the sale, transfer or other disposition of all or substantially all of our assets, (B) the consummation of a merger, consolidation, business combination or share transfer which results in our voting

## [Table of Contents](#)

securities outstanding immediately prior to the transaction (or the voting securities issued with respect to our voting securities outstanding immediately prior to the transaction) representing less than a majority of the combined voting power of our voting securities or the voting securities of the surviving or acquiring entity, (C) the closing of the transfer (whether by merger, consolidation or otherwise), in one transaction or a series of related transactions, to a person or group of affiliated persons of securities of the Company if, after closing, the transferee person or group would hold 50% or more of our outstanding voting stock (or the outstanding voting stock of the surviving or acquiring entity), (D) any voluntary or involuntary recapitalization, liquidation, dissolution or winding-up, or (E) the issuance by us of voting securities representing more than 2% of our total voting power to a person who held 50% or less of our total voting power immediately prior to such transaction and who following such transaction holds more than 50% of our total voting power, the holders of Class A common stock and Class B common stock will be treated equally and identically with respect to shares of Class A common stock or Class B common stock owned by them, unless different treatment of the shares of each class is approved by the affirmative vote of the holders of a majority of the outstanding shares of Class A common stock and Class B common stock, each voting separately as a class.

### ***Subdivisions and combinations***

If we subdivide or combine in any manner outstanding shares of Class A common stock or Class B common stock, the outstanding shares of the other class will be subdivided or combined in the same manner, unless different treatment of the shares of each class is approved by the affirmative vote of the holders of a majority of the outstanding shares of Class A common stock and Class B common stock, each voting as a separate class.

### ***Conversion***

Each share of our Class B common stock is automatically convertible into one share of our Class A common stock pursuant to the terms of our Delaware certificate of incorporation upon the occurrence of certain events. With respect to all beneficial owners, as defined in our Delaware certificate of incorporation, of Class B common stock, each share of Class B common stock will convert automatically into one share of Class A common stock upon (i) the date specified by affirmative vote of the holders of at least 66-2/3% of the outstanding shares of Class B common stock, (ii) the executive holder, as defined in our Delaware certificate of incorporation, is neither (x) an executive officer of the company nor (y) a director of the company, (iii) the date on which the executive has beneficial ownership of less than 10% of the capital stock of the company, or (iv) the 12 year anniversary of the date of filing of our Delaware certificate of incorporation in connection with this offering.

With respect to each individual beneficial owner of Class B common stock, each share of Class B common stock held by a beneficial owner will convert automatically into one share of Class A common stock (i) at any time at the option of such owner, (ii) upon any transfer, whether or not for value, except for certain transfers described in our Delaware certificate of incorporation, including, without limitation, transfers from a founder, as defined in our Delaware certificate, to another founder, or certain permitted transferees, or (iii) in the event any beneficial owner owns shares of Class B common stock constituting less than 3% of the outstanding shares of Class B common stock.

Each share of Class B common stock held by all beneficial owners of Class B common stock, except the executive holder, will convert automatically into one share of Class A common stock in the event the key holders, as defined in our Delaware certificate of incorporation, beneficially own, in the aggregate, more shares of Class B common stock than the executive holder in which event the only holder of Class B common stock will be the executive holder.

In addition, upon the death or incapacity of a beneficial owner of Class B common stock, other than the executive holder, each share of Class B common stock held by such beneficial owner will convert automatically

into one share of Class A common stock, immediately upon such death or incapacity, except, with respect to the key holders, such automatic conversion will occur on the date which is nine (9) months after the date of such death or incapacity. Upon the death or incapacity of the executive holder, each share of Class B common stock held by all beneficial owners of Class B common stock will convert automatically into one share of Class A common stock on the date which is nine (9) months after the date of such death or incapacity.

## **Preferred stock**

After the completion of this offering, no shares of preferred stock will be outstanding. Pursuant to our Delaware certificate of incorporation, our board of directors will have the authority, without further action by the stockholders, to issue from time to time up to 45,000,000 shares of preferred stock in one or more series. Our board of directors may designate the rights, preferences, privileges and restrictions of the preferred stock, including dividend rights, conversion rights, voting rights, redemption rights, liquidation preference, sinking fund terms and the number of shares constituting any series or the designation of any series. The issuance of preferred stock could have the effect of restricting dividends on the Class A and Class B common stock, diluting the voting power of the Class A and Class B common stock, impairing the liquidation rights of the Class A and Class B common stock or delaying, deterring or preventing a change in control. Such issuance could have the effect of decreasing the market price of the Class A and Class B common stock. We currently have no plans to issue any shares of preferred stock.

## **Option awards**

As of June 30, 2017, we had outstanding options to purchase an aggregate of 11,488,828 shares of our Class A common stock pursuant to our 2001 NQSO Plan, 2001 ISO and NQSO Plan and 2012 Plan, with weighted-average exercise prices of \$0.00, \$0.64, and \$3.73, respectively. We do not have any issued and outstanding options exercisable for any shares of our Class B common stock.

## **Anti-takeover effects of Delaware law and our certificate of incorporation and bylaws**

Our Delaware certificate of incorporation and bylaws contain provisions that could have the effect of delaying, deferring or discouraging another party from acquiring control of us. These provisions and certain provisions of Delaware law, which are summarized below, could discourage takeovers, coercive or otherwise. These provisions are also designed, in part, to encourage persons seeking to acquire control of us to negotiate first with our board of directors. We believe that the benefits of increased protection of our potential ability to negotiate with an unfriendly or unsolicited acquirer outweigh the disadvantages of discouraging a proposal to acquire us.

**Dual class stock.** As described above under the heading “Description of capital stock—Class A and Class B common stock—Voting rights,” our Delaware certificate of incorporation provides for a dual class common stock structure, which will provide our founders and certain others with significant influence over all matters requiring stockholder approval, including the election of directors and significant corporate transactions, such as a merger or other sale of our company or its assets.

**Issuance of undesignated preferred stock.** As discussed above under the heading “Description of capital stock—Preferred stock,” our board of directors have the ability to designate and issue preferred stock with voting or other rights or preferences that could deter hostile takeovers or delay changes in our control or management.

**Limits on ability of stockholders to act by written consent or call a special meeting.** Our Delaware certificate of incorporation provides that our stockholders may not act by written consent. This limit on the ability of stockholders to act by written consent may lengthen the amount of time required to take stockholder actions. As a result, the holders of a majority of our capital stock are not able to amend the bylaws or remove directors without holding a meeting of stockholders called in accordance with the bylaws.

In addition, our bylaws provide that special meetings of the stockholders may be called only by the chairman of our board of directors, the chief executive officer, the president (in the absence of a chief executive officer) or a majority of our board of directors. A stockholder may not call a special meeting, which may delay the ability of our stockholders to force consideration of a proposal or for holders controlling a majority of our capital stock to take any action, including the removal of directors.

**Requirements for advance notification of stockholder nominations and proposals.** Our bylaws provide advance notice procedures with respect to stockholder proposals and the nomination of candidates for election as directors, other than nominations made by or at the direction of our board of directors or a committee of the board of directors. These advance notice procedures may have the effect of precluding the conduct of certain business at a meeting if the proper procedures are not followed and may also discourage or deter a potential acquirer from conducting a solicitation of proxies to elect its own slate of directors or otherwise attempt to obtain control of our company.

**Board classification.** Our Delaware certificate of incorporation provides that our board of directors will be divided into three classes, one class of which is elected each year by our stockholders. The directors in each class will serve for a three-year term. For more information on the classified board of directors, see the section entitled “Management—Board composition.” Our classified board of directors may tend to discourage a third party from making a tender offer or otherwise attempting to obtain control of us because it generally makes it more difficult for stockholders to replace a majority of the directors.

**Election and removal of directors.** Our certificate of incorporation and bylaws contain provisions that establish specific procedures for appointing and removing members of our board of directors. Under our certificate of incorporation and bylaws, vacancies and newly created directorships on our board of directors may be filled only by a majority of the directors then serving on our board of directors. Under our certificate of incorporation and bylaws, directors may be removed only for cause.

**No cumulative voting.** The Delaware General Corporation Law provides that stockholders are not entitled to the right to cumulative votes in the election of directors unless our certificate of incorporation provides otherwise. Our certificate of incorporation and bylaws do not expressly provide for cumulative voting. Without cumulative voting, a minority stockholder may not be able to gain as many seats on our board of directors as the stockholder would be able to gain if cumulative voting were permitted. The absence of cumulative voting makes it more difficult for a minority stockholder to gain a seat on our board of directors to influence our board of directors’ decision regarding a takeover.

**Amendment of charter provision.** Any amendment of the above provisions in our certificate of incorporation would require approval by holders of at least two-thirds of our then outstanding Class A and Class B common stock, voting together as a single class.

**Delaware anti-takeover statute.** We are subject to the provisions of Section 203 of the Delaware General Corporation Law regulating corporate takeovers. In general, Section 203 prohibits a publicly held Delaware corporation from engaging, under certain circumstances, in a business combination with an interested stockholder for a period of three years following the date the person became an interested stockholder unless:

- prior to the date of the transaction, our board of directors approved either the business combination or the transaction that resulted in the stockholder becoming an interested stockholder;

## [Table of Contents](#)

- upon completion of the transaction that resulted in the stockholder becoming an interested stockholder, the interested stockholder owned at least 85% of the voting stock of the corporation outstanding at the time the transaction commenced, excluding for purposes of determining the voting stock outstanding, but not the outstanding voting stock owned by the interested stockholder, (1) shares owned by persons who are directors and also officers and (2) shares owned by employee stock plans in which employee participants do not have the right to determine confidentially whether shares held subject to the plan will be tendered in a tender or exchange offer; or
- at or subsequent to the date of the transaction, the business combination is approved by our board of directors and authorized at an annual or special meeting of stockholders, and not by written consent, by the affirmative vote of at least two-thirds of the outstanding voting stock that is not owned by the interested stockholder.

Generally, a business combination includes a merger, asset or stock sale, or other transaction resulting in a financial benefit to the interested stockholder. An interested stockholder is a person who, together with affiliates and associates, owns or, within three years prior to the determination of interested stockholder status, did own 15% or more of a corporation's outstanding voting stock. We expect the existence of this provision to have an anti-takeover effect with respect to transactions our board of directors does not approve in advance. We also anticipate that Section 203 may discourage attempts that might result in a premium over the market price for the shares of Class A common stock held by stockholders.

The provisions of Delaware law and the provisions of our certificate of incorporation and bylaws could have the effect of discouraging others from attempting hostile takeovers and as a consequence, they might also inhibit temporary fluctuations in the market price of our Class A common stock that often result from actual or rumored hostile takeover attempts. These provisions might also have the effect of preventing changes in our management. It is also possible that these provisions could make it more difficult to accomplish transactions that stockholders might otherwise deem to be in their best interests.

## **Transfer agent and registrar**

Upon the completion of this offering, the transfer agent and registrar for our common stock will be American Stock Transfer & Trust Company, LLC. The transfer agent's address is Operations Center 6201 15th Avenue Brooklyn, NY 11219, and its telephone number is (800) 937-5449.

## **Exchange listing**

We have applied to list our Class A common stock on the Nasdaq Global Select Market under the symbol "ALTR."



## Shares eligible for future sale

Prior to this offering, there has been no public market for our common stock. Future sales of our Class A common stock in the public market, or the availability of such shares for sale in the public market, could adversely affect the market price of our Class A common stock prevailing from time to time. As described below, only a limited number of Class A shares will be available for sale shortly after this offering due to contractual and legal restrictions on resale. Nevertheless, sales of a substantial number of shares of our Class A common stock in the public market after such restrictions lapse, or the perception that those sales may occur, could adversely affect the prevailing market price of our Class A common stock at such time and our ability to raise equity-related capital at a time and price we deem appropriate.

### Sales of restricted shares

Upon completion of this offering, we will have outstanding an aggregate of \_\_\_\_\_ shares of Class A common stock and \_\_\_\_\_ shares of Class B common stock. Of these shares, all of the \_\_\_\_\_ shares of Class A common stock to be sold in this offering (or \_\_\_\_\_ shares assuming the underwriters exercise the option to purchase additional shares in full) will be freely tradable without restriction or further registration under the Securities Act, unless the shares are held by any of our “affiliates” as such term is defined in Rule 144 under the Securities Act. All remaining shares of Class A and Class B common stock will be deemed “restricted securities” as such term is defined under Rule 144. The restricted securities were, or will be, issued and sold by us in private transactions and are eligible for public sale only if registered under the Securities Act or if they qualify for an exemption from registration under Rule 144 or Rule 701 under the Securities Act, which rules are summarized below.

As a result of the lock-up agreements described below and the provisions of Rule 144 and Rule 701 under the Securities Act, all of the shares of our common stock (excluding the shares to be sold in this offering) will be available for sale in the public market upon the expiration of the lockup agreements, beginning 180 days after the date of this prospectus (subject to extension) and when permitted under Rule 144 or Rule 701, subject to the limitations set forth below.

### Lock-up agreements

We, each of our current directors, executive officers, the selling stockholders and certain of our principal stockholders, have agreed that, we and they will not, during the period ending 180 days after the date of this prospectus, except with the prior written consent of J.P. Morgan Securities LLC and RBC Capital Markets, LLC:

- offer, pledge, sell, contract to sell, sell any option or contract to purchase, purchase any option or contract to sell, grant any option, right or warrant to purchase, or otherwise transfer or dispose of, directly or indirectly, any shares of common stock or any securities convertible into or exercisable or exchangeable for shares of common stock;
- file any registration statement with the SEC relating to the offering of any shares of common stock or any securities convertible into or exercisable or exchangeable for common stock; or
- enter into any swap or other agreement that transfers to another, in whole or in part, any of the economic consequences of ownership of our common stock;

whether any such transaction described above is to be settled by delivery of shares of our common stock or such other securities, in cash or otherwise, subject to certain exceptions, as set forth in “Underwriting.”

In addition to the restrictions contained in the lock-up agreements described above, we have entered into agreements with certain security holders, including our standard form of stock purchase agreement, option agreement and restricted stock unit agreement, that contain certain market stand-off provisions imposing restrictions on the ability of such security holders to offer, sell or transfer our equity securities for a period of 180 days following the date of this prospectus.

## **Restrictions on transfer and repurchase rights**

Prior to the completion of this offering, the holders of approximately 9,107,512 shares of our Class A common stock will be subject to certain restrictions on these holders' abilities to transfer their Class A common stock without our consent pursuant to stock restriction and repurchase agreements that we have entered into with these holders. Each stock option holder who has exercised stock options granted under our 2001 NQSO Plan, 2001 ISO and NQSO Plan, and 2012 Plan has executed a stock restriction and repurchase agreement. Under each stock restriction and repurchase agreement (other than certain agreements entered into with members of our board) we have a mandatory obligation to repurchase shares received on exercise of the option in the event of breach of restrictive covenants. We have a mandatory repurchase right upon a termination for cause under each stock restriction and repurchase agreement pursuant to our 2001 NQSO Plan and our 2001 ISO and NQSO Plan, and a discretionary repurchase right upon a termination for cause under each stock restriction and repurchase agreement pursuant to our 2012 Plan, in each case, other than certain agreements entered into with members of our board. Each stock restriction and repurchase agreement under our 2001 ISO and NQSO Plan and our 2012 Plan also requires us to repurchase any shares that are unvested on the date of termination with us.

In the event of a repurchase as a result of a breach of restrictive covenants, termination for cause, or with respect to unvested shares, the repurchase price under our 2001 NQSO Plan and 2001 ISO and NQSO Plan equals the exercise price paid by the participant for the underlying shares (plus, in the case of the 2001 NQSO Plan, any amount paid by the participant in exchange for rights under our phantom equity plan), and the repurchase price under our 2012 Plan equals the lesser of (i) the exercise price paid by the participant for the underlying shares, and (ii) the fair market value per share determined as of the closing date of the repurchase. Each stock restriction and repurchase agreement also provides us with a right of first refusal and certain repurchase rights upon terminations other than for cause (other than certain agreements entered into with members of our board), each of which will terminate upon the completion of this offering.

Prior to the completion of this offering, the holders of approximately 961,548 shares of our Class A common stock will be subject to certain restrictions on these holders' abilities to transfer their Class A common stock without our consent pursuant to stock restriction and repurchase agreements that we have entered into with these holders.

Prior to the completion of this offering, the holders of approximately 2,155,248 shares of our Class B common stock will be subject to certain restrictions on these holders' abilities to transfer their Class B common stock without our consent pursuant to stock restriction and repurchase agreements that we have entered into with these holders.

Pursuant to these agreements, the holders of the shares of our common stock subject to these agreements, or the Restricted Shares, must notify us prior to transferring or selling any Restricted Shares. The notice must include the purchase price of any such proposed transfer or sale. If the proposed transfer or sale is for value, we have a right of first refusal (subject to certain exceptions for transfers related to estate planning) to purchase all of the Restricted Shares subject to the proposed transfer or sale from the holder on terms no less favorable than the terms described in the notice of proposed transfer. If we choose not to exercise our right to

## [Table of Contents](#)

repurchase the transfer restrictions on the Restricted Shares, the holder may transfer the Restricted Shares, subject to the transferee agreeing to be bound to the terms of the stock restriction and repurchase agreement.

These transfer restrictions terminate upon the earliest to occur of (i) the sale by us of all or substantially all of our capital stock (including the Restricted Shares), (ii) the date on which we consummate the sale of all or substantially all of our assets pursuant to or followed by a plan of liquidation or (iii) the date on which our capital stock (including the Restricted Shares) is first eligible and admitted for trading on any United States securities exchange or on any formal over-the-counter quotation system in general use in the United States. Following the completion of this offering and the commencement of trading of our Class A shares on the transfer restrictions on the Restricted Shares will automatically be lifted.

### **Pledged shares as collateral**

In connection with certain of our acquisitions, we issued shares of our common stock as partial acquisition consideration, the Consideration Shares. The recipients of the Consideration Shares concurrently entered into stock pledge agreements with us pursuant to which each recipient pledged its Consideration Shares as collateral to secure certain indemnification obligations of the recipient under the applicable purchase agreement. The stock pledge agreements provide that in the event the relevant holder defaults on any indemnification obligation owed to us under the applicable purchase agreement or in the performance of such stockholder's obligations under the stock pledge agreement, subject to certain conditions, we may take possession of or sell the applicable Consideration Shares for up to the fair market value of the liability we incur.

As of September 25, 2017, we have issued and outstanding an aggregate of 990,000 Consideration Shares of which 160,000 shares were released on August 17, 2017, 50,000 shares will be released on March 12, 2018, 100,000 shares will be released on March 12, 2019, 200,000 shares will be released on March 28, 2019, 280,000 shares will be released on May 5, 2020 and 200,000 shares will be released on September 28, 2020.

### **Rule 144**

In general, under Rule 144 as currently in effect, once we have been subject to public company reporting requirements for at least 90 days, a person who is not deemed to have been one of our affiliates for purposes of the Securities Act at any time during 90 days preceding a sale and who has beneficially owned the shares proposed to be sold for at least six months, including the holding period of any prior owner other than our affiliates, is entitled to sell such shares without complying with the manner of sale, volume limitation or notice provisions of Rule 144, subject to compliance with the public information requirements of Rule 144. If such a person has beneficially owned the shares proposed to be sold for at least one year, including the holding period of any prior owner other than our affiliates, then such person is entitled to sell such shares without complying with any of the requirements of Rule 144.

In general, under Rule 144, as currently in effect, our affiliates or persons selling shares on behalf of our affiliates are entitled to sell upon expiration of the lock-up agreements described above, within any three-month period beginning 90 days after the date of this prospectus, a number of shares that does not exceed the greater of:

- 1% of the number of shares of Class A common stock then outstanding, which will equal approximately \_\_\_\_\_ shares immediately after this offering; or
- the average weekly trading volume of the Class A common stock during the four calendar weeks preceding the filing of a notice on Form 144 with respect to such sale.

Sales under Rule 144 by our affiliates or persons selling shares on behalf of our affiliates are also subject to certain manner of sale provisions and notice requirements and to the availability of current public information about us.

## **Rule 701**

Rule 701 generally allows a stockholder who purchased shares of our Class A common stock pursuant to a written compensatory plan or contract and who is not deemed to have been an affiliate of our company during the immediately preceding 90 days to sell these shares in reliance upon Rule 144, but without being required to comply with the public information, holding period, volume limitation or notice provisions of Rule 144. Rule 701 also permits affiliates of our company to sell their Rule 701 shares under Rule 144 without complying with the holding period requirements of Rule 144. All holders of Rule 701 shares, however, are required to wait until 90 days after the date of this prospectus before selling such shares pursuant to Rule 701.

## **Stock issued under employee benefit plans**

We intend to file a registration statement on Form S-8 under the Securities Act covering all of the shares of our common stock subject to options outstanding or reserved for issuance under our equity plans. We expect to file this registration statement as soon as practicable after the completion of this offering. This registration statement will become effective immediately upon filing, and shares covered by this registration statement will thereupon be eligible for sale in the public markets, subject to vesting restrictions, the terms of the applicable stock restriction agreement, the lock-up agreements described above and Rule 144 limitations applicable to affiliates. For a more complete discussion of our stock plans, see the section entitled "Executive compensation—Employee benefit and equity compensation plans."

## Material United States federal income tax consequences to non-U.S. holders of our Class A common stock

The following is a summary of the material United States federal income tax consequences to non-U.S. holders (as defined below) of their ownership and disposition of our Class A common stock, but does not purport to be a complete analysis of all the potential tax considerations relating thereto. This summary is based upon current provisions of the Code, existing and proposed United States Treasury Regulations promulgated thereunder, current administrative rulings, and judicial decisions, all as in effect as of the date hereof. Especially in light of recent legislative proposals, these authorities may be changed, possibly retroactively, so as to result in United States federal tax consequences different from those set forth below. We have not obtained, and do not intend to obtain, any opinion of counsel or ruling from the Internal Revenue Service, or the IRS, with respect to the statements made and the conclusions reached in the following summary, and there can be no assurance that the IRS will agree with such statements and conclusions.

This summary also does not address the tax considerations arising under the laws of any non-United States, state or local jurisdiction or under any non-income tax laws, including United States federal gift and estate tax laws, except to the limited extent set forth below. In addition, this discussion does not address the potential application of the tax on net investment income or the alternative minimum tax. This discussion may not apply, in whole or in part, to particular non-U.S. holders in light of their individual circumstances or to holders subject to special treatment under the United States federal income tax laws, including, without limitation:

- insurance companies, banks or other financial institutions;
- tax-exempt organizations;
- pension plans;
- controlled foreign corporations or passive foreign investment companies;
- brokers or dealers in securities or currencies;
- traders in securities that elect to use a mark-to-market method of accounting for their securities holdings;
- persons that own, or are deemed to own, more than 5% of our capital stock (except to the extent specifically set forth below);
- certain former citizens or long-term residents of the United States;
- persons that hold our Class A common stock as a position in a hedging transaction, straddle, conversion transaction, synthetic security or other integrated investment;
- persons that hold or receive our Class A common stock pursuant to the exercise of any employee stock option or otherwise as compensation; and
- persons that do not hold our Class A common stock as a capital asset within the meaning of Section 1221 of the Code.

In addition, this discussion does not address the tax treatment of partnerships, including any entity or arrangement treated as a partnership for United States federal income tax purposes. Generally, the tax treatment of a person treated as a partner in such an entity will depend on the status of the partner, the activities of the partner and the partnership, and certain determinations made at the partner level. Accordingly, partnerships that hold our Class A common stock, and partners in such partnerships, should consult their tax advisors.

## Non-U.S. holder defined

For purposes of this discussion, you are a non-U.S. holder if you are a beneficial owner of our Class A common stock that is not, for United States federal income tax purposes:

- an individual citizen or resident of the United States;
- a corporation, or other entity taxable as a corporation, created or organized in the United States or under the laws of the United States or any political subdivision thereof;
- an estate whose income is subject to United States federal income tax regardless of its source; or
- a trust whose administration is subject to the primary supervision of a United States court and which has one or more “United States persons” (as defined in the Code) who have the authority to control all substantial decisions of the trust, or which has made a valid election to be treated as a United States person.

## Distributions to non-U.S. holders

As described in the section titled “Dividend Policy,” we do not anticipate paying any cash dividends or making distributions of other property on our Class A common stock in the foreseeable future. However, if we do make distributions of cash or property on our Class A common stock, those payments will constitute dividends for United States tax purposes to the extent paid from our current or accumulated earnings and profits, as determined under United States federal income tax principles. To the extent those distributions exceed both our current and our accumulated earnings and profits, the excess will constitute a return of capital and will first reduce a non-U.S. holder’s tax basis in our Class A common stock, but not below zero, and then will be treated by a non-U.S. holder as gain from the sale of stock as described below under “Material United States federal income tax consequences to non-U.S. holders of our Class A common stock—Gain on dispositions of our Class A common stock by non-U.S. holders.”

Subject to the discussion below on effectively connected income, any dividend paid to a non-U.S. holder generally will be subject to United States withholding tax either at a rate of 30% of the gross amount of the dividend or such lower rate as may be specified by an applicable income tax treaty. To receive a reduced treaty rate, a non-U.S. holder must provide us with an IRS Form W-8BEN or W-8BEN-E (or applicable successor form) and certify qualification for the reduced rate. If a non-U.S. holder is eligible for a reduced rate of United States withholding tax pursuant to an income tax treaty, such non-U.S. holder may obtain a refund or credit of any excess amounts withheld by timely filing an appropriate claim with the IRS. If a non-U.S. holder holds our Class A common stock through a financial institution or other agent acting on such non-U.S. holder’s behalf, appropriate documentation will need to be provided to the agent, which then will be required to provide certification to us or our paying agent, either directly or through other intermediaries.

Dividends received by a non-U.S. holder that are effectively connected with such non-U.S. holder’s conduct of a trade or business in the United States (and, if an applicable income tax treaty so provides, that are attributable to a permanent establishment or a fixed base maintained by such non-U.S. holder in the United States), are generally exempt from the 30% withholding tax if certain certification and disclosure requirements are satisfied. To obtain this exemption, a non-U.S. holder must provide us with an IRS Form W-8ECI (or applicable successor form) properly certifying such exemption. However, such effectively connected dividends, although not subject to withholding tax, generally are taxed at the same graduated United States federal income tax rates applicable to United States persons, net of certain deductions and credits. In addition, dividends received by a corporate non-U.S. holder that are effectively connected with the conduct of a trade or business in the United States may also be subject to a branch profits tax at a rate of 30% or such lower rate as may be specified by an applicable income tax treaty. Non-U.S. holders should consult with tax advisors regarding any applicable income tax or other treaties that may provide for different rules.

Any documentation provided to an applicable withholding agent may need to be updated in certain circumstances. The certification requirements described above also may require a non-U.S. holder to provide a United States taxpayer identification number.

For additional withholding rules that may apply to dividends, including dividends paid to foreign financial institutions (as specifically defined by the applicable rules) or to certain other foreign entities that have substantial direct or indirect United States owners, see the discussion below under “Material United States federal income tax consequences to non-U.S. holders of our Class A common stock—Backup withholding and information reporting” and “Material United States federal income tax consequences to non-U.S. holders of our Class A common stock—Withholdable payments to foreign financial institutions and other foreign entities.”

### **Gain on dispositions of our Class A common stock by non-U.S. holders**

Subject to the discussion below under “Material United States federal income tax consequences to non-U.S. holders of our Class A common stock—Backup withholding and information reporting” and “Material United States federal income tax consequences to non-U.S. holders of our Class A common stock—Withholdable payments to foreign financial institutions and other foreign entities,” a non-U.S. holder generally will not be required to pay United States federal income tax or withholding tax on any gain recognized upon the sale, exchange or other taxable disposition of our Class A common stock unless:

- the gain is effectively connected with the conduct of a trade or business by such non-U.S. holder in the United States (and, if an applicable income tax treaty so provides, the gain is attributable to a permanent establishment or a fixed base maintained by such non-U.S. holder in the United States), in which case the non-U.S. holder will be required to pay tax on the net gain derived from the sale or disposition at the graduated rates and in the manner applicable to United States persons, and an additional branch profits tax at a rate of 30% (or such lower rate as may be specified by an applicable income tax treaty) may also apply to a corporate non-U.S. holder;
- such non-U.S. holder is a nonresident alien individual who is present in the United States for a period or periods aggregating 183 days or more during the calendar year in which the sale or disposition occurs and certain other conditions are met, in which case the non-U.S. holder will be required to pay a flat 30% tax (or such lower rate as may be specified by an applicable income tax treaty) on the gain derived from the sale or disposition, which gain may be offset by United States-source capital losses for the taxable year of the sale or disposition; or
- our Class A common stock constitutes a United States real property interest by reason of our status as a “United States real property holding corporation”, or USRPHC, for United States federal income tax purposes at any time within the shorter of the five-year period preceding such non-U.S. holder’s disposition of, or holding period for, our Class A common stock, in which case the non-U.S. holder generally will be taxed on net gain derived from the sale or disposition at the graduated rates applicable to United States persons.

We believe that we are not currently and will not become a USRPHC and the remainder of this discussion so assumes. However, because the determination of whether we are a USRPHC depends on the fair market value of our United States real property relative to the fair market value of our other business assets, there can be no assurance that we will not become a USRPHC in the future. Even if we become a USRPHC, however, as long as our Class A common stock is regularly traded on an established securities market, such Class A common stock will be treated as United States real property interests only if a non-U.S. holder actually or constructively holds more than 5% of such regularly traded Class A common stock at any time during the shorter of the five-year period preceding such non-U.S. holder’s disposition of, or holding period for, our Class A common stock. Non-U.S. holders should consult with tax advisors regarding any applicable income tax or other treaties that may provide for different rules.

## **Backup withholding and information reporting**

We (or the applicable paying agent) must report annually to the IRS the amount of dividends on our Class A common stock paid to non-U.S. holders and the amount of tax withheld, if any. A similar report will be sent to each non-U.S. holder. Copies of this information reporting may also be made available under the provisions of a specific income tax treaty or agreement with the tax authorities in a non-U.S. holder's country of residence.

Non-U.S. holders will generally be subject to backup withholding (at a current rate of 28%) for dividends on our Class A common stock paid to such non-U.S. holders unless an exemption is established such as by, for example, properly certifying non-United States status on an IRS Form W-8BEN or W-8BEN-E (or applicable successor form). Notwithstanding the foregoing, backup withholding and information reporting may apply if either we or our paying agent has actual knowledge, or reason to know, that a holder of our Class A common stock is a United States person.

Information reporting and backup withholding generally are not required with respect to the amount of any proceeds from the sale or other disposition of our Class A common stock by a non-U.S. holder outside the United States through a foreign office of a foreign broker that does not have certain specified connections to the United States. However, if a non-U.S. holder sells or otherwise disposes of shares of Class A common stock through a United States broker or the United States offices of a foreign broker, the broker will generally be required to report the amount of proceeds paid to such non-U.S. holder to the IRS and also to backup withhold on that amount unless the broker is provided appropriate certification of status as a non-United States person or an exemption is otherwise established. Information reporting will also apply if a non-U.S. holder sells shares of Class A common stock through a foreign broker deriving more than a specified percentage of its income from United States sources or having certain other connections to the United States, unless such broker has documentary evidence in its records that such non-U.S. holder is a non-United States person and certain other conditions are met, or an exemption is otherwise established.

Backup withholding is not an additional tax. Any amounts withheld under the backup withholding rules from a payment may be refunded or credited against a non-U.S. holder's United States federal income tax liability, if any, provided that an appropriate claim is timely filed with the IRS. Non-U.S. holders should consult with tax advisors regarding the application of the information reporting and backup withholding rules to investment in our Class A common stock.

## **Withholdable payments to foreign financial institutions and other foreign entities**

The Foreign Account Tax Compliance Act, or FATCA, imposes a United States federal withholding tax of 30% on certain payments to "foreign financial institutions" (as specifically defined under these rules) and certain other non-United States persons that fail to comply with certain information reporting and certification requirements pertaining to their direct and indirect United States security holders and/or United States account holders. Such payments include dividends on and, on or after January 1, 2019, gross proceeds from the sale or other disposition of our Class A common stock. Under certain circumstances, a non-U.S. holder may be eligible for refunds or credits of such taxes. An intergovernmental agreement between the United States and an applicable foreign country may modify the requirements described in this paragraph. Non-U.S. holders should consult with tax advisors regarding the possible implications of this legislation and any applicable intergovernmental agreements on investment in our Class A common stock.

## **Federal estate tax**

Our Class A common stock beneficially owned by an individual who is not a citizen or resident of the United States (as defined for United States federal estate tax purposes) at the time of their death will generally



[Table of Contents](#)

be includable in the decedent's gross estate for United States federal estate tax purposes and, therefore, may be subject to United States federal estate tax unless an applicable estate tax treaty or other treaty provides otherwise. Investors are urged to consult their own tax advisors regarding the United States federal estate tax consequences of the ownership or disposition of our Class A common stock.

**THIS DISCUSSION IS NOT TAX ADVICE. NON-U.S. HOLDERS ARE URGED TO CONSULT WITH TAX ADVISORS WITH RESPECT TO THE APPLICATION OF THE UNITED STATES FEDERAL INCOME TAX LAWS TO THEIR PARTICULAR SITUATION, AS WELL AS ANY TAX CONSEQUENCES OF THE PURCHASE, OWNERSHIP AND DISPOSITION OF OUR CLASS A COMMON STOCK ARISING UNDER THE UNITED STATES FEDERAL ESTATE OR GIFT TAX RULES OR UNDER THE LAWS OF ANY STATE, LOCAL, NON-UNITED STATES OR OTHER TAXING JURISDICTION OR UNDER ANY APPLICABLE TAX TREATY, INCLUDING THE CONSEQUENCES OF ANY PROPOSED CHANGE IN APPLICABLE LAWS.**

## Underwriting

We and the selling stockholders are offering the shares of Class A common stock described in this prospectus through a number of underwriters. J.P. Morgan Securities LLC and RBC Capital Markets, LLC are acting as joint book-running managers of the offering and as representatives of the underwriters. We and the selling stockholders have entered into an underwriting agreement with the underwriters. Subject to the terms and conditions of the underwriting agreement, we and the selling stockholders have agreed to sell to the underwriters, and each underwriter has severally agreed to purchase, at the public offering price less the underwriting discounts and commissions set forth on the cover page of this prospectus, the number of shares of Class A common stock listed next to its name in the following table:

Name	Number of shares
J.P. Morgan Securities LLC	
RBC Capital Markets, LLC	
Deutsche Bank Securities Inc.	
William Blair & Company, L.L.C.	
Canaccord Genuity Inc.	
Total	

The underwriters are committed to purchase all the shares of Class A common stock offered by us and the selling stockholders if they purchase any shares. The underwriting agreement also provides that if an underwriter defaults, the purchase commitments of non-defaulting underwriters may also be increased or the offering may be terminated.

The underwriters propose to offer the shares of Class A common stock directly to the public at the initial public offering price set forth on the cover page of this prospectus and to certain dealers at that price less a concession not in excess of \$        per share. Any such dealers may resell shares to certain other brokers or dealers at a discount of up to \$        per share from the initial public offering price. After the initial offering of the shares to the public, the offering price and other selling terms may be changed by the underwriters. Sales of shares made outside of the United States may be made by affiliates of the underwriters.

The underwriters have an option to buy up to        additional shares of Class A common stock from us. The underwriters have 30 days from the date of this prospectus to exercise this option to purchase additional shares. If any shares of Class A common stock are purchased with this option to purchase additional shares, the underwriters will purchase shares of Class A common stock in approximately the same proportion as shown in the table above. If any additional shares of Class A common stock are purchased, the underwriters will offer the additional shares on the same terms as those on which the shares are being offered.

## [Table of Contents](#)

The underwriting fee is equal to the public offering price per share of Class A common stock less the amount paid by the underwriters to us per share of Class A common stock. The underwriting fee is \$        per share. The following table shows the per share and total underwriting discounts and commissions to be paid to the underwriters assuming both no exercise and full exercise of the underwriters' option to purchase additional shares of Class A common stock from us and the selling stockholders.

	<b>Without option to purchase additional shares exercise</b>	<b>With full option to purchase additional shares exercise</b>
Per Share	\$	\$
Total	\$	\$

We estimate that the total expenses of this offering, including registration, filing and listing fees, printing fees and legal and accounting expenses, but excluding the underwriting discounts and commissions, will be approximately \$        .

We also have agreed to reimburse the underwriters for certain of their expenses, as set forth in the underwriting agreement, including an amount of up to \$        , that may be incurred in connection with the review by the Financial Industry Regulatory Authority, Inc. of the terms of the offering.

A prospectus in electronic format may be made available on the web sites maintained by one or more underwriters, or selling group members, if any, participating in the offering. The underwriters may agree to allocate a number of shares to underwriters and selling group members for sale to their online brokerage account holders. Internet distributions will be allocated by the representatives to underwriters and selling group members that may make Internet distributions on the same basis as other allocations.

We have agreed that we will not (i) offer, pledge, sell, contract to sell, sell any option or contract to purchase, purchase any option or contract to sell, grant any option, right or warrant to purchase or otherwise transfer or dispose of, directly or indirectly, or file with the Securities and Exchange Commission a registration statement under the Securities Act relating to, any shares of our Class A common stock or Class B common stock, or securities convertible into or exchangeable or exercisable for any shares of our Class A common stock or Class B common stock, or publicly disclose the intention to make any offer, sale, pledge, disposition or filing, or (ii) enter into any swap or other arrangement that transfers all or a portion of the economic consequences associated with the ownership of any shares of common stock or any such other securities (regardless of whether any of these transactions are to be settled by the delivery of shares of common stock or such other securities, in cash or otherwise), in each case without the prior written consent of J.P. Morgan Securities LLC and RBC Capital Markets, LLC for a period of 180 days after the date of this prospectus, other than the shares of our common stock to be sold hereunder and any shares of our common stock issued upon the exercise of options granted under our existing equity compensation plans.

Our directors and executive officers, the selling stockholders, and certain of our significant stockholders have entered into lock-up agreements with the underwriters prior to the commencement of this offering pursuant to which each of these persons or entities, with limited exceptions, for a period of 180 days after the date of this prospectus, may not, without the prior written consent of J.P. Morgan Securities LLC and RBC Capital Markets, LLC, (1) offer, pledge, sell, contract to sell, sell any option or contract to purchase, purchase any option or contract to sell, grant any option, right or warrant to purchase, or otherwise transfer or dispose of, directly or indirectly, any shares of our Class A common stock or Class B common stock, or any securities convertible into or exercisable or exchangeable for our Class A common stock or Class B common stock (including, without limitation, common stock or such other securities which may be deemed to be beneficially owned by such

## [Table of Contents](#)

directors, executive officers, managers and members in accordance with the rules and regulations of the SEC and securities which may be issued upon exercise of a stock option or warrant) or (2) enter into any swap or other agreement that transfers, in whole or in part, any of the economic consequences of ownership of the common stock or such other securities, whether any such transaction described in clause (1) or (2) above is to be settled by delivery of common stock or such other securities, in cash or otherwise, or (3) make any demand for or exercise any right with respect to the registration of any shares of our common stock or any security convertible into or exercisable or exchangeable for our common stock.

We and the selling stockholders have agreed to indemnify the underwriters against certain liabilities, including liabilities under the Securities Act of 1933, as amended.

We have applied to have our Class A common stock approved for listing on the Nasdaq Global Select Market under the symbol "ALTR".

In connection with this offering, the underwriters may engage in stabilizing transactions, which involves making bids for, purchasing and selling shares of Class A common stock in the open market for the purpose of preventing or retarding a decline in the market price of the Class A common stock while this offering is in progress. These stabilizing transactions may include making short sales of the Class A common stock, which involves the sale by the underwriters of a greater number of shares of Class A common stock than they are required to purchase in this offering, and purchasing shares of Class A common stock on the open market to cover positions created by short sales. Short sales may be "covered" shorts, which are short positions in an amount not greater than the underwriters' option to purchase additional shares referred to above, or may be "naked" shorts, which are short positions in excess of that amount. The underwriters may close out any covered short position either by exercising their option to purchase additional shares, in whole or in part, or by purchasing shares in the open market. In making this determination, the underwriters will consider, among other things, the price of shares available for purchase in the open market compared to the price at which the underwriters may purchase shares through the option to purchase additional shares. A naked short position is more likely to be created if the underwriters are concerned that there may be downward pressure on the price of the Class A common stock in the open market that could adversely affect investors who purchase in this offering. To the extent that the underwriters create a naked short position, they will purchase shares in the open market to cover the position.

The underwriters have advised us that, pursuant to Regulation M of the Securities Act of 1933, as amended, they may also engage in other activities that stabilize, maintain or otherwise affect the price of the Class A common stock, including the imposition of penalty bids. This means that if the representatives of the underwriters purchase Class A common stock in the open market in stabilizing transactions or to cover short sales, the representatives can require the underwriters that sold those shares as part of this offering to repay the underwriting discount received by them.

These activities may have the effect of raising or maintaining the market price of the Class A common stock or preventing or retarding a decline in the market price of the Class A common stock, and, as a result, the price of the Class A common stock may be higher than the price that otherwise might exist in the open market. If the underwriters commence these activities, they may discontinue them at any time. The underwriters may carry out these transactions on the Nasdaq Global Select Market, in the over-the-counter market or otherwise.

Prior to this offering, there has been no public market for our Class A common stock. The initial public offering price will be determined by negotiations between us, the selling stockholders and the representatives of the underwriters. In determining the initial public offering price, we, the selling stockholders and the representatives of the underwriters expect to consider a number of factors including:

- the information set forth in this prospectus and otherwise available to the representatives;

## [Table of Contents](#)

- our prospects and the history and prospects for the industry in which we compete;
- an assessment of our management;
- our prospects for future earnings;
- the general condition of the securities markets at the time of this offering;
- the recent market prices of, and demand for, publicly traded common stock of generally comparable companies; and
- other factors deemed relevant by the underwriters, the selling stockholders and us.

Neither we, the selling stockholders nor the underwriters can assure investors that an active trading market will develop for our Class A common shares, or that the shares will trade in the public market at or above the initial public offering price.

Certain of the underwriters and their affiliates have provided in the past to us and our affiliates and may provide from time to time in the future certain commercial banking, financial advisory, investment banking and other services for us and such affiliates in the ordinary course of their business, for which they have received and may continue to receive customary fees and commissions. Affiliates of J.P. Morgan Securities LLC and RBC Capital Markets, LLC are lenders under our revolving credit facilities, and will receive more than 5% of the net proceeds of this offering in connection with (i) the repayment of outstanding loans under our revolving facilities and (ii) receipt of a portion of origination fees and expenses related to our New Credit Facility. In addition, from time to time, certain of the underwriters and their affiliates may effect transactions for their own account or the account of customers, and hold on behalf of themselves or their customers, long or short positions in our debt or equity securities or loans, and may do so in the future. Such investments and securities activities may involve securities and/or instruments of ours or our affiliates. The underwriters and their affiliates may also make investment recommendations and/or publish or express independent research views in respect of such securities or financial instruments and may hold, or recommend to clients that they acquire, long and/or short positions in such securities and instruments.

## **Conflicts of interest**

The offering is being conducted in accordance with the applicable provisions of Rule 5121 of the FINRA Conduct Rules because certain of the underwriters will have a "conflict of interest" pursuant to Rule 5121(f)(5)(C)(i). Affiliates of J.P. Morgan Securities LLC and RBC Capital Markets, LLC will receive more than 5% of the net proceeds of this offering in connection with the repayment of outstanding loans under our revolving credit agreement. See the section entitled "Use of proceeds." As such, any underwriter that has a conflict of interest pursuant to Rule 5121 will not confirm sales to accounts in which it exercises discretionary authority without the prior written consent of the customer. In accordance with Rule 5121, Deutsche Bank Securities Inc. has assumed the responsibilities of acting as a "qualified independent underwriter." In its role as a qualified independent underwriter, Deutsche Bank Securities Inc. has participated in the preparation of the registration statement and the prospectus and has exercised the usual standards of due diligence with respect thereto. We and the selling stockholders have agreed to indemnify Deutsche Bank Securities Inc. against certain liabilities incurred in connection with acting as a qualified independent underwriter, including liabilities under the Securities Act.

## **Selling restrictions**

### ***General***

Other than in the United States, no action has been taken by us or the underwriters that would permit a public offering of the securities offered by this prospectus in any jurisdiction where action for that purpose is required.

## [Table of Contents](#)

The securities offered by this prospectus may not be offered or sold, directly or indirectly, nor may this prospectus or any other offering material or advertisements in connection with the offer and sale of any such securities be distributed or published in any jurisdiction, except under circumstances that will result in compliance with the applicable rules and regulations of that jurisdiction. Persons into whose possession this prospectus comes are advised to inform themselves about and to observe any restrictions relating to the offering and the distribution of this prospectus. This prospectus does not constitute an offer to sell or a solicitation of an offer to buy any securities offered by this prospectus in any jurisdiction in which such an offer or a solicitation is unlawful.

### **Canada**

The shares may be sold only to purchasers purchasing, or deemed to be purchasing, as principal that are accredited investors, as defined in National Instrument 45-106 Prospectus Exemptions or subsection 73.3(1) of the Securities Act (Ontario), and are permitted clients, as defined in National Instrument 31-103 Registration Requirements, Exemptions and Ongoing Registrant Obligations. Any resale of the shares must be made in accordance with an exemption from, or in a transaction not subject to, the prospectus requirements of applicable securities laws.

Securities legislation in certain provinces or territories of Canada may provide a purchaser with remedies for rescission or damages if this prospectus (including any amendment thereto) contains a misrepresentation, provided that the remedies for rescission or damages are exercised by the purchaser within the time limit prescribed by the securities legislation of the purchaser's province or territory. The purchaser should refer to any applicable provisions of the securities legislation of the purchaser's province or territory for particulars of these rights or consult with a legal advisor. Pursuant to section 3A.3 of National Instrument 33-105 Underwriting Conflicts (NI 33-105), the underwriters are not required to comply with the disclosure requirements of NI 33-105 regarding underwriter conflicts of interest in connection with this offering.

### **European economic area**

In relation to each Member State of the European Economic Area (each, a "Relevant Member State"), no offer of shares may be made to the public in that Relevant Member State other than:

- A. to any legal entity which is a qualified investor as defined in the Prospectus Directive;
- B. to fewer than 100 or, if the Relevant Member State has implemented the relevant provision of the 2010 PD Amending Directive, 150, natural or legal persons (other than qualified investors as defined in the Prospectus Directive), as permitted under the Prospectus Directive, subject to obtaining the prior consent of the representatives; or
- C. in any other circumstances falling within Article 3(2) of the Prospectus Directive,

provided that no such offer of shares shall require the Company, the selling stockholders or the representatives to publish a prospectus pursuant to Article 3 of the Prospectus Directive or supplement a prospectus pursuant to Article 16 of the Prospectus Directive.

Each person in a Relevant Member State who initially acquires any shares or to whom any offer is made will be deemed to have represented, acknowledged and agreed that it is a "qualified investor" within the meaning of the law in that Relevant Member State implementing Article 2(1)(e) of the Prospectus Directive. In the case of any shares being offered to a financial intermediary as that term is used in Article 3(2) of the Prospectus Directive, each such financial intermediary will be deemed to have represented, acknowledged and agreed that the shares acquired by it in the offer have not been acquired on a non-discretionary basis on behalf of, nor have

## [Table of Contents](#)

they been acquired with a view to their offer or resale to, persons in circumstances which may give rise to an offer of any shares to the public other than their offer or resale in a Relevant Member State to qualified investors as so defined or in circumstances in which the prior consent of the representatives has been obtained to each such proposed offer or resale.

The Company, the selling stockholders, the representatives and their affiliates will rely upon the truth and accuracy of the foregoing representations, acknowledgements and agreements.

This prospectus has been prepared on the basis that any offer of shares in any Relevant Member State will be made pursuant to an exemption under the Prospectus Directive from the requirement to publish a prospectus for offers of shares. Accordingly any person making or intending to make an offer in that Relevant Member State of shares which are the subject of the offering contemplated in this prospectus may only do so in circumstances in which no obligation arises for the Company or any of the underwriters to publish a prospectus pursuant to Article 3 of the Prospectus Directive in relation to such offer. Neither the Company, the selling stockholders, nor the underwriters have authorized, nor do they authorize, the making of any offer of shares in circumstances in which an obligation arises for the Company, the selling stockholders or the underwriters to publish a prospectus for such offer.

For the purpose of the above provisions, the expression “an offer to the public” in relation to any shares in any Relevant Member State means the communication in any form and by any means of sufficient information on the terms of the offer and the shares to be offered so as to enable an investor to decide to purchase or subscribe the shares, as the same may be varied in the Relevant Member State by any measure implementing the Prospectus Directive in the Relevant Member State and the expression “Prospectus Directive” means Directive 2003/71/EC (including the 2010 PD Amending Directive, to the extent implemented in the Relevant Member States) and includes any relevant implementing measure in the Relevant Member State and the expression “2010 PD Amending Directive” means Directive 2010/73/EU.

### ***United Kingdom***

In addition, in the United Kingdom, this document is being distributed only to, and is directed only at, and any offer subsequently made may only be directed at persons who are “qualified investors” (as defined in the Prospectus Directive) (i) who have professional experience in matters relating to investments falling within Article 19 (5) of the Financial Services and Markets Act 2000 (Financial Promotion) Order 2005, as amended, or “the Order”, and/or (ii) who are high net worth companies (or persons to whom it may otherwise be lawfully communicated) falling within Article 49(2)(a) to (d) of the Order (all such persons together being referred to as “relevant persons”).

Any person in the United Kingdom that is not a relevant person should not act or rely on the information included in this document or use it as basis for taking any action. In the United Kingdom, any investment or investment activity that this document relates to may be made or taken exclusively by relevant persons. Any person in the United Kingdom that is not a relevant person should not act or rely on this document or any of its contents.

### ***Hong Kong***

The shares have not been offered or sold and will not be offered or sold in Hong Kong, by means of any document, other than (a) to “professional investors” as defined in the Securities and Futures Ordinance (Cap. 571) of Hong Kong and any rules made under that Ordinance; or (b) in other circumstances which do not result in the document being a “prospectus” as defined in the Companies Ordinance (Cap. 32) of Hong Kong or which do not constitute an offer to the public within the meaning of that Ordinance. No advertisement, invitation or document relating to the shares has been or may be issued or has been or may be in the

## [Table of Contents](#)

possession of any person for the purposes of issue, whether in Hong Kong or elsewhere, which is directed at, or the contents of which are likely to be accessed or read by, the public of Hong Kong (except if permitted to do so under the securities laws of Hong Kong) other than with respect to shares which are or are intended to be disposed of only to persons outside Hong Kong or only to “professional investors” as defined in the Securities and Futures Ordinance and any rules made under that Ordinance.

### **Japan**

The shares have not been and will not be registered under the Financial Instruments and Exchange Act. Accordingly, the shares may not be offered or sold, directly or indirectly, in Japan or to, or for the benefit of, any resident of Japan (which term as used herein means any person resident in Japan, including any corporation or other entity organized under the laws of Japan), or to others for re-offering or resale, directly or indirectly, in Japan or to or for the benefit of a resident of Japan, except pursuant to an exemption from the registration requirements, and otherwise in compliance with, the Financial Instruments and Exchange Act and any other applicable laws, regulations and ministerial guidelines of Japan.

### **Singapore**

This prospectus has not been registered as a prospectus with the Monetary Authority of Singapore. Accordingly, this prospectus and any other document or material in connection with the offer or sale, or invitation for subscription or purchase, of shares may not be circulated or distributed, nor may the shares be offered or sold, or be made the subject of an invitation for subscription or purchase, whether directly or indirectly, to persons in Singapore other than (i) to an institutional investor under Section 274 of the Securities and Futures Act, Chapter 289 of Singapore, or “the SFA”, (ii) to a relevant person pursuant to Section 275(1), or any person pursuant to Section 275(1A), and in accordance with the conditions specified in Section 275, of the SFA, or (iii) otherwise pursuant to, and in accordance with the conditions of, any other applicable provision of the SFA.

Where the shares are subscribed or purchased under Section 275 of the SFA by a relevant person which is:

- (a) a corporation (which is not an accredited investor (as defined in Section 4A of the SFA)) the sole business of which is to hold investments and the entire share capital of which is owned by one or more individuals, each of whom is an accredited investor; or
- (b) a trust (where the trustee is not an accredited investor) whose sole purpose is to hold investments and each beneficiary of the trust is an individual who is an accredited investor, securities (as defined in Section 239(1) of the SFA) of that corporation or the beneficiaries’ rights and interest (howsoever described) in that trust shall not be transferred within six months after that corporation or that trust has acquired the securities pursuant to an offer made under Section 275 of the SFA except:
  - (a) to an institutional investor or to a relevant person defined in Section 275(2) of the SFA, or to any person arising from an offer referred to in Section 275(1A) or Section 276(4)(i)(B) of the SFA;
  - (b) where no consideration is or will be given for the transfer;
  - (c) where the transfer is by operation of law;
  - (d) as specified in Section 276(7) of the SFA; or
  - (e) as specified in Regulation 32 of the Securities and Futures (Offers of Investments) (Shares and Debentures) Regulations 2005 of Singapore.



## Legal matters

The validity of the shares of Class A common stock offered hereby will be passed upon for us by Lowenstein Sandler LLP, New York City, New York. Goodwin Procter LLP, Boston, Massachusetts is representing the underwriters in this offering.

## Experts

Ernst & Young LLP, independent registered public accounting firm, has audited our consolidated financial statements at December 31, 2015 and 2016, and for each of the two years in the period ended December 31, 2016, as set forth in their report. We have included our financial statements in the prospectus and elsewhere in the registration statement in reliance on Ernst & Young LLP's report, given on their authority as experts in accounting and auditing.

## Where you can find more information

We filed a registration statement on Form S-1 with the SEC with respect to the registration of the Class A common stock offered for sale with this prospectus. This prospectus, which constitutes a part of the registration statement, does not contain all of the information set forth in the registration statement and the exhibits to the registration statement. For further information about us, the Class A common stock we are offering by this prospectus and related matters, you should review the registration statement, including the exhibits filed as a part of the registration statement. Statements contained in this prospectus about the contents of any contract or any other document that is filed as an exhibit to the registration statement are not necessarily complete, and we refer you to the full text of the contract or other document filed as an exhibit to the registration statement. A copy of the registration statement and the exhibits that were filed with the registration statement may be inspected without charge at the public reference facilities maintained by the SEC at 100 F. Street, N.E., Washington, D.C. 20549, and copies of all or any part of the registration statement may be obtained from the SEC upon payment of the prescribed fee. Information on the operation of the public reference facilities may be obtained by calling the SEC at 1-800-SEC-0330. The SEC maintains a website that contains reports, proxy and information statements, and other information regarding registrants that file electronically with the SEC. The address of the site is <http://www.sec.gov>.

Upon completion of this offering, we will become subject to the information and periodic reporting requirements of the Securities Exchange Act of 1934, as amended, and, in accordance with such requirements, will file periodic reports, proxy statements, and other information with the SEC. These periodic reports, proxy statements, and other information will be available for inspection and copying at the regional offices, public reference facilities, and web site of the SEC referred to above. We intend to furnish our stockholders with annual reports containing consolidated financial statements audited by our independent registered accounting firm.

# Altair Engineering Inc. and subsidiaries

## Index to consolidated financial statements

	Page
<a href="#">Report of independent registered public accounting firm</a>	F-2
Consolidated financial statements	
<a href="#">Consolidated balance sheets</a>	F-3
<a href="#">Consolidated statements of operations</a>	F-4
<a href="#">Consolidated statements of comprehensive income (loss)</a>	F-5
<a href="#">Consolidated statement of changes in stockholders' deficit</a>	F-6
<a href="#">Consolidated statements of cash flows</a>	F-7
<a href="#">Notes to consolidated financial statements</a>	F-8

## Report of Independent Registered Public Accounting Firm

Board of Directors and Stockholders of  
Altair Engineering Inc.

We have audited the accompanying consolidated balance sheets of Altair Engineering Inc. and subsidiaries as of December 31, 2015 and 2016, and the related consolidated statements of operations, comprehensive income (loss), changes in stockholders' deficit and cash flows for the years then ended. These financial statements are the responsibility of the Company's management. Our responsibility is to express an opinion on these financial statements based on our audits.

We conducted our audits in accordance with the standards of the Public Company Accounting Oversight Board (United States). Those standards require that we plan and perform the audit to obtain reasonable assurance about whether the financial statements are free of material misstatement. We were not engaged to perform an audit of the Company's internal control over financial reporting. Our audits included consideration of internal control over financial reporting as a basis for designing audit procedures that are appropriate in the circumstances, but not for the purpose of expressing an opinion on the effectiveness of the Company's internal control over financial reporting. Accordingly, we express no such opinion. An audit also includes examining, on a test basis, evidence supporting the amounts and disclosures in the consolidated financial statements, assessing the accounting principles used and significant estimates made by management, and evaluating the overall financial statement presentation. We believe that our audits provide a reasonable basis for our opinion.

In our opinion, the financial statements referred to above present fairly, in all material respects, the consolidated financial position of Altair Engineering Inc. and subsidiaries at December 31, 2015 and 2016, and the consolidated results of their operations and their cash flows for the years then ended in conformity with U.S. generally accepted accounting principles.

/s/ Ernst & Young LLP

Detroit, Michigan

June 16, 2017, except as to the third paragraph of Note 2,  
as to which the date is October 6, 2017

# Altair Engineering Inc. and subsidiaries

## Consolidated balance sheets

(in thousands)	December 31,		June 30,	Pro forma Liabilities, Mezzanine Equity and Stockholders' Deficit as of June 30, 2017 (unaudited)
	2015	2016	2017	
<b>ASSETS</b>				
CURRENT ASSETS:				
Cash and cash equivalents	\$ 13,756	\$ 16,874	\$ 17,419	
Accounts receivable—net	66,821	70,498	61,499	
Inventory	2,075	1,227	1,689	
Income tax receivable	6,075	9,069	11,979	
Prepaid expenses and other current assets	7,096	7,435	10,012	
Total current assets	95,823	105,103	102,598	
Property and equipment—net	25,379	29,708	29,449	
Goodwill	29,240	36,625	43,666	
Other intangible assets—net	9,390	11,168	16,012	
Deferred tax assets	57,199	62,896	66,049	
Other long-term assets	4,819	5,276	7,836	
<b>TOTAL ASSETS</b>	<b>\$221,850</b>	<b>\$250,776</b>	<b>\$265,610</b>	
<b>LIABILITIES AND STOCKHOLDERS' DEFICIT</b>				
CURRENT LIABILITIES:				
Current portion of long-term debt	\$ 13,817	\$ 10,435	\$ 10,601	\$ 10,601
Accounts payable	6,216	5,009	6,413	6,413
Accrued compensation and benefits	20,327	22,955	22,294	22,294
Other accrued expenses and current liabilities	17,052	18,945	18,783	18,783
Deferred revenue	93,508	100,661	123,820	123,820
Total current liabilities	150,920	158,005	181,911	181,911
Long-term debt, net of current portion	69,360	74,806	60,494	60,494
Deferred revenue—non-current	13,008	13,268	12,960	12,960
Stock-based compensation awards	17,725	22,236	35,948	19,097
Other long-term liabilities	12,876	17,114	13,386	13,386
<b>TOTAL LIABILITIES</b>	<b>263,889</b>	<b>285,429</b>	<b>304,699</b>	<b>287,848</b>
Commitments and contingencies				
MEZZANINE EQUITY	\$ —	\$ —	\$ 2,345	\$ 2,345
STOCKHOLDERS' DEFICIT:				
Preferred and common stock (\$0.0001 par value)				
Preferred stock, no shares authorized, issued or outstanding as of December 31, 2015 and 2016 and June 30, 2017; authorized 45,000 shares, no shares issued or outstanding as of June 30, 2017, pro forma	—	—	—	—
Old Class A common stock, authorized 99,280 shares; issued and outstanding, 41,680 and 41,204 as of December 31, 2015 and 2016, respectively	4	4	—	—
Old Class B common stock, authorized 25,152 shares; issued and outstanding, 5,748 and 8,900 as of December 31, 2015 and 2016, respectively	1	1	—	—
New Class A common stock, authorized 76,000 shares, issued and outstanding 9,388 as of June 30, 2017, actual; authorized 513,797 shares, 9,388 issued and outstanding as of June 30, 2017 pro forma	—	—	1	1
New Class B common stock, authorized 44,000 shares, issued and outstanding 41,204 as of June 30, 2017, actual; authorized 41,204 shares, 41,204 issued and outstanding as of June 30, 2017 pro forma	—	—	4	4
Additional paid-in capital	41,909	39,688	40,884	40,884
Accumulated deficit	(77,255)	(67,092)	(76,526)	(59,675)
Accumulated other comprehensive loss	(6,708)	(7,264)	(5,797)	(5,797)
Total Altair Engineering Inc. stockholders' deficit	(42,049)	(34,663)	(41,434)	(24,583)
Noncontrolling interest	10	10	—	—
<b>TOTAL STOCKHOLDERS' DEFICIT</b>	<b>(42,039)</b>	<b>(34,653)</b>	<b>(41,434)</b>	<b>(24,583)</b>
<b>TOTAL LIABILITIES, MEZZANINE EQUITY AND STOCKHOLDERS' DEFICIT</b>	<b>\$221,850</b>	<b>\$250,776</b>	<b>\$265,610</b>	<b>\$ 265,610</b>

See accompanying notes to consolidated financial statements.

# Altair Engineering Inc. and subsidiaries

## Consolidated statements of operations

(in thousands, except share data)	Years ended December 31,		Six months ended June 30,	
	2015	2016	2016	2017
				(unaudited)
Revenue:				
Software	\$205,567	\$223,818	\$106,929	\$113,697
Software related services	37,294	35,770	17,790	17,175
Total software	242,861	259,588	124,719	130,872
Client engineering services	45,075	47,702	24,289	24,594
Other	6,193	5,950	3,332	3,062
Total revenue	294,129	313,240	152,340	158,528
Cost of revenue:				
Software	27,406	31,962	15,021	17,633
Software related services	30,079	27,653	13,838	13,773
Total software	57,485	59,615	28,859	31,406
Client engineering services	36,081	38,106	19,207	19,969
Other	5,642	4,879	2,692	2,297
Total cost of revenue	99,208	102,600	50,758	53,672
Gross profit	194,921	210,640	101,582	104,856
Operating expenses:				
Research and development	62,777	71,325	34,012	41,608
Sales and marketing	63,080	66,086	32,093	36,338
General and administrative	54,069	57,202	27,882	37,290
Amortization of intangible assets	2,624	3,322	1,477	2,098
Other operating income	(2,576)	(2,742)	(1,129)	(3,330)
Total operating expenses	179,974	195,193	94,335	114,004
Operating income (loss)	14,947	15,447	7,247	(9,148)
Interest expense	2,416	2,265	1,247	1,159
Other expense (income), net	782	(520)	(652)	786
Income (loss) before income taxes	11,749	13,702	6,652	(11,093)
Income tax expense (benefit)	818	3,539	2,699	(1,659)
Net income (loss)	\$ 10,931	\$ 10,163	\$ 3,953	\$ (9,434)
Income (loss) per share:				
Net income (loss) per share attributable to common stockholders, basic	\$ 0.23	\$ 0.21	\$ 0.08	\$ (0.19)
Net income (loss) per share attributable to common stockholders, diluted	\$ 0.19	\$ 0.18	\$ 0.07	\$ (0.19)
Weighted average shares outstanding:				
Weighted average number of shares used in computing net income (loss) per share, basic	46,609	48,852	47,891	50,255
Weighted average number of shares used in computing net income (loss) per share, diluted	58,709	57,856	57,236	50,255
Pro forma net income (loss) (unaudited)		\$ 12,341		\$ (3,303)
Pro forma net income (loss) per share:				
Pro forma net income (loss) per share attributable to common stockholders, basic (unaudited)		\$ 0.25		\$ (0.07)
Pro forma net income (loss) per share attributable to common stockholders, diluted (unaudited)		\$ 0.21		\$ (0.07)

See accompanying notes to consolidated financial statements.

## Altair Engineering Inc. and subsidiaries

### Consolidated statements of comprehensive income (loss)

(in thousands)	Years ended December 31,		Six months ended June 30,	
	2015	2016	2016	2017
Net income (loss)	\$ 10,931	\$ 10,163	\$ 3,953	(9,434)
Other comprehensive income (loss), net of tax:				(unaudited)
Foreign currency translation (net of tax effect of \$953, \$(60), \$(81) and \$0, respectively)	(2,115)	20	(1,080)	1,511
Retirement related benefit plans (net of tax effect of \$(36), \$195, \$102 and \$0, respectively)	(253)	(576)	14	(44)
Total other comprehensive (loss) income	(2,368)	(556)	(1,066)	1,467
Comprehensive income (loss)	8,563	9,607	2,887	(7,967)
Less: comprehensive loss attributable to noncontrolling interest	(1)	—	—	—
Comprehensive income (loss) attributable to Altair Engineering Inc.	\$ 8,564	\$ 9,607	\$ 2,887	\$ (7,967)

See accompanying notes to consolidated financial statements.

# Altair Engineering Inc. and subsidiaries

## Consolidated statement of changes in stockholders' deficit

(in thousands, except share data)	Common stock <sup>(1)</sup>				Additional paid-in capital	Accumulated deficit	Accumulated other comprehensive loss	Total Altair Engineering Inc. stockholders' deficit	Non-controlling interest	Total stockholders' deficit
	New class A voting		New class B voting							
	Shares	Amount	Shares	Amount						
Balance at January 1, 2015	4,284	\$ 1	41,564	\$ 4	\$ 41,525	\$ (87,461)	\$ (4,341)	\$ (50,272)	\$ 11	\$ (50,261)
Net income	—	—	—	—	—	10,931	—	10,931	—	10,931
Issuance of common stock	1,728	—	200	—	1,036	—	—	1,036	—	1,036
Stock redemptions	(264)	—	(84)	—	(1,221)	—	—	(1,221)	—	(1,221)
Return of capital	—	—	—	—	—	(725)	—	(725)	—	(725)
Stock-based compensation	—	—	—	—	569	—	—	569	—	569
Foreign currency translation, net of tax	—	—	—	—	—	—	(2,114)	(2,114)	(1)	(2,115)
Retirement related benefit plans, net of tax	—	—	—	—	—	—	(253)	(253)	—	(253)
Balance at December 31, 2015	5,748	1	41,680	4	41,909	(77,255)	(6,708)	(42,049)	10	(42,039)
Net income	—	—	—	—	—	10,163	—	10,163	—	10,163
Issuance of common stock	3,484	—	—	—	456	—	—	456	—	456
Stock redemptions	(332)	—	(476)	—	(3,291)	—	—	(3,291)	—	(3,291)
Stock-based compensation	—	—	—	—	614	—	—	614	—	614
Foreign currency translation, net of tax	—	—	—	—	—	—	20	20	—	20
Retirement related benefit plans, net of tax	—	—	—	—	—	—	(576)	(576)	—	(576)
Balance at December 31, 2016	8,900	1	41,204	4	39,688	(67,092)	(7,264)	(34,663)	10	(34,653)
Net loss (unaudited)	—	—	—	—	—	(9,434)	—	(9,434)	—	(9,434)
Issuance of common stock (unaudited)	488	—	—	—	890	—	—	890	—	890
Purchase of noncontrolling interests (unaudited)	—	—	—	—	(19)	—	—	(19)	(10)	(29)
Stock-based compensation (unaudited)	—	—	—	—	325	—	—	325	—	325
Foreign currency translation, net of tax (unaudited)	—	—	—	—	—	—	1,511	1,511	—	1,511
Retirement related benefit plans, net of tax (unaudited)	—	—	—	—	—	—	(44)	(44)	—	(44)
Balance at June 30, 2017 (unaudited)	9,388	\$ 1	41,204	\$ 4	\$ 40,884	\$ (76,526)	\$ (5,797)	\$ (41,434)	\$ —	\$ (41,434)

<sup>(1)</sup> All references to Common stock refer to the Company's currently existing Class A and Class B shares following the *Recapitalization* as described in Note 10.

See accompanying notes to consolidated financial statements.

# Altair Engineering Inc. and subsidiaries

## Consolidated statements of cash flows

(in thousands)	Years Ended December 31,		Six months ended June 30,	
	2015	2016	2016	2017
				(unaudited)
<b>OPERATING ACTIVITIES:</b>				
Net income (loss)	\$ 10,931	\$ 10,163	\$ 3,953	\$ (9,434)
Adjustments to reconcile net income (loss) to net cash provided by operating activities:				
Depreciation and amortization	8,378	9,980	4,847	5,084
Provision for bad debt	145	291	133	116
Write-down of inventory to net realizable value	1,003	179	—	—
Stock-based compensation expense	597	5,132	175	14,037
Deferred income taxes	(9,131)	(6,076)	194	(3,679)
Other, net	124	86	(8)	34
Changes in assets and liabilities:				
Accounts receivable	(8,120)	(4,397)	11,019	11,412
Prepaid expenses and other current assets	(5,115)	(2,337)	(2,869)	(3,850)
Other long-term assets	(1,526)	(930)	(732)	(2,567)
Accounts payable	558	(1,321)	(945)	955
Accrued compensation and benefits	2,006	2,366	(1,202)	(1,531)
Other accrued expenses and current liabilities	2,488	(1,173)	(3,120)	(2,331)
Deferred revenue	8,500	9,422	10,561	17,871
Net cash provided by operating activities	10,838	21,385	22,006	26,117
<b>INVESTING ACTIVITIES:</b>				
Capital expenditures	(5,233)	(9,444)	(3,699)	(4,335)
Payments for acquisition of businesses	(2,757)	(6,499)	(4,775)	(6,437)
Purchase of noncontrolling interests	—	—	—	(29)
Other investing activities, net	(40)	(90)	(63)	(119)
Net cash used in investing activities	(8,030)	(16,033)	(8,537)	(10,920)
<b>FINANCING ACTIVITIES:</b>				
Borrowings under revolving commitment	103,186	151,928	79,183	44,227
Payments on revolving commitment	(91,673)	(136,087)	(75,279)	(53,564)
Principal payments on long-term debt	(15,950)	(16,232)	(10,939)	(5,248)
Proceeds from issuance of debt	1,248	2,030	2,028	—
Payments of deferred offering costs	—	—	—	(869)
Principal payments on capital leases	(55)	(185)	(8)	(20)
Payment for return of capital	—	(725)	(725)	—
Proceeds from issuance of common stock	291	456	202	476
Payments for redemption of common stock	(1,744)	(3,049)	(1,137)	(611)
Net cash used in financing activities	(4,697)	(1,864)	(6,675)	(15,609)
Effect of exchange rate changes on cash, cash equivalents and restricted cash	(1,639)	(362)	646	962
Net (decrease) increase in cash, cash equivalents and restricted cash	(3,528)	3,126	7,440	550
Cash, cash equivalents and restricted cash at beginning of year	17,541	14,013	14,013	17,139
Cash, cash equivalents and restricted cash at end of period	\$ 14,013	\$ 17,139	\$ 21,453	\$ 17,689
<b>Supplemental disclosures of cash flow:</b>				
Interest paid	\$ 2,261	\$ 2,190	\$ 1,083	\$ 1,163
Income taxes paid	\$ 5,626	\$ 5,909	\$ 2,178	\$ 2,352
<b>Supplemental disclosure of non-cash investing and financing activities:</b>				
Notes issued for stock redemptions	\$ 753	\$ 807	\$ 1,160	\$ —
Capital leases	\$ 270	\$ 129	\$ —	\$ —
Promissory notes issued for acquisitions	\$ 750	\$ 4,182	\$ 2,407	\$ 2,728
Issuance of common stock in connection with acquisitions	\$ 745	\$ —	\$ —	\$ 415
Obligations for return of capital in other current liabilities	\$ 725	\$ —	\$ —	\$ —
Deferred offering costs in other long-term assets	\$ —	\$ —	\$ —	\$ 1,522
Property and equipment in accounts payable, other accrued expenses and current liabilities and other liabilities	\$ 178	\$ 1,777	\$ 2,035	\$ 155
Issuance of common stock with put rights	\$ —	\$ —	\$ —	\$ 2,345

See accompanying notes to consolidated financial statements.



# Altair Engineering Inc. and subsidiaries

## Notes to consolidated financial statements

(Unaudited as of June 30, 2017 and for the six months ended June 30, 2016 and 2017)

### 1. Description of business

Altair Engineering Inc. (“Altair” or the “Company”) was formed in 1985 and incorporated in the state of Michigan. The Company, together with its subsidiaries, is a provider of enterprise-class engineering software to enable innovation across the entire product lifecycle from concept design to in-service operation.

The Company’s simulation-driven approach to innovation is powered by its broad portfolio of high-fidelity and high-performance physics solvers. The Company’s integrated suite of software optimizes design performance across multiple disciplines including structures, motion, fluids, thermal management, electromagnetics, system modeling and embedded systems, while also providing data analytics and true-to-life visualization and rendering.

Altair’s engineering and design platform offers a wide range of multi-disciplinary computer aided engineering (“CAE”) solutions. The Company engages with its customers to provide consulting, training, and support, especially when applying optimization.

Altair also provides Client Engineering Services to support its customers with long-term ongoing product design and development expertise. This has the benefit of embedding the Company within customers, deepening its understanding of their processes, and allowing the Company to more quickly perceive trends in the overall market, helping the Company to better tailor its research and development and sales initiatives. The Company hires simulation specialists, industrial designers, design engineers, materials experts, development and test specialists, manufacturing engineers and information technology specialists for placement at a customer site for specific customer-directed assignments.

### 2. Summary of significant accounting policies

#### *Principles of consolidation*

The accompanying consolidated financial statements have been prepared using accounting principles generally accepted in the United States of America (“U.S. GAAP”). The consolidated financial statements include the results of the Company and its controlled subsidiaries. Third-party holdings of equity interests in the Company’s subsidiaries that are less than controlled represent noncontrolling interests. Intercompany accounts and transactions have been eliminated in the consolidated financial statements.

#### *Use of estimates*

The preparation of the consolidated financial statements in conformity with U.S. GAAP requires management to make estimates and assumptions that affect the reported amounts of assets and liabilities, and disclosures of contingent assets and liabilities at the date of the financial statements, and reported amounts of revenue and expenses during the reporting periods. On an ongoing basis, management evaluates its significant estimates including provision for doubtful accounts, tax valuation allowances, liabilities for uncertain tax provisions, impairment of goodwill and intangible assets, retirement obligations, useful lives of intangible assets, revenue for fixed price contracts, valuation of common stock, and stock-based compensation. Actual results could differ from those estimates.

***Delaware Conversion***

On October 5, 2017, the Company became a Delaware corporation and effected a four-for-one stock split of its common stock. On the effective date of the Company becoming a Delaware corporation, (i) each share of outstanding common stock was increased to four shares of common stock, par value \$0.0001 per share, (ii) the number of shares of common stock issuable under each outstanding option to purchase common stock was increased on a four-for-one basis, (iii) the exercise price of each outstanding option to purchase common stock was reduced on a four-for-one basis; and (iv) the redemption price of each outstanding put option was reduced on a four-for-one basis. All share and per share information referenced throughout the consolidated financial statements and unaudited interim consolidated financial statements have been retroactively adjusted to reflect this stock split.

***Unaudited interim consolidated financial information***

The accompanying interim consolidated balance sheet as of June 30, 2017, the interim consolidated statements of operations, comprehensive income (loss), stockholders' deficit, and the cash flows for the six months ended June 30, 2016 and 2017 are unaudited. The unaudited interim financial statements have been prepared on the same basis as the audited consolidated financial statements, and in management's opinion, include all adjustments, consisting of only normal recurring adjustments, necessary for the fair presentation of the Company's financial position as of June 30, 2017, and its results of operations and cash flows for the six months ended June 30, 2016 and 2017. The financial data and the other financial information disclosed in the notes to these consolidated financial statements related to the six-month periods are also unaudited. The results of operations for the six months ended June 30, 2017 are not necessarily indicative of the results to be expected for the full year or any other period.

***Unaudited pro forma balance sheet information***

The unaudited pro forma balance sheet information as of June 30, 2017 presents the Company's liabilities, mezzanine equity and stockholders' deficit to give effect to the assumed automatic conversion of the class A redeemable common shares into shares of Class A common stock that will occur upon effectiveness of the initial public offering, as though the conversion had occurred as of the beginning of the period.

***Foreign currency translation***

The functional currency of the Company's foreign subsidiaries is their respective local currency. The assets and liabilities of the subsidiaries are translated to U.S. dollars at the exchange rate on the balance sheet date. Equity balances and transactions are translated using historical exchange rates. Revenues and expenses are translated at the average exchange rate during the period. Translation adjustments arising from the use of differing exchange rates from period to period are recorded as a component of accumulated other comprehensive loss within stockholders' deficit.

All assets and liabilities denominated in a currency other than the functional currency are remeasured into the functional currency with gains and losses recognized in foreign currency losses, net, in the consolidated statements of operations. The Company has no transactions which hedge purchase commitments and no intercompany balances which are designated as being of a long-term investment in nature.

***Revenue recognition***

The Company generates revenue from the following sources: (1) Software; (2) Client engineering services; and (3) Other. Revenue is recognized when persuasive evidence of an agreement exists, delivery has occurred or

## [Table of Contents](#)

services have been rendered, the fee is fixed or determinable, and collection of the fee is probable or reasonably assured. Certain transactions require that government imposed taxes be assessed to the customer. The Company presents revenue net of such government imposed taxes.

### *Software revenue*

#### *Software component*

Software revenue includes product revenue from software product licensing arrangements, related services consisting of software maintenance and support in the form of post-contract customer support ("PCS"), and professional services such as consulting and training services. Software products are sold to customers primarily under a term-based software licensing model and to a lesser degree, perpetual software licenses. Software revenue also includes consulting services from product design and development projects.

Most term-based software license agreements include the Company's patented units-based subscription model which allows customers to license a pool of units for their organizations, providing individual users flexible access to the Company's entire portfolio of software applications as well as to its growing portfolio of partner products. The amount of software usage is limited by the number of the units licensed by the customer. Revenue from these arrangements is fixed (based on the units licensed) and is not based on actual customer usage of each software product.

Software product license arrangements may include PCS and professional services, such as consulting and training services, which represent multiple-element arrangements. The Company has analyzed the elements included in its multiple element arrangements and has determined that it does not have vendor-specific objective evidence ("VSOE") of fair value to allocate revenue to its software products license, PCS, and professional services including consulting and training. For arrangements that have two or more elements such as software, PCS or professional services for which the Company has not established VSOE of fair value, the Company uses the combined services approach to recognize revenue for these transactions. Under the combined services approach, revenue from the software product licenses, including perpetual licenses, PCS and professional services, if applicable, are considered to be one accounting unit and, once the software has been delivered and the provision of each undelivered service has commenced, are recognized ratably over the remaining period of the arrangement which consists of the longer of the PCS period, or the period the professional services are expected to be performed. If the professional services are essential to the functionality of the software products, then revenue recognition does not commence until such services are completed. In transactions with resellers, the Company contracts only with the reseller, in which pricing, length of licenses and support services are agreed upon. The reseller negotiates the price charged and length of licenses and support service directly with its customer.

The term-based software license arrangements typically have a duration of 12 months and include PCS, including the right to receive unspecified software upgrades, when and if available during the license term. The Company does not charge separately for PCS. Revenues for software licenses sold on a term-based model are recognized ratably over the term of the license arrangement, once all other revenue recognition criteria have been met.

The Company also sells perpetual licenses to its customers. The Company does not have VSOE of fair value for PCS, which is sold along with the perpetual licenses. As a result, revenue from these arrangements is recognized ratably over the initial PCS term.

## [Table of Contents](#)

### *Software related services component*

Consulting services from product design and development projects are provided to customers on a time-and-materials ("T&M") or fixed-price basis. Altair recognizes software services revenue for T&M contracts based upon hours worked and contractually agreed-upon hourly rates. Revenue from fixed-price engagements is recognized using the proportional performance method based on the ratio of costs incurred, to the total estimated project costs. Project costs are based on standard rates, which vary by the consultant's professional level, plus all direct expenses incurred to complete the engagement that are not reimbursed by the client. Project costs are typically expensed as incurred. The use of the proportional performance method is dependent upon management's ability to reliably estimate the costs to complete a project. We use historical experience as a basis for future estimates to complete current projects. Additionally, the Company believes that costs are the best available measure of performance. If the costs to complete a project are not estimable or the completion is uncertain, the revenue is recognized upon completion of the services.

### *Client engineering services revenue*

Client engineering services revenue are derived from professional services for staffing primarily representing engineers located at a customer site. These professional services are provided to customers on a T&M basis. The Company recognizes engineering services revenue for T&M contracts based upon hours worked and contractually agreed-upon hourly rates.

### *Other revenue*

Other revenue includes product revenue from the sale of LED products for the replacement of fluorescent tubes. Revenue from the sale of LED products for the replacement of fluorescent tubes is recognized when all revenue recognition criteria stated above are met, which is generally when the products are delivered to resellers or to end customers. Sales returns, which reduce revenue and cost of revenue, are estimated using historical experience.

## **Cost of revenue**

### *Cost of software*

Cost of software revenue consist of expenses related to software licensing and customer support. Significant expenses include employee related costs for support team members, travel costs, and royalties for third-party software products available to customers through the Company's products or as part of the Company's Partner Alliance Program.

### *Cost of client engineering services*

Cost of engineering services revenue consist primarily of employee compensation costs.

### *Cost of other*

Cost of other revenue includes the cost of LED lighting products and freight related to products sold to retail and commercial sales channels.

## **Deferred revenue**

Deferred revenue consists of customer billings or payments received in advance of the recognition of revenue and is recognized as revenue when revenue recognition criteria are met.

**Deferred offering costs**

Deferred offering costs, which consist of direct incremental legal and accounting fees, and other direct costs relating to the Company's initial public offering ("IPO"), are capitalized. The deferred offering costs will be offset against IPO proceeds upon the consummation of the IPO. In the event the offering is terminated or suspended, deferred offering costs will be expensed. No amounts were deferred as of December 31, 2015 or 2016. As of June 30, 2017, the Company deferred \$2.4 million of offering costs, which are recorded as other long-term assets in the accompanying consolidated balance sheet.

**Cash, cash equivalents and restricted cash**

The Company considers all highly liquid investments with original or remaining maturities of 90 days or less at the date of purchase to be cash equivalents. Cash and cash equivalents are recorded at cost, which approximates fair value.

Restricted cash is included in other long-term assets on the consolidated balance sheets. The following table provides a reconciliation of cash, cash equivalents and restricted cash reported in the consolidated balance sheets that sum to the total of the amounts reported in the consolidated statements of cash flows (in thousands):

	<b>December 31,</b>		<b>June 30,</b>
	<b>2015</b>	<b>2016</b>	<b>2017</b>
			<b>(unaudited)</b>
Cash and cash equivalents	\$13,756	\$16,874	\$17,419
Restricted cash included in other long-term assets	257	265	270
<b>Total cash, cash equivalents, and restricted cash shown in the statement of cash flows</b>	<b>\$14,013</b>	<b>\$17,139</b>	<b>\$17,689</b>

Restricted cash represents amounts required for a contractual agreement with an insurer for the payment of potential health insurance claims, and term deposits for bank guarantees.

**Accounts receivable, net**

An allowance for doubtful accounts is recorded when amounts are determined to be uncollectible based on specific identification of customer circumstances, age of the receivable and other available information. Accounts are written off when it becomes apparent that such amounts will not be collected. Generally, the Company does not require collateral or charge interest on accounts receivable. Accounts receivable were reported net of an allowance for doubtful accounts of \$0.9 million and \$0.6 million at December 31, 2015 and 2016, respectively. Activity in the allowance for doubtful accounts was as follows (in thousands):

	<b>For the year ended</b>	
	<b>December 31,</b>	
	<b>2015</b>	<b>2016</b>
Balance, beginning of year	\$ (1,439)	\$ (937)
Provision charged to expense	(145)	(291)
Write-offs, net of recoveries	536	638
Effects of foreign currency translation	111	25
<b>Balance, end of year</b>	<b>\$ (937)</b>	<b>\$ (565)</b>

**Concentrations of credit risk**

The Company's financial instruments that are potentially subject to concentrations of credit risk consist primarily of cash and trade receivables. The risk with respect to trade receivables is partially mitigated by the diversity, both by geography and by industry, of the Company's customer base. The Company's accounts receivable are derived from sales to a large number of direct customers and resellers around the world. Sales to customers within the automotive industry accounted for 51% and 50%, respectively, of the Company's 2015 and 2016 revenue, with no other industry representing more than 10% of revenue. No individual customer accounted for 10% or more of revenue in the years ended December 31, 2015 or 2016.

**Inventory**

Inventory is stated at the lower of cost or market. Cost is determined using the first-in, first-out method. The valuation of inventory requires management to estimate excess inventory as well as inventory that is not of saleable quality. The determination of obsolete or excess inventory requires management to estimate market conditions and future demand for the Company's products.

Inventory consisted of the following (in thousands):

	<u>December 31,</u>		<u>June 30,</u>
	<u>2015</u>	<u>2016</u>	<u>2017</u>
			<b>(unaudited)</b>
Raw materials	\$ 790	\$ 570	\$ 546
Finished goods	2,241	1,507	1,913
Obsolescence and excess reserve	(956)	(850)	(770)
Total inventory	\$2,075	\$1,227	\$ 1,689

**Property and equipment, net**

Property and equipment are stated at cost, less accumulated depreciation and amortization. Equipment held under capital leases are stated at the present value of minimum lease payments less accumulated amortization. Depreciation is calculated using the straight-line method over the estimated useful lives of the assets. Leasehold improvements and assets acquired under capital leases are amortized over the lease term or the estimated useful life of the related asset or improvement, whichever is shorter.

Expenditures for maintenance and repairs are charged to expense in the period incurred. Major expenditures for betterments are capitalized when they meet the criteria for capitalization. When assets are retired or otherwise disposed of, the cost and accumulated depreciation are removed from the accounts and any resulting gain or loss is reflected in the consolidated statements of operations in the period realized.

**Software development costs**

Software development costs incurred prior to the establishment of technological feasibility are expensed as incurred. Technological feasibility is established upon the completion of a detailed program design. Capitalization of software development costs begins upon the establishment of technological feasibility and ends when the product is available for general release. Generally, the time between the establishment of technological feasibility and commercial release of software is short. As such, all internal software development costs have been expensed as incurred and included in research and development expense in the accompanying consolidated statements of operations.

***Impairment of long-lived assets***

Long-lived assets, such as property and equipment, and definite-lived intangible assets, including developed technology, and customer relationships, are reviewed for impairment whenever events or changes in circumstances indicate that the carrying amount of an asset may not be recoverable. If circumstances require a long-lived asset or asset group to be tested for possible impairment, the Company compares the undiscounted future cash flows expected to be generated by that asset or asset group to its carrying amount. If the carrying amount of the long-lived asset or asset group is not recoverable on an undiscounted cash flow basis, an impairment charge is recognized to the extent that the carrying amount exceeds its fair value. Fair value is determined through various valuation techniques, including discounted cash flow models and third-party independent appraisals. No impairment losses were recognized in 2015, 2016, or for the six months ended June 30, 2017.

***Goodwill and other indefinite-lived intangible assets***

Goodwill represents the excess of the consideration transferred for an acquired entity over the estimated fair values of the net tangible assets and the identifiable assets acquired. As described in Note 4—Acquisitions, the Company has recorded goodwill in connection with certain acquisitions. Goodwill and other indefinite-lived intangible assets are not amortized, but rather are reviewed for impairment annually or more frequently if facts or circumstances indicate that its carrying value may not be recoverable.

The Company has determined that there is one reporting unit with goodwill subject to goodwill impairment testing. An entity has the option to perform a qualitative assessment to determine whether it is more likely than not that the fair value of the reporting unit is less than its carrying amount prior to performing the quantitative two-step impairment test. The qualitative assessment evaluates various events and circumstances, such as macro-economic conditions, industry and market conditions, cost factors, relevant events and financial trends that may impact a reporting unit's fair value. If it is determined that the estimated fair value of the reporting unit is more likely than not less than its carrying amount, including goodwill, the two-step goodwill impairment test is required. Otherwise, no further analysis would be required.

If the two-step impairment test for goodwill is deemed necessary, this quantitative impairment analysis compares the fair value of the Company's reporting unit to its related carrying value. If the fair value of the reporting unit is less than its carrying amount, an indication of goodwill impairment exists and the Company must perform step two of the impairment test. Under step two, an impairment loss is recognized for any excess of the carrying amount of the reporting unit's goodwill over the implied fair value of that goodwill. The implied fair value of goodwill is determined by allocating the fair value of the reporting unit in a manner similar to a purchase price allocation and the residual fair value after this allocation is the implied fair value of the reporting unit goodwill. Fair value of the reporting units is determined using an income approach. The income approach is based on projected debt-free cash flows which are discounted to the present value using discount factors that consider the timing and risk of cash flows. The Company also takes into consideration a multiple of earnings valuation technique. The Company believes that this approach is appropriate because it provides a reasonable estimate of the price that would be received to sell the reporting unit in an orderly transaction between market participants at the measurement date. While there are inherent uncertainties related to the assumptions used in this analysis, the Company believes that this approach provides a reasonable estimate of fair value. If the fair value of the reporting unit exceeds its carrying amount, step two does not need to be performed.

The Company performs its annual impairment review of goodwill in the fourth quarter of each year and when a triggering event occurs between annual impairment dates. For 2015 and 2016, the Company performed a qualitative assessment of goodwill and determined that it was not more likely than not that the fair value of its

## [Table of Contents](#)

reporting unit with goodwill was less than the carrying amounts. Accordingly, the Company determined that its goodwill was not impaired.

### **Valuation of common stock**

Due to the absence of an active market for the Company's common stock, the Board of Directors, with the assistance of a third-party valuation specialist, determines the fair value of the Company's common stock. The valuation methodology includes estimates and assumptions including forecasts of future cash flows that require significant judgments. These valuations consider a number of objective and subjective factors, including the Company's actual operating and financial performance, external market conditions, performance of comparable publicly traded companies, comparable transactions, business developments, likelihood of achieving a liquidity event, such as an initial public offering or sale, and common stock transactions, among other factors. The Company utilized methodologies in accordance with the framework of the American Institute of Certified Public Accountants' Technical Practice Aid, *Valuation of Privately-Held Company Equity Securities issued as Compensation*, to estimate the fair value of its common stock. Significant changes to the key assumptions used in the valuations could result in different fair values of the Company's common stock at each valuation date.

### **Derivative financial instruments**

The Company may use derivative financial instruments, primarily interest rate swap contracts, to hedge its exposure to interest rate risk. Such derivative financial instruments are initially recorded at fair value on the date on which a derivative contract is entered into and are subsequently remeasured to fair value at period end. Any gains or losses arising from changes in fair value on derivative contracts during the year are recorded in other expense (income), net in the consolidated statement of operations. Hedge accounting has not been applied.

### **Income taxes**

The Company accounts for income taxes under the asset and liability method. Deferred tax assets and liabilities are recognized for the future tax consequences attributable to differences between the financial statement carrying amounts of existing assets and liabilities and their respective tax bases and for operating loss and tax credit carryforwards. Deferred tax assets and liabilities are measured using enacted tax rates expected to apply to taxable income in the years in which those temporary differences are expected to be recovered or settled. The effect of a change in tax rates on deferred tax assets and liabilities is recognized in income in the period that includes the enactment date. The Company records net deferred tax assets to the extent it believes that these assets will more likely than not be realized. These deferred tax assets are subject to periodic assessments as to recoverability and if it is determined that it is more likely than not that the benefits will not be realized, valuation allowances are recorded which increase the provision for income taxes. In making such determination, the Company considers all available positive and negative evidence, including historical taxable income, projected future taxable income, the expected timing and reversal of existing temporary differences and tax planning strategies. If based upon the evidence, it is more likely than not that the deferred tax asset will not be realized, a valuation allowance is recorded. A valuation allowance is recognized to reduce deferred tax assets to the amount that management believes is more likely than not to be realized.

The Company applies a more-likely-than-not recognition threshold to its accounting for tax uncertainties. The Company reviews all of its tax positions and makes determinations as to whether its tax positions are more likely than not to be sustained upon examination by the relevant taxing authorities. Only those benefits that have a greater than fifty percent likelihood of being sustained upon examination by taxing authorities are



## [Table of Contents](#)

recognized. Interest and penalties related to uncertain tax positions are recorded in the provision for income taxes in the consolidated statements of operations.

In November 2015, the Financial Accounting Standards Board ("FASB") issued Accounting Standards Update ("ASU") No. 2015-17, *Balance Sheet Classification of Deferred Taxes*, which eliminates the guidance in Topic 740, Income Taxes, that required an entity to separate deferred tax assets and liabilities between current and noncurrent amounts in a classified balance sheet. The amendments require that all deferred tax assets and liabilities of the same jurisdiction or a tax filing group, as well as any related valuation allowance, be offset and presented as a single noncurrent amount in a classified balance sheet. The standard is effective for annual periods beginning after December 15, 2016, and interim periods within those annual periods, and may be applied on either prospectively to all deferred tax liabilities and assets or retrospectively to all periods presented. Early adoption is permitted. The Company adopted this standard early for the year ended December 31, 2015. The adoption of this standard did not have a material impact on the Company's financial statements.

### **Research and development costs**

Research and development costs are expensed as incurred. Research and development expenses consist primarily of salaries and benefits of research and development employees and costs incurred related to the development of new software products and significant enhancements and engineering changes to existing software products.

### **Advertising costs**

Advertising costs are expensed as incurred. Advertising expenses were \$2.2 million and \$2.5 million for the years ended December 31, 2015 and 2016, respectively.

### **Mezzanine equity**

During the quarter ended June 30, 2017, the Company issued 200,000 shares of new class A common stock to a third party as partial consideration for the purchase of developed technology. These shares have a put right that can be exercised by the holder five years from date of purchase at \$12.50 per share that requires the shares to be recorded at fair value and classified as mezzanine equity in the consolidated balance sheet.

### **Stock-based compensation**

Employee stock-based awards, consisting of stock options expected to be settled by issuing shares of Class B Common Stock, are recorded as equity awards. The fair value of these awards on the date of grant is measured using the Black-Scholes option pricing model. The Company expenses the grant date fair value of its time-vested stock options subject to graded vesting using the straight-line method over the applicable service period.

Employee stock-based awards, consisting of stock options with repurchase features that allow them to be settled in cash at a purchase price that is less than the current fair value are considered liability-based awards. These awards are initially recorded at fair value and remeasured to fair value at the end of each reporting period until settled. During the quarter ended June 30, 2017, the Company changed its accounting policy to measure the fair value of its liability awards using the Black-Scholes option pricing model. The impact of the change in accounting policy was immaterial to the financial statements.

**Recent accounting guidance**

*Accounting standards adopted*

The Company adopted ASU No. 2014-15, *Presentation of Financial Statements—Going Concern*, effective for the year ended December 31, 2016. This update provides guidance regarding management’s responsibility to evaluate whether there exists substantial doubt about an organization’s ability to continue as a going concern and to provide related footnote disclosures in certain circumstances. The adoption did not have a material effect on the Company’s consolidated financial statements.

The Company adopted ASU No. 2015-03, *Simplifying the Presentation of Debt Issuance Costs (“ASU 2015-03”)*, effective for the year ended December 31, 2016. This update amended existing guidance to require that debt issuance costs related to a recognized debt liability be presented in the balance sheet as a direct reduction from the carrying amount of that debt liability, consistent with debt discounts. ASU 2015-03 was applied retrospectively and did not have a material effect on the Company’s consolidated financial statements.

The Company adopted ASU No. 2015-05, *Intangibles—Goodwill and Other—Internal-Use Software (Subtopic 350-40): Customer’s Accounting for Fees Paid in a Cloud Computing Arrangement (“ASU 2015-05”)*, effective for the year ended December 31, 2016. The amendments in this update provided guidance to customers about whether a cloud computing arrangement includes a software license. If a cloud computing arrangement includes a software license, then the customer should account for the software license element of the arrangement consistent with the acquisition of other software licenses. If a cloud computing arrangement does not include a software license, the customer should account for the arrangement as a service contract. The guidance did not change U.S. GAAP for a customer’s accounting for service contracts. ASU 2015-05 was applied retrospectively and did not have a material effect on the Company’s consolidated financial statements.

The Company adopted ASU No. 2015-16, *Business Combinations: Simplifying the Accounting for Measurement-Period Adjustments (“ASU 2015-16”)*, effective for the year ended December 31, 2016. The amendments in ASU 2015-16 eliminate the requirement to restate prior period financial statements for measurement period adjustments. The amendments also require that the cumulative impact of a measurement period adjustment (including the impact on prior periods) be recognized in the reporting period in which the adjustment is identified. The amendments for ASU 2015-16 were prospectively applied and did not have a material effect on the Company’s consolidated financial statements.

The Company adopted ASU No. 2016-18, *Statement of Cash Flows (Topic 230): Restricted Cash (“ASU 2016-18”)*, effective for all periods beginning after December 15, 2017. ASU 2016-18 clarifies the presentation of restricted cash and restricted cash equivalents in the statements of cash flows. Under ASU 2016-18 restricted cash and restricted cash equivalents are included with cash and cash equivalents when reconciling the beginning-of-period and end-of-period total amounts shown on the statements of cash flows. The Company early adopted ASU No 2016-18 in 2016 on a retrospective basis, and the adoption did not have a material effect on the Company’s consolidated financial statements.

The Company adopted ASU No. 2015-11, *Inventory: Simplifying the Measurement of Inventory*, ASU 2015-11, effective for fiscal years and interim periods beginning after December 15, 2016. ASU 2015-11 requires an entity to measure inventory within the scope at the lower of cost and net realizable value. Net realizable value is the estimated selling prices in the ordinary course of business, less reasonable predictable costs of completion, disposal and transportation. The Company adopted ASU No 2015-11 on January 1, 2017, on a prospective basis, and the adoption did not have a material effect on the Company’s consolidated financial statements.

## [Table of Contents](#)

### *Accounting standards not yet adopted*

**Revenue Recognition**—In May 2014, the FASB issued ASU No. 2014-09, *Revenue from Contracts with Customers* (“ASU 2014-09”). This standard outlines a single comprehensive model for entities to use in accounting for revenue arising from contracts with customers and supersedes most existing revenue recognition guidance under U.S. GAAP. The core principle of the guidance is that an entity should recognize revenue when it transfers promised goods or services to customers in an amount that reflects the consideration to which the company expects to be entitled in exchange for those goods or services. ASU 2014-09 also requires enhanced disclosures about the nature, amount, timing, and uncertainty of revenues and cash flows arising from contracts with customers. Entities have the option of using either a full retrospective or a modified retrospective approach for the adoption of the new standard. In August 2015, the FASB issued ASU 2015-14, *Revenue from Contracts with Customers: Deferral of the Effective Date* that defers the effective date of ASU 2014-09 for all entities by one year for public business entities. This ASU is effective for fiscal years beginning after December 15, 2017 including interim periods within that reporting period. For all other entities, including emerging growth companies, this ASU is effective for fiscal years beginning after December 15, 2018, and interim periods within annual periods beginning after December 15, 2019. Early adoption is permitted.

The Company is evaluating the use of either the retrospective or modified retrospective transition method and the timing of adopting this standard. Under existing U.S. GAAP, the Company does not have VSOE of fair value for PCS sold along with software products licenses; therefore, revenues for the software products licenses (including perpetual licenses), PCS and professional services, if applicable, are considered to be one accounting unit and, once all services have commenced, are recognized ratably over the remaining period of the arrangement (the longer of the contractual service term or PCS term). Under ASU 2014-09, the concept of assessing VSOE has been eliminated and the Company must estimate a fair value associated with each performance obligation within an arrangement. As a result, the Company expects the timing of revenue recognition to be accelerated because it anticipates that license revenue will be recognized at a point in time, rather than over time, which is its current practice. Generally, the license revenue component of an arrangement represents a significant portion of the overall fair value of a software arrangement. As a result, the Company expects the impact of adopting ASU 2014-09 to have a significant impact on the consolidated financial statements. The Company is currently evaluating the method of implementation and impact this standard will have on its consolidated financial statements.

**Financial Instruments**—In January 2016, the FASB issued ASU No. 2016-01, *Financial Instruments—Overall: Recognition and Measurement of Financial Assets and Financial Liabilities* (“ASU 2016-01”). This standard affects the accounting for equity instruments, financial liabilities under the fair value option and the presentation and disclosure requirements of financial instruments. The standard is effective for public entities for annual reporting periods beginning after December 15, 2017, including interim periods within those fiscal years. For all other entities, including emerging growth companies, ASU 2016-01 is effective for fiscal years beginning after December 21, 2018, and interim periods within fiscal years beginning after December 15, 2019. Early adoption is permitted. The Company is evaluating the impact of the adoption of ASU 2016-01 on its financial statements and related disclosures.

**Leases**—In February 2016, the FASB issued ASU No. 2016-02, *Leases* (“ASU 2016-02”). This standard amends various aspects of existing accounting guidance for leases, including the recognition of a right-of-use asset and a lease liability on the balance sheet for all leases with terms longer than 12 months. Leases will be classified as either finance or operating, with classification affecting the pattern of expense recognition in the income statement. This standard also introduces new disclosure requirements for leasing arrangements. The standard is effective for public entities for annual reporting periods, and interim periods within those annual reporting periods, beginning after December 15, 2018. For all other entities, including emerging growth companies, ASU 2016-02 is effective for fiscal years beginning after December 15, 2019, including interim periods within those

## [Table of Contents](#)

fiscal years beginning after December 15, 2020. Early adoption is permitted. The new standard must be adopted using a modified retrospective approach, and provides for certain practical expedients. The Company is evaluating the impact of the adoption of ASU 2016-02 on its financial statements and related disclosures.

*Employee Share-Based Payment Accounting*—In March 2016, FASB issued ASU No. 2016-09, *Improvements to Employee Share-Based Payment Accounting* (“ASU 2016-09”). This standard involves several aspects of the accounting for share-based payment transactions, including the income tax consequences, classification of awards as either equity or liabilities and classification on the statement of cash flows. The standard is effective for public entities for annual reporting periods, and interim periods within those annual periods, beginning after December 15, 2016. For all other entities, including emerging growth companies, ASU 2016-09 is effective for annual periods beginning after December 15, 2017 and interim periods within fiscal years beginning after December 15, 2018. The method of adoption is dependent on the specific aspect of accounting addressed in this new guidance. The Company is evaluating the impact of the adoption of ASU 2016-09 on its financial statements and related disclosures.

*Cash Classification*—In August 2016, the FASB issued ASU No. 2016-15, *Statement of Cash Flows (Topic 230): Classification of Certain Cash Receipts and Cash Payments* (“ASU 2016-15”), to improve financial reporting in regards to how certain transactions are classified in the statement of cash flows. ASU 2016-15 provides guidance for targeted changes with respect to how cash receipts and cash payments are classified in the statements of cash flows, with the objective of reducing diversity in practice. The standard is effective for public entities for annual reporting periods beginning after December 15, 2017, including interim periods within those fiscal years. For all other entities, including emerging growth companies, ASU 2016-15 is effective for fiscal years beginning after December 15, 2018, and interim periods within fiscal years beginning after December 15, 2019. Early adoption is permitted. The Company is evaluating the impact of the adoption of ASU No. 2016-15 on its financial statements and related disclosures.

*Business Combinations*—In January 2017, the FASB issued ASU No. 2017-01, *Business Combinations (Topic 805): Clarifying the Definition of a Business* (“ASU 2017-01”). This update narrows the definition of a business. If substantially all the fair value of the gross assets acquired is concentrated in a single identifiable asset or group of similar identifiable assets, the acquiree may not be considered a business. The update also requires a business to include an input and a substantive process that significantly contributes to the ability to create outputs. This definition is expected to reduce the number of acquisitions accounted for as business combinations, which will impact the accounting treatment of certain items, including the accounting treatment of contingent consideration and transaction expenses. The standard is effective for public entities for annual reporting periods beginning after December 15, 2017, including interim periods within those fiscal years. For all other entities, including emerging growth companies, ASU 2017-01 is effective for annual periods beginning after December 15, 2018, and interim periods within annual periods beginning after December 15, 2019. Early adoption is permitted and the update will be applied prospectively. The effect of the implementation will depend upon the nature of the Company’s future acquisitions.

### **3. Fair value measurements**

The accounting guidance for fair value, among other things, defines fair value, establishes a consistent framework for measuring fair value and expands disclosure for each major asset and liability category measured at fair value on either a recurring or nonrecurring basis. Fair value is defined as the price that would be received to sell an asset or paid to transfer a liability (an exit price) in an orderly transaction between market participants at the reporting date. The framework for measuring fair value consists of a three-level valuation hierarchy that prioritizes the inputs to valuation techniques used to measure fair value based upon whether such inputs are observable or unobservable. Observable inputs reflect market data obtained from

## [Table of Contents](#)

independent sources, while unobservable inputs reflect market assumptions made by the reporting entity. The three-level hierarchy for the inputs to valuation techniques is briefly summarized as follows:

*Level 1*— Quoted prices in active markets for identical assets and liabilities at the measurement date;

*Level 2*— Observable inputs, other than the quoted prices in active markets, that are observable either directly or indirectly; and

*Level 3*— Unobservable inputs in which there is little or no market data, which require the reporting entity to develop its own assumptions.

An asset's or liability's fair value measurement level within the fair value hierarchy is based on the lowest level of any input that is significant to the fair value measurement. Valuation techniques used need to maximize the use of observable inputs and minimize the use of unobservable inputs.

### **Items measured at fair value on a recurring basis**

The following table sets forth a summary of the changes in the fair value of the Company's Level 3 financial liabilities (in thousands):

	<b>Liability for new Class A redeemable common shares</b>	<b>Liability for stock-based compensation awards</b>
Balance at December 31, 2014	\$ 6,172	\$ 11,654
Shares issued upon exercise of stock options	609	—
Repurchase of shares	(218)	—
Forfeitures of stock options	—	(188)
Exercise of stock options	—	(687)
Change in fair value	129	254
Balance at December 31, 2015	6,692	11,033
Shares issued upon exercise of stock options	1,841	—
Repurchase of shares	(79)	—
Exercise of stock options	—	(2,084)
Forfeitures of stock options	—	(110)
Change in fair value	2,178	2,765
Balance at December 31, 2016	10,632	11,604
Shares issued upon exercise of stock options (unaudited)	88	—
Exercise of stock options (unaudited)	—	(216)
Forfeitures of stock options (unaudited)	—	(54)
Change in fair value (unaudited)	6,131	7,763
Balance at June 30, 2017 (unaudited)	\$ 16,851	\$ 19,097

The carrying value of cash and cash equivalents, accounts receivable and accounts payable approximate fair value due to their short maturities. Interest on the Company's long-term debt is at a variable rate, and as such the debt obligation outstanding approximates fair value.

The carrying value of the Company's derivative financial instruments are measured at fair value on a recurring basis. The fair value of derivatives is determined based on inputs derived from or corroborated by observable market data pertaining to relevant interest rates and is considered a level 2 fair value measurement. See Note 9—Financial instruments for additional information regarding the use and fair value of derivatives.

## 4. Acquisitions

### **Carriots S.L. (unaudited)**

In May 2017, the Company acquired 100% of the shares of Carriots S.L. ("Carriots") for \$3.6 million cash, \$2.7 million notes payable, and 80,000 shares of the Company's new Class A voting stock. Carriots is an Internet of Things ("IoT") Cloud platform that allows easy development of new IoT enabled products. Carriots complements Altair's other product suites to provide a comprehensive solution for customers to design and implement IoT enabled products.

The following table summarizes the consideration transferred to acquire Carriots and the amounts of identified assets acquired and liabilities assumed at the acquisition date (in thousands):

Fair value of consideration transferred	\$ 6,657
Recognized amounts of identifiable assets acquired and liabilities assumed:	
Deferred tax assets	394
Other assets	472
Trade names	252
Developed technology (4-year life)	1,317
Customer relationships (7-year life)	296
Accounts payable and other liabilities	(1,015)
Total net identifiable assets acquired and liabilities assumed	1,716
Goodwill	\$ 4,941

The allocation of the consideration transferred to the assets and the liabilities assumed is substantially complete yet finalization of the valuation is still in process.

### **CEDRAT S.A.**

In April 2016, the Company completed the acquisition of all of the common shares of CEDRAT S.A. ("CEDRAT") for \$3.7 million in cash and \$1.4 million in a note payable. CEDRAT is in the field of simulating low-frequency electromagnetics and thermal simulations for electric motor design. The acquisition of CEDRAT and its Flux technology complements Altair's broad software coverage, including Altair's comprehensive set of solvers for the rapidly growing electromagnetic market.

## [Table of Contents](#)

The following table summarizes the consideration transferred to acquire CEDRAT and the amounts of identified assets acquired and liabilities assumed at the acquisition date (in thousands):

Fair value of consideration transferred	\$ 5,122
Recognized amounts of identifiable assets acquired and liabilities assumed:	
Cash	\$ 363
Accounts receivable	542
Income tax receivable	995
Other assets	206
Trade names	269
Developed technology (4-year life)	1,085
Customer relationships (7-year life)	938
Accounts payable and other liabilities	(2,742)
Deferred revenue	(290)
Total net identifiable assets acquired and liabilities assumed	1,366
Goodwill <sup>(1)</sup>	\$ 3,756

(1) The goodwill included \$3.5 million that was tax deductible.

### **Other business acquisitions**

During the years ended December 31, 2015 and 2016, the Company completed other business acquisitions that were individually and in the aggregate insignificant. The Company has accounted for all of its acquisitions using the acquisition method. The operating results of each acquisition have been included in the consolidated financial statements since the respective dates of acquisition.

The combined consideration transferred related to the 2015 acquisitions was \$4.4 million, which consisted of cash of \$2.9 million, equity of \$0.7 million and notes of \$0.8 million. The total consideration transferred was allocated to assets and liabilities of each acquisition based on management's estimates of the fair values of the assets acquired and liabilities assumed. The allocation included \$1.9 million to intangibles, consisting of developed technology, customer relationships, and trade names and \$2.9 million to goodwill, of which \$1.0 million was tax deductible.

The combined purchase price related to the 2016 acquisitions, excluding CEDRAT, was \$6.0 million, which consisted of cash of \$3.1 million and notes payable of \$2.9 million. The total consideration transferred was allocated to assets and liabilities of each acquisition based on management's estimates of the fair values of the assets acquired and liabilities assumed. The allocation included \$2.3 million to intangibles, consisting of developed technology, customer relationships, and trade names and \$4.1 million to goodwill. There was no taxable goodwill associated with the Company's other 2016 acquisitions.

For each of its acquisitions the Company typically engages a third party valuation firm to assist the Company in valuing certain assets and liabilities acquired.

## 5. Property and equipment, net

Property and equipment consists of the following (in thousands):

	Estimated useful lives	December 31,		June 30,
		2015	2016	2017
				(unaudited)
Land	Indefinite	\$ 3,994	\$ 7,994	\$ 7,994
Building and improvements	5-39 years	14,924	14,956	14,994
Computer equipment and software	3-5 years	25,324	27,461	30,143
Office furniture and equipment	5-15 years	5,534	5,306	5,551
Leasehold improvements	*	5,245	5,397	5,586
Total property and equipment		55,021	61,114	64,268
Less: accumulated depreciation and amortization		29,642	31,406	34,819
Property and equipment, net		\$25,379	\$29,708	\$ 29,449

\* Shorter of lease term or estimated useful life, generally ranging from five to ten years.

In November 2016, the Company purchased land adjacent to our corporate headquarters for future expansion of our facilities for \$4.0 million.

Depreciation expense was \$5.8 million and \$6.7 million for the years ended December 31, 2015 and 2016 and \$3.4 million and \$3.0 million for the six months ended June 30, 2016 and 2017, respectively.

## 6. Goodwill and other intangible assets

### Goodwill

The changes in the carrying amount of goodwill, which is attributable to the Software reporting segment, are as follows (in thousands):

Balance at December 31, 2014	\$28,859
Acquisitions	2,897
Effects of foreign currency translation	(2,516)
Balance at December 31, 2015	29,240
Acquisitions	7,855
Effects of foreign currency translation	(470)
Balance at December 31, 2016	36,625
Acquisitions (unaudited)	4,941
Effects of foreign currency translation (unaudited)	2,100
Balance at June 30, 2017 (unaudited)	\$43,666



[Table of Contents](#)**Other intangible assets**

A summary of other intangible assets is shown below (in thousands):

		December 31, 2015		
	Weighted average amortization period	Gross carrying amount	Accumulated amortization	Net carrying amount
<i>Definite-lived intangible assets:</i>				
Developed technology	4 years	\$ 7,179	\$ 2,433	\$ 4,746
Customer relationships	7 years	7,323	4,051	3,272
Noncompete agreements	5 years	824	824	—
Other intangibles	10 years	105	30	75
Total definite-lived intangible assets		15,431	7,338	8,093
<i>Indefinite-lived intangible assets:</i>				
Trade names		1,297	—	1,297
Total other intangible assets		\$ 16,728	\$ 7,338	\$ 9,390

		December 31, 2016		
	Weighted average amortization period	Gross carrying amount	Accumulated amortization	Net carrying amount
<i>Definite-lived intangible assets:</i>				
Developed technology	4 years	\$ 10,631	\$ 5,034	\$ 5,597
Customer relationships	7 years	8,646	4,977	3,669
Noncompete agreements	5 years	824	824	—
Other intangibles	10 years	117	40	77
Total definite-lived intangible assets		20,218	10,875	9,343
<i>Indefinite-lived intangible assets:</i>				
Trade names		1,825		1,825
Total other intangible assets		\$ 22,043	\$ 10,875	\$ 11,168

		June 30, 2017		
	Weighted average amortization period	Gross carrying amount	Accumulated amortization	Net carrying amount (unaudited)
<i>Definite-lived intangible assets:</i>				
Developed technology	4 years	\$ 16,966	\$ 6,845	\$ 10,121
Customer relationships	7 years	9,155	5,540	3,615
Noncompete agreements	5 years	824	824	—
Other intangibles	10 years	124	45	79
Total definite-lived intangible assets		27,069	13,254	13,815
<i>Indefinite-lived intangible assets:</i>				
Trade names		2,197		2,197
Total other intangible assets		\$ 29,266	\$ 13,254	\$ 16,012

Amortization expense related to amortizing intangible assets was \$2.6 million and \$3.3 million for the years ended December 31, 2015 and 2016, respectively, and \$1.5 million and \$2.1 million for the six months ended June 30, 2016 and 2017, respectively.

Estimated amortization expense for the next five years as of December 31, 2016 is as follows (in thousands):

Year ending	
December 31, 2017	\$3,527
December 31, 2018	\$2,641
December 31, 2019	\$1,440
December 31, 2020	\$1,035
December 31, 2021	\$ 428

## 7. Debt

The carrying value of debt is as follows (in thousands):

	December 31,		June 30,
	2015	2016	2017
			(unaudited)
<i>Secured Credit Agreement:</i>			
Revolving Credit Facility	\$11,513	\$27,355	\$ 18,018
Term Loan A	67,122	57,500	52,500
Note payable, equipment	3,296	—	—
Obligations held under capital leases (Note 18)	310	196	165
Other borrowings	1,118	330	523
Total debt	83,359	85,381	71,206
Less: unamortized debt issuance costs	182	140	111
Less: current portion of long-term debt	13,817	10,435	10,601
Long-term debt, net of current portion	\$69,360	\$74,806	\$ 60,494

## [Table of Contents](#)

On June 14, 2017, we entered into an amended and restated credit agreement with JPMorgan Chase Bank, N.A., as administrative agent, which restated our prior credit agreement, as amended, in its entirety (“2017 Credit Agreement” or the “Credit Agreement”). This amendment was administrative in nature and did not change amounts, terms, or rates. On September 28, 2017, the Credit Agreement was amended to facilitate the Company’s acquisition of Runtime. See Note 21—Subsequent events (unaudited) for additional information regarding the acquisition of Runtime.

### **Secured credit agreement**

At December 31, 2015, the Company’s credit agreement consisted of a \$67.1 million term loan (“Term Loan A”), a \$20.0 million revolving commitment (“Revolving Credit Facility”) and a \$1.0 million ancillary facility (collectively, the “2013 Credit Agreement”). The Company was required to make quarterly principal payments on Term Loan A and any outstanding balance was to be paid in full on the maturity date of December 18, 2018.

On April 18, 2016, the Company entered into an Amended and Restated Credit Agreement (“2016 Credit Agreement”) with JPMorgan Chase Bank, N.A., as administrative agent, which restated in its entirety the 2013 Credit Agreement. The 2016 Credit Agreement originally consisted of a \$65.0 million term loan (“Term Loan A”) and a \$35.0 million revolving commitment (“Revolving Credit Facility”). In November 2016, the 2016 Credit Agreement was amended pursuant to which the Royal Bank of Canada became a lender thereunder and the commitment under the Revolving Credit Facility was increased to \$60.0 million. Included in the Revolving Credit Facility are a \$5.0 million swingline subfacility, and a letter of credit subfacility. In addition, the 2016 Credit Agreement provides for a \$4.0 million ancillary facility adding additional borrowing capacity. In connection with the 2016 Credit Agreement, the Company updated the December 31, 2015 balance sheet to reflect the reclassification from short-term to long-term debt for the revolving credit facility and a portion of the long-term debt to reflect updated debt service requirements.

As of June 30, 2017, the Company’s Credit Agreement consisted of a \$52.5 million term loan (“Term Loan A”), a \$60.0 million revolving commitment (“Revolving Credit Facility”) and a \$4.0 million ancillary facility. Included in the Revolving Credit Facility are a \$5.0 million swingline subfacility, and a letter of credit subfacility.

Interest rates on borrowings outstanding under the Credit Agreement range from (i) an adjusted LIBO rate ((the London Interbank Offered Rate multiplied by the Statutory Reserve Rate)) plus 1.5% to 2.0% (dependent upon the Company’s leverage ratio) for Eurodollar-based borrowings or (ii) the Commercial Bank Floating Rate (“CBFR”) (the greater of the Prime Rate or the adjusted LIBO rate plus 2.5%) for CBFR borrowings. The Company can elect the type of borrowing for each loan.

#### **Term loan facilities**

At December 31, 2016 and June 30, 2017, the Company was required to make quarterly principal payments on Term Loan A of \$2.5 million in 2017, 2018 and March 2019. Any outstanding principal balance is to be paid in full on the maturity date of April 18, 2019. At December 31, 2015 and 2016, respectively, there was \$67.1 million and \$57.5 million outstanding under Term Loan A at an interest rate of 2.2% and 2.6% based on the LIBO rate and the applicable margin.

At June 30, 2017, there was \$52.5 million outstanding under Term Loan A.

#### **Revolving credit facilities**

As of December 31, 2015 and 2016 and June 30, 2017, respectively, the Company had \$11.5 million, \$27.4 million, and \$18.0 million outstanding under the Revolving Credit Facility and there was \$8.5 million, \$32.6 million and \$42.0 million available for future borrowing. The Revolving Credit Facility is available for general corporate purposes, including working capital, capital expenditures, and permitted acquisitions. All

## [Table of Contents](#)

borrowings under the Revolving Credit Facility are due on the termination date in April 2019. The weighted-average interest rate on borrowings under the Revolving Credit Facility was 3.3% and 2.6% for the years ended December 31, 2015 and 2016, respectively.

The Company pays quarterly commitment fees of 0.25% per annum on the unused portion of the Revolving Credit Facility. Fees with respect to letters of credit accrue daily based on the stated amount of each outstanding letter of credit at the adjusted LIBO rate plus 1.5% to 2.0% (dependent upon the Company's leverage ratio).

### ***Debt covenants***

The Credit Agreement contains a number of covenants that, among other things, restrict, subject to certain exceptions, the Company's ability to incur additional indebtedness; create liens on assets; make investments, loans, advances or acquisitions; pay dividends or other distributions; redeem or repurchase certain equity interests; guarantee the obligations of others; and change the business conducted by the Company. In addition, the Credit Agreement contains financial covenants relating to minimum liquidity of \$20.0 million, maintaining a minimum debt service coverage ratio of 1.3 to 1.0 and maximum leverage ratio of 3.0 to 1.0, as defined in the Credit Agreement. At December 31, 2016 and June 30, 2017, the Company was in compliance with all such financial covenants.

### ***Collateral and guarantees***

The Credit Agreement is unconditionally guaranteed by the Company and all existing and subsequently acquired controlled domestic subsidiaries. Any obligations of foreign subsidiaries are unconditionally guaranteed by the Company and certain foreign subsidiaries. Furthermore, the Credit Agreement is collateralized by a first priority, perfected security interest in, and mortgages on, substantially all tangible assets of the Company. In addition, foreign borrowings under the credit agreement will be secured by assets of the foreign borrowers.

### **Equipment term loan**

In 2013, the Company entered into a promissory note for \$6 million with a commercial lender to finance the purchase of manufacturing equipment. The note required interest at 5.25% per annum with monthly payments of principal and interest. The note was paid in full in June 2016 from borrowings under the Revolving Credit Facility.

### **Other borrowings**

Other borrowings includes notes payable with U.S. based financial institutions. The notes total \$1.0 million and \$0.3 million at December 31, 2015 and 2016, respectively. The terms of the notes are three to five years and bear interest rates that range from 1.9% to 5.25%.

The Company has available overdraft and line of credit facilities in several countries in which it operates. These credit facilities are with various domestic and international banks and are at quoted market rates. The Company had \$3.3 million of availability under these facilities and there were \$0.3 million of commitments at December 31, 2015. The Company had \$3.5 million of availability under these facilities and there were no outstanding commitments at December 31, 2016.

[Table of Contents](#)**Scheduled maturities of long-term debt**

At December 31, 2016, future maturities of long-term debt, excluding capital leases, were as follows (in thousands):

<b>Year ending December 31,</b>	
2017	\$10,304
2018	10,026
2019	64,855
Total	<u>\$85,185</u>

**8. Other liabilities**

The following table provides the details of other accrued expenses and current liabilities (in thousands):

	<b>December 31,</b>		<b>June 30,</b>
	<b>2015</b>	<b>2016</b>	<b>2017</b>
			<b>(unaudited)</b>
Accrued VAT	\$ 3,747	\$ 3,928	\$ 4,310
Accrued royalties	1,490	1,583	1,811
Non-income tax liabilities	1,364	739	276
Billings in excess of cost	1,315	1,021	550
Related party liabilities	1,349	1,045	548
Defined contribution plan liabilities	1,144	1,139	1,011
Income taxes payable	1,381	2,156	74
Self-insurance and other insurance reserves	646	764	787
Obligations for acquisition of businesses	250	2,649	3,576
Other current liabilities	4,366	3,921	5,840
Total	<u>\$17,052</u>	<u>\$18,945</u>	<u>\$ 18,783</u>

The following table provides the details of other long-term liabilities (in thousands):

	<b>December 31,</b>		<b>June 30,</b>
	<b>2015</b>	<b>2016</b>	<b>2017</b>
			<b>(unaudited)</b>
Pension and other post retirement liabilities	\$ 4,436	\$ 5,959	\$ 6,724
Deferred tax liabilities	1,100	1,379	298
Other liabilities	7,340	9,776	6,364
Total	<u>\$12,876</u>	<u>\$17,114</u>	<u>\$ 13,386</u>

**9. Financial instruments**

The Company is exposed to certain financial market risks related to its ongoing business operations. The primary risks the Company manages through derivative financial instruments and hedging activities are foreign currency exchange rate risk and interest rate risk. Derivative financial instruments and hedging activities can be utilized to protect the Company's cash flow from adverse movements in foreign currency exchange rates and to manage interest costs. Although the Company is exposed to credit loss in the event of nonperformance by the counterparty to the derivative financial instruments, the Company attempts to limit this exposure by

## [Table of Contents](#)

entering into agreements directly with major financial institutions that meet the Company's credit standards and that are expected to fully satisfy their obligations under the contracts.

### ***Interest rate swaps***

Interest rate exposures are reviewed periodically and the Company may enter into interest rate swap agreements to manage its exposure. The Company's exposure to interest rate risk arises primarily from changes in the LIBO rate. The Company will hold these derivatives for economic purposes but does not designate these derivatives to obtain hedge accounting treatment. As such, gains or losses on these contracts (including contracts that do not qualify for hedge accounting under ASC 815), are reported in earnings immediately as Other expense (income), net. These contracts limit exposure to changes in interest payments associated with variable rate debt. However, as the change in the fair value of the interest rate swaps is impacted by both realized and unrealized gains and losses on the contracts, the amount recognized in earnings may not offset the changes in the variability of interest expense during a given period.

As of December 31, 2015, and 2016, the Company had a notional value of \$4.8 million and \$4.5 million, respectively, in outstanding interest rate swaps. As of June 30, 2017, the Company had an interest rate swap outstanding with a notional value of \$4.5 million. This interest rate swap matures at various dates through December 23, 2019.

On January 27, 2014, the Company paid a nominal fee for an interest rate cap that terminated on December 31, 2015, to protect against rising interest rates associated with the Company's term loan. The notional amount on the interest rate cap was \$40 million and protected the Company in the event the LIBO rate rose above 1.5%.

### ***Foreign currency derivatives***

The Company sells its products (and incurs costs) in countries throughout the world. As a result, it is exposed to fluctuations in foreign currency exchange rates. Foreign currency exposures are reviewed on a periodic basis and any natural offsets are considered prior to entering into a derivative financial instrument. The Company could enter into foreign exchange contracts to hedge portions of its foreign currency denominated forecasted revenues, purchases and the subsequent cash flows after considering natural offsets within the consolidated group. The Company will hold these derivatives for economic purposes but does not designate these derivatives to obtain hedge accounting treatment. As such, gains or losses on these contracts (including contracts that do not qualify for hedge accounting under ASC 815), are reported in earnings immediately and are substantially offset by the effect of the revaluation of the underlying foreign currency denominated transactions. There were no foreign exchange contracts outstanding at December 31, 2015 or 2016 or June 30, 2017.

### ***Derivative instruments***

The fair value of the Company's derivative instruments as of December 31, 2015 and 2016 was a liability of \$0.5 million and \$0.3 million, respectively.

### ***Credit-risk-related contingent features***

The Company has entered into International Swaps and Derivatives Association ("ISDA") agreements with its significant derivative counterparty. These agreements provide bilateral netting and offsetting of accounts that are in a liability position with those that are in an asset position. These agreements do not require the Company to maintain a minimum credit rating in order to be in compliance and do not contain any margin call provisions or collateral requirements that could be triggered by derivative instruments in a net liability position. As of December 31, 2016, the Company had not and was not required to post any collateral to support its derivatives in a liability position.

## 10. Stockholders' deficit

### *Class A and Class B common stock*

Prior to the Recapitalization (as described below), the Company's authorized common stock consisted of 99,279,884 shares of no par, Class A Voting Common Stock and 25,153,872 shares of no par, Class B Nonvoting Common Stock. Each class of common stock had equal and identical rights, preferences and limitations, other than voting. The holders of old Class A common stock were entitled to one vote per share on all matters submitted to the stockholders for a vote and holders of old Class B common stock had no voting rights.

### *Recapitalization*

On April 3, 2017, the Company completed a recapitalization (the "Recapitalization") of its capital stock by filing a certificate of amendment to its articles of incorporation with the State of Michigan pursuant to which: (i) each share of the Company's Class A voting common stock, or old Class A shares, automatically converted into one share of new Class B voting common stock entitled to ten votes per share; and (ii) each share of the Company's Class B non-voting common stock, or old Class B shares, automatically converted into one share of new Class A voting common stock entitled to one vote per share, in each case, without any further action on the part of the holders thereof.

Subsequent to the Recapitalization, the Company's authorized common stock consists of 76,000,000 shares no par, Class A Common Stock and 44,000,000 shares of no par, Class B Common Stock.

The holders of Class A and Class B common stock are entitled to dividends at the sole discretion of the Board of Directors. No common stock dividends were declared or paid in 2015 and 2016.

In October 2015, the Company acquired Altair Bellingham, LLC from significant stockholders of the Company for cash of \$0.7 million, which was paid in February 2016. This transaction was reported as a return of capital for the year ended December 31, 2015.

In December 2013, the Company issued warrants to purchase 3,000,000 shares, subject to certain terms and conditions, at an exercise price of \$4.50 per share as part of an old Class A Stock repurchase from a single investor. The warrants expired in December 2015 without having been exercised.

## 11. Stock-based compensation

### *2001 stock-based compensation plans*

#### *Nonqualified stock option plan*

In 2001, the Company established the Nonqualified Stock Option Plan ("NSO Plan") under which 6,347,840 stock options with an exercise price of \$.000025 remain outstanding at December 31, 2016. The NSO Plan was terminated in 2003. Stock options under the NSO plan were immediately vested and have a contractual term of 35 years from the date of grant. The outstanding awards will continue to be governed by their existing terms under the NSO Plan. The NSO Plan is accounted for as an equity plan.

[Table of Contents](#)

The following table summarizes the stock option activity under the NSO Plan:

	<b>Number of options</b>	<b>Weighted average exercise price per share</b>	<b>Weighted average remaining contractual term (years)</b>
Outstanding at January 1, 2016	9,090,444	\$ 0.000025	21 years
Granted	—	—	
Exercised	(2,742,604)	\$ 0.000025	
Forfeited	—	\$ —	
Outstanding at December 31, 2016	6,347,840	\$ 0.000025	20 years
Granted (unaudited)	—	—	
Exercised (unaudited)	—	\$ —	
Forfeited (unaudited)	—	\$ —	
Outstanding at June 30, 2017 (unaudited)	6,347,840	\$ 0.000025	20 years
Exercisable at December 31, 2016	6,347,840	\$ 0.000025	20 years
Exercisable at June 30, 2017 (unaudited)	6,347,840	\$ 0.000025	20 years

*Incentive and nonqualified stock-based plan*

Also in 2001, the Company established the Incentive and Nonqualified Stock-based Plan ("ISO Plan") which was terminated in 2011 and was authorized to issue nonqualified stock options ("NQSO") and incentive stock options ("ISO") totaling 11,153,872 shares of old Class B, nonvoting stock. The NQSO grants could be issued at less than the fair market value at date of grant under the terms of the ISO Plan, while ISO grants were issued at a price equal to or greater than the fair market value at date of grant. Options generally vest over a two to three year period. All options have a contractual term of ten years from the date of grant. At December 31, 2015 and 2016, and June 30, 2017, there were 3,623,752, 2,972,744 and 2,931,380 options outstanding, respectively, under the ISO Plan.

Options granted under the ISO Plan are accounted for as liability awards as the terms of the awards could require or allow repurchase of the shares at amounts different than fair value. The Company made the accounting policy election to use the intrinsic value method of accounting to determine stock-based compensation liabilities for these awards. During the quarter ended June 30, 2017, the Company changed its accounting policy for this plan to measure the fair value of its liability awards using the Black-Scholes option pricing model. The impact of the change in accounting policy was immaterial to the financial statements.

The ISO Plan also includes stock-based compensation liability for 1,742,404 and 2,340,596 of old Class B shares outstanding at December 31, 2015 and 2016, respectively, and 2,359,960 of new Class A shares outstanding at June 30, 2017, resulting from the Company's call feature with an exercise price that may be set at less than the fair market value at date of grant under the terms of the ISO Plan. The Company utilized fair value of the outstanding old Class B shares and the new Class A shares to determine the stock-based compensation liabilities for these shares, based on the respective dates.



[Table of Contents](#)

The following table summarizes the stock option activity under the 2001 Stock-based compensation plans for the periods indicated as follows:

	Number of options	Weighted average exercise price per share	Weighted average remaining contractual term (years)
Outstanding at December 31, 2015	3,623,752	\$ 0.57	3.8
Granted	—	—	
Exercised	(616,824)	\$ 0.24	
Expired	(15,612)	\$ 0.23	
Forfeited	(18,572)	\$ 0.53	
Outstanding at December 31, 2016	2,972,744	\$ 0.64	3.4
Granted (unaudited)	—	—	
Exercised (unaudited)	(33,200)	\$ 0.64	
Forfeited (unaudited)	(8,164)	\$ 0.51	
Outstanding at June 30, 2017 (unaudited)	2,931,380	\$ 0.64	2.9
Exercisable at December 31, 2016	2,972,744	\$ 0.64	3.4
Exercisable at June 30, 2017 (unaudited)	2,931,380	\$ 0.64	2.9

The total intrinsic value of the ISO Plan stock options exercised during the years ended December 31, 2015 and 2016 was \$0.7 million and \$2.7 million, respectively.

**2012 stock-based compensation plans**

During 2012, the Company established the 2012 Incentive and Nonqualified Stock Option Plan ("2012 Plan") which permits the issuance of 5,200,000 shares of old Class B Nonvoting Common Stock for the grant of nonqualified stock options ("NQSO") and incentive stock options ("ISO") for management, other employees, and board members of the Company. The options are issued at a price equal to or greater than fair market value at date of grant. All options have a contractual term of 10 years from date of grant.

The 2012 Plan is accounted for as an equity plan. For those options expected to vest, compensation expense is recognized on a straight-line basis over a four year period, the total requisite service period of the awards. Compensation expense related to the 2012 Plan was \$0.6 million and \$0.6 million for the years ended December 31, 2015 and 2016, respectively.

[Table of Contents](#)

The following table summarizes the stock option activity under the 2012 Plan for the periods indicated as follows:

	Number of options	Weighted average exercise price per share	Weighted average remaining contractual term (years)
Outstanding at December 31, 2015	1,811,820	\$ 3.03	8.2
Granted	135,952	\$ 3.90	
Exercised	(124,720)	\$ 2.48	
Forfeited	(25,800)	\$ 3.23	
Outstanding at December 31, 2016	1,797,252	\$ 3.13	7.5
Granted (unaudited)	608,948	\$ 5.18	
Exercised (unaudited)	(174,492)	\$ 2.61	
Forfeited (unaudited)	(22,100)	\$ 3.98	
Outstanding at June 30, 2017 (unaudited)	2,209,608	\$ 3.73	7.8
Exercisable at December 31, 2016	1,059,676	\$ 2.86	6.9
Exercisable at June 30, 2017 (unaudited)	917,772	\$ 2.94	6.5

Total compensation cost related to nonvested awards not yet recognized as of December 31, 2016 totaled \$0.9 million, and is expected to be recognized over a weighted average period of 2.4 years.

The Company measures the fair value of its equity awards on the date of grant using the Black-Scholes option pricing model. This valuation model requires the Company to make certain estimates and assumptions, including assumptions related to the expected price volatility of the Company's stock, the period under which the options will be outstanding, the rate of return on risk-free investments, and the expected dividend yield for the Company's stock.

The weighted average assumptions used in the Black-Scholes option pricing model used to calculate the fair value of options granted during the year ended December 31, 2015 and 2016, and six months ended June 30, 2017 were as follows:

	2015 grants	2016 grants	2017 grants (unaudited)
Weighted average grant date fair value per share	\$ 1.43	\$ 1.42-\$1.65	\$ 1.86
Expected volatility	37%	37%	34%
Expected term (in years)	6.25	5.75-6.25	5.75-6.25
Risk-free interest rate	1.98%	1.37%-1.79%	2.02%
Expected dividend yield	0%	0%	0%

The Company's equity value was estimated utilizing a combination of the Discounted Cash Flow Method under the Income Approach, the Guideline Public Company Method, and the Transaction Method under the Market Approach. The equity value is used to derive the fair value per share which is used as an input in the Black Scholes option pricing model. The estimated volatility was derived using the historical volatility of the returns of comparable publicly traded companies. The risk-free rate was based on U.S. Treasury zero-coupon yield curves with a remaining term equal to the expected term of the option. The Company has not historically paid dividends and does not anticipate paying cash dividends in the foreseeable future. The Company used the simplified method to determine expected term.

[Table of Contents](#)

The stock-based compensation expense was recorded as follows (in thousands):

	Year ended December 31,		Six months ended June 30,	
	2015	2016	2016	2017
				(unaudited)
Cost of revenue-software	\$ 44	\$ 22	\$ 14	\$ 16
Research and development	149	1,370	41	3,784
Sales and marketing	109	775	35	2,115
General and administrative	295	2,965	85	8,122
Total stock-based compensation expense	\$ 597	\$ 5,132	\$ 175	\$ 14,037

## 12. Other expense (income), net

Other expense (income), net consists of the following (in thousands):

	Year ended December 31,		Six months ended June 30,	
	2015	2016	2016	2017
				(unaudited)
Foreign exchange (gain) loss	\$ 973	\$(271)	\$ (664)	\$ 917
Other	(191)	(249)	12	(131)
Other expense (income), net	\$ 782	\$(520)	\$ (652)	\$ 786

## 13. Income taxes

The components of income (loss) before income taxes are as follows (in thousands):

	Year ended December 31,	
	2015	2016
U.S.	\$ (6,861)	\$ (2,225)
Non-U.S.	18,610	15,927
	\$11,749	\$13,702

[Table of Contents](#)

The significant components of the income tax expense are as follows (in thousands):

	Year ended	
	December 31,	
	2015	2016
<b>Current</b>		
U.S. Federal	\$ —	\$ —
Non-U.S.	9,893	9,413
U.S. State and Local	56	202
Total current	9,949	9,615
<b>Deferred</b>		
U.S. Federal	(8,445)	(5,358)
Non-U.S.	(587)	(610)
U.S. State and Local	(99)	(108)
Total deferred	(9,131)	(6,076)
Income tax expense	\$ 818	\$ 3,539

The reconciliation of income taxes calculated at the U.S. Federal statutory income tax rate of 35% to income tax expense is as follows (in thousands):

	Year ended	
	December 31,	
	2015	2016
Income taxes at U.S. federal statutory rate	\$ 4,117	\$ 4,796
Foreign income taxes at rates other than the federal statutory rate	(10)	(584)
U.S. state and local income taxes, net of U.S. federal tax benefit	(47)	94
Foreign withholding taxes	3,790	4,235
Foreign dividends	4,152	5,077
U.S. foreign tax credit	(9,808)	(8,786)
Research and development tax credit	(1,608)	(2,696)
Domestic production activities deduction	(833)	(840)
Non-deductible stock-based compensation	234	2,064
Meals & entertainment	258	235
Other	125	(91)
Deferred tax on investment in subsidiary	(214)	(264)
Uncertain tax position	662	299
Income tax expense	\$ 818	\$ 3,539

[Table of Contents](#)

Deferred income tax assets and liabilities result from differences in the basis of assets and liabilities for tax and financial statements purposes. The approximate tax effect of each type of temporary difference, and operating losses and tax credit carryforwards that give rise to a significant portion of the deferred tax assets and liabilities are as follows (in thousands):

	<b>December 31,</b>	
	<b>2015</b>	<b>2016</b>
<b>Deferred tax assets:</b>		
Deferred revenue	\$11,806	\$16,966
Net operating loss carryforwards	2,165	3,550
Tax credit carryforwards	22,878	17,839
Stock-based compensation	15,850	15,825
Capitalized research and development	8,343	12,492
Accrued expenses	1,775	1,775
Employee benefits	2,427	3,995
Other	1,974	2,527
Total deferred tax assets	67,218	74,969
Less: valuation allowance for deferred tax assets	(2,452)	(4,153)
Net deferred tax assets	64,766	70,816
<b>Deferred tax liabilities:</b>		
Prepaid royalties	4,889	5,821
Property and equipment and intangibles	2,619	2,394
Deferred tax on investment in subsidiary	536	272
Other	623	812
Total deferred tax liabilities	8,667	9,299
Net deferred tax assets	\$56,099	\$61,517

Provisions are made for estimated U.S. and non-U.S. income taxes, less available tax credits and deductions, which may be incurred on the remittance of undistributed earnings of foreign subsidiaries not deemed to be indefinitely reinvested. Deferred income taxes have not been provided on the undistributed earnings of certain foreign subsidiaries which are deemed to be indefinitely reinvested of approximately \$3.6 million as of December 31, 2016. There are no other material liabilities for income taxes on the undistributed earnings of foreign subsidiaries as the Company has concluded that such earnings are indefinitely reinvested or should not give rise to additional income tax liabilities as a result of the distribution of such earnings.

The following table summarizes the changes to the valuation allowance balance at December 31, 2016 (In thousands):

Beginning balance	\$ 2,452
Additions charged to expense	177
Deductions	(207)
Other	1,731
Ending balance	\$ 4,153

## [Table of Contents](#)

The following table summarizes the amount and expiration dates of operating loss and tax credit carryforwards at December 31, 2016 (in thousands):

	<b>Expiration dates</b>	<b>Amounts</b>
U.S. general business credits and loss carryforwards	2018-2036	\$ 19,003
Foreign loss carryforwards	indefinite	1,993
U.S. foreign tax credits	2024	393
Total operating loss and tax credit carryforwards		\$ 21,389

A reconciliation of the beginning and ending amounts of unrecognized tax benefits is as follows (in thousands):

	<b>Year ended December 31,</b>	
	<b>2015</b>	<b>2016</b>
Unrecognized tax benefits—January 1	\$ 4,712	\$ 5,305
Increase in unrecognized tax benefits as a result of:		
Additions for tax positions of current period	826	299
Reductions for tax positions of prior periods	(233)	—
Unrecognized tax benefits—December 31	\$ 5,305	\$ 5,604

At December 31, 2016, the Company had \$5.6 million of gross unrecognized tax benefits that if recognized would affect the effective tax rate and adjustments to other tax accounts, primarily deferred taxes. It is reasonably possible that a change in the Company's gross unrecognized tax benefits may occur in the next twelve months; however, it is not possible to reasonably estimate the effect this may have upon the gross unrecognized tax benefits.

The Company operates globally but considers its more significant tax jurisdictions to include the United States, India, Germany, Japan, and China. India has tax years open for examination from 2005 through 2015. All other significant jurisdictions have open tax years from 2013 through 2015.

The Company records interest and penalties with respect to unrecognized tax benefits as a component of the provision for income taxes. For the year ended December 31, 2015, accrued interest and penalties related to unrecognized tax benefits were \$0.1 million and for the year ended December 31, 2016, accrued interest and penalties related to unrecognized tax benefits were insignificant.

At the end of each interim period, the Company makes its best estimate of the annual expected effective income tax rate and applies that rate to its ordinary year-to-date income (loss) before income taxes. The income tax provision or benefit related to unusual or infrequent items, if applicable, that will be separately reported or reported net of their related tax effects are individually computed and recognized in the interim period in which those items occur. In addition, the effect of changes in enacted tax laws or rates, tax status, judgment on the realizability of a beginning-of-the-year deferred tax asset in future years or income tax contingencies is recognized in the interim period in which the change occurs.

The computation of the annual expected effective income tax rate at each interim period requires certain estimates and assumptions including, but not limited to, the expected income (loss) before income taxes for the year, projections of the proportion of income (and/or loss) earned and taxed in respective jurisdictions, permanent and temporary differences, and the likelihood of the realizability of deferred tax assets generated in the current year. Jurisdictions with a projected loss for the year or a year-to-date loss for which no tax benefit or expense can be recognized due to a valuation allowance are excluded from the estimated annual effective tax rate. The impact of such an exclusion could result in a higher or lower effective tax rate during a particular

[Table of Contents](#)

quarter, based upon the composition and timing of actual earnings compared to annual projections. The estimates used to compute the provision or benefit for income taxes may change as new events occur, additional information is obtained or our tax environment changes. To the extent that the expected annual effective income tax rate changes, the effect of the change on prior interim periods is included in the income tax provision in the period in which the change in estimate occurs.

The Company's income tax expense (benefit) and effective tax rate for the six months ended June 30, 2016 and 2017 were as follows (in thousands, except percentages):

	Six months ended June 30,	
	2016	2017 (unaudited)
Income tax expense (benefit)	\$ 2,699	\$ (1,659)
Effective tax rate	41%	15%

The effective tax rate was 41% and 15% for the six months ended June 30, 2016 and 2017, respectively. The tax rate is affected by the Company being a U.S. resident taxpayer, the tax rates in the U.S. and other jurisdictions in which the Company operates, the relative amount of income earned by jurisdiction and the relative amount of losses or income for which no benefit or expense is recognized. The effective tax rate was impacted by the geographic income mix in 2017 as compared to 2016, primarily related to United States pre-tax income of \$7.2 million for 2016 compared to a \$14.9 million pre-tax loss in 2017, and nondeductible stock-based compensation in the amount of \$0.1 million in 2016 compared to \$9.3 million in 2017.

#### 14. Income (loss) per share and unaudited pro forma income (loss) per share

Basic income (loss) per share attributable to common stockholders is computed using the weighted average number of shares of common stock outstanding for the period, excluding stock options. Diluted income (loss) per share attributable to common stockholders is based upon the weighted average number of shares of common stock outstanding for the period and potentially dilutive common shares, including the effect of stock options under the treasury stock method. The following table sets forth the computation of the numerators and denominators used in the basic and diluted income (loss) per share amounts (in thousands, except per share data):

	Year ended December 31,		Six months ended June 30,	
	2015	2016	2016	2017 (unaudited)
<b>Numerator:</b>				
Net income (loss)	\$10,931	\$10,163	\$ 3,953	\$ (9,434)
<b>Denominator:</b>				
Denominator for basic income (loss) per share—weighted average shares	46,609	48,852	47,891	50,255
Effect of dilutive securities, stock options	12,100	9,004	9,345	—
Denominator for dilutive income (loss) per share	58,709	57,856	57,236	50,255
Net income (loss) per share attributable to common stockholders, basic	\$ 0.23	\$ 0.21	\$ 0.08	\$ (0.19)
Net income (loss) per share attributable to common stockholders, diluted	\$ 0.19	\$ 0.18	\$ 0.07	\$ (0.19)

## [Table of Contents](#)

The computation of diluted income (loss) per share does not include shares that are anti-dilutive under the treasury stock method because their exercise prices are higher than the average fair value of the Company's stock during the year. For the year ended December 31, 2015 there were 0.8 million potentially anti-dilutive shares, which were excluded from the computation of income (loss) per share. For the year ended December 31, 2016 there were no anti-dilutive shares excluded from the computation of income (loss) per share. For the six months ended June 30, 2016 and 2017, respectively, there were 0.8 million and 9.6 million anti-dilutive shares excluded from the computation of income (loss) per share.

### *Unaudited pro forma income (loss) per share*

The unaudited pro forma income (loss) per share has been computed to give effect to the assumed automatic conversion of the class A redeemable common shares into shares of Class A common stock that will occur upon effectiveness of the initial public offering, as though the conversion had occurred as of the beginning of the period, and to reduce expense for the change in fair value for the class A redeemable common shares which was recorded during those related periods.

The following table sets forth the computation of the Company's unaudited pro forma numerators and denominators used in the pro forma basic and diluted income (loss) per share amounts (in thousands, except per share data):

	<u>Year ended December 31,</u> <u>2016</u>	<u>Six months ended June 30,</u> <u>2017</u> (unaudited)
Numerator:		
Net income (loss)	\$ 10,163	\$ (9,434)
Pro forma adjustment to reflect the effect of stock-based redeemable class A common shares	2,178	6,131
Pro forma net income (loss)	<u>\$ 12,341</u>	<u>\$ (3,303)</u>
Denominator:		
Denominator for basic income (loss) per share—weighted average shares	48,852	50,255
Effect of dilutive securities, stock options	9,004	—
Denominator for dilutive income (loss) per share	<u>57,856</u>	<u>50,255</u>
Pro forma net income (loss) per share attributable to common stockholders, basic	<u>\$ 0.25</u>	<u>\$ (0.07)</u>
Pro forma net income (loss) per share attributable to common stockholders, diluted	<u>\$ 0.21</u>	<u>\$ (0.07)</u>

## **15. Retirement benefits**

The Company sponsors a 401(k) profit sharing plan (the "Plan") for all eligible U.S. employees. This Plan allows eligible employees to contribute up to 80% of their compensation to the Plan. The Company makes discretionary matching contributions to the Plan provided the employee is employed on the last day of the year. Such discretionary contributions vest ratably over five years of service. The Company's contributions to the Plan were \$0.9 million and \$1.1 million for the years ended December 31, 2015 and 2016, respectively.

The Company also participates in government-mandated retirement and/or termination indemnity plans, benefiting certain non-U.S. employees. Termination benefits are generally lump sum payments based upon an



[Table of Contents](#)

individual's years of credited service and annual salary at retirement. These plans are generally unfunded and employees receive payments at the time of retirement or termination under applicable labor laws or agreements. The amount of net benefit cost recorded in the consolidated statements of operations for these plans was \$0.6 million and \$0.9 million in 2015 and 2016, respectively. The amount of benefits paid under these plans was \$0.1 million and \$0.2 million in 2015 and 2016, respectively. The accumulated benefit obligation, unlike the projected benefit obligation, does not reflect expected benefit increases from future salary levels, and was \$1.7 million and \$3.0 million at December 31, 2015 and 2016, respectively, under these plans. The liability for pension benefits representing the projected benefit obligation, net of plan assets of \$0.4 million and \$0.7 million, under these plans was \$4.7 million and \$6.3 million at December 31, 2015 and 2016, respectively. A summary of the components of the pension benefits obligation recorded in the consolidated balance sheets are as follows (in thousands):

	<b>December 31,</b>	
	<b>2015</b>	<b>2016</b>
Accrued compensation and benefits	\$ 265	\$ 332
Other long-term liabilities	4,436	5,959
	<b>\$4,701</b>	<b>\$6,291</b>

The estimated future benefit payments, which reflect expected future service, that are expected to be paid for each of the next five years (in thousands):

<b>Year ending</b>	
December 31, 2017	\$ 356
December 31, 2018	\$ 193
December 31, 2019	\$ 261
December 31, 2020	\$ 299
December 31, 2021	\$ 185
Next five years	\$1,535

## 16. Accumulated other comprehensive loss

The components of accumulated other comprehensive loss is as follows (in thousands):

	Foreign currency translation	Retirement related benefit plans	Total
Balance at December 31, 2014	\$ (3,631)	\$ (710)	\$(4,341)
Other comprehensive loss before reclassification	(3,068)	(217)	(3,285)
Tax effects	953	(36)	917
Other comprehensive loss	(2,115)	(253)	(2,368)
Less: Other comprehensive income (loss) attributable to noncontrolling interest	(1)	—	(1)
Balance at December 31, 2015	(5,745)	(963)	(6,708)
Other comprehensive loss before reclassification	80	(771)	(691)
Tax effects	(60)	195	135
Other comprehensive income (loss)	20	(576)	(556)
Less: Other comprehensive income (loss) attributable to noncontrolling interest	—	—	—
Balance at December 31, 2016	(5,725)	(1,539)	(7,264)
Other comprehensive income (loss) before reclassification (unaudited)	1,511	(134)	1,377
Amounts reclassified from accumulated other comprehensive loss (unaudited)	—	90	90
Tax effects (unaudited)	—	—	—
Other comprehensive income (loss) (unaudited)	1,511	(44)	1,467
Balance at June 30, 2017 (unaudited)	\$ (4,214)	\$ (1,583)	\$(5,797)

## 17. Related party transactions

In February 2017, the Company purchased the noncontrolling interest in a consolidated subsidiary from a founder stockholder for an aggregate purchase price of \$29 thousand (unaudited).

In January 2016, the Company redeemed 350,400 shares of old Class B Non-Voting Common Stock from founder stockholders for an aggregate purchase price of \$1.3 million payable in twelve equal monthly installments.

In June 2016, the Company redeemed 137,268 shares of old Class B Non-Voting Common Stock from a related party for an aggregate purchase price of \$0.5 million payable in two equal installments.

In December 2016, the Company redeemed 59,108 shares of old Class B Non-Voting Common Stock from a related party for an aggregate purchase price of \$0.3 million payable in twelve equal monthly installments.

In December 2016, the Company redeemed 113,388 shares of old Class A Voting Common Stock from a founder stockholder for an aggregate purchase price of \$0.6 million payable in nine equal monthly installments.

In October 2015, the Company acquired Altair Bellingham, LLC from significant stockholders of the Company for cash of \$0.7 million, which was paid in February 2016.

In 2015, the Company redeemed 200,000 shares of old Class B Non-Voting Common Stock for an aggregate purchase price of \$0.7 million payable in equal monthly installments of principal and interest over three years.

## [Table of Contents](#)

At December 31, 2015 and 2016, and June 30, 2017, respectively, the Company had obligations to related parties for the redemptions summarized above in the amounts of \$1.3 million, \$1.0 million and \$0.5 million (unaudited) recorded in other accrued expenses and current liabilities, and \$0.4 million, \$0.1 million and \$0.0 million (unaudited) recorded in other long-term liabilities.

At December 31, 2015 and 2016, and June 30, 2017, respectively, the Company had receivables from an equity investment for \$0.2 million, \$0.4 million and \$0.5 million (unaudited) recorded in other long-term assets.

## **18. Commitments and contingencies**

### ***MSC Litigation***

In July 2007, MSC Software Corporation filed a lawsuit against the Company alleging misappropriation of trade secrets, breach of confidentiality and other claims. On April 10, 2014, a jury returned a verdict against the Company. The Company challenged the verdict and on November 13, 2014, a judge vacated all but \$0.4 million of the judgment and ordered a new trial on damages. The Company has estimated and recorded a liability for the probable loss.

### ***Legal proceedings***

From time to time, the Company may be subject to legal proceedings and claims in the ordinary course of business. The Company has received, and may in the future continue to receive, claims from third parties asserting, among other things, infringement of their intellectual property rights. Future litigation may be necessary to defend the Company, its partners and its customers by determining the scope, enforceability and validity of third party proprietary rights, or to establish and enforce the Company's proprietary rights. The results of any current or future litigation cannot be predicted with certainty and regardless of the outcome, litigation can have an adverse impact on the Company because of defense and settlement costs, diversion of management resources and other factors.

### ***Royalty agreements***

The Company has entered into various renewable, nonexclusive license agreements under which the Company has been granted access to the licensor's technology and the right to sell or use the technology in the Company's products. Royalties are payable to developers of the software at various rates and amounts, which generally are based upon unit sales or revenue. Royalty fees were \$7.1 million, and \$7.9 million for the years ended December 31, 2015 and 2016, respectively, and are reported in Cost of revenue-software.

### ***Leases***

The Company leases office space, vehicles, and computer equipment. Such leases, some of which are noncancelable, are set to expire at various dates. Certain of these lease arrangements contain escalation clauses whereby monthly rent increases over time.

## [Table of Contents](#)

The future minimum annual lease payments under noncancelable operating leases with an initial term in excess of one year and future minimum capital lease payments at December 31, 2016 are as follows (in thousands):

	Capital leases	Operating leases
<b>Year Ending December 31,</b>		
2017	\$ 131	\$ 7,362
2018	65	4,801
2019	—	3,309
2020	—	1,879
2021	—	1,159
Thereafter	—	21
Total minimum lease payments	196	\$ 18,531
Less: current installments under capital lease obligations	131	
Total long-term portion	\$ 65	

Rent expense for operating leases was \$7.7 million and \$8.5 million for the years ended December 31, 2015 and 2016, respectively.

## 19. Segment information

The Company defines its operating segments as components of its business where separate financial information is available and used by the chief operating decision maker (“CODM”) in deciding how to allocate resources to its segments and in assessing performance. The Company’s CODM is its Chief Executive Officer.

The Company has identified two reportable segments for financial reporting purposes: Software and Client Engineering Services. The primary measure of segment operating performance is Adjusted EBITDA, which is defined as net income (loss) adjusted for income tax expense (benefit), interest expense, interest income and other, depreciation and amortization, stock-based compensation expense, restructuring charges, asset impairment charges and other special items as determined by management. Adjusted EBITDA includes an allocation of corporate headquarters costs.

The Software reportable segment derives revenue from the sale and lease of licenses for software products focused on the development and application of simulation technology to synthesize and optimize designs, processes and decisions for improved business performance. The Software segment also derives revenue from software support, upgrades, training and consulting services focused on product design and development expertise and analysis support from the component level up to complete product engineering at any stage of the lifecycle.

The Client Engineering Services reportable segment provides support to its customers with long-term ongoing product design and development expertise in its market segments of Solvers & Optimization, Modeling & Visualization, Industrial and Concept Design, and high-performance computing. The Company hires simulation specialists, industrial designers, design engineers, materials experts, development and test specialists, manufacturing engineers and information technology specialists for placement at customer sites for specific customer-directed assignments.

The “All other” represents innovative services and products, including toggled®, the Company’s LED lighting and IoT business. toggled® is focused on developing and selling next-generation solid state lighting technology along with communication and control protocols based on intellectual property for the direct replacement of

[Table of Contents](#)

fluorescent light tubes with LED lamps. Potential services and product concepts that are still in their development stages are also included in "All other."

Inter-segment sales are not significant for any period presented. The CODM does not review asset information by segment when assessing performance, therefore no asset information is provided for reportable segments. The accounting policies of the segments are the same as those described in Note 2—Summary of significant accounting policies. The following tables are in thousands:

		Client engineering services	All other	Total
<b>Year ended December 31, 2015</b>	<b>Software</b>			
Revenue	\$242,861	\$ 45,075	\$ 6,193	\$294,129
Adjusted EBITDA	\$ 23,149	\$ 4,776	\$(4,976)	\$ 22,949

		Client engineering services	All other	Total
<b>Year ended December 31, 2016</b>	<b>Software</b>			
Revenue	\$259,588	\$ 47,702	\$ 5,950	\$313,240
Adjusted EBITDA	\$ 29,411	\$ 5,425	\$(4,006)	\$ 30,830

		Client engineering services	All other	Total
<b>Six months ended June 30, 2016</b>	<b>Software</b>			
Revenue (unaudited)	\$124,719	\$ 24,289	\$ 3,332	\$152,340
Adjusted EBITDA (unaudited)	\$ 11,798	\$ 2,914	\$ (1,779)	\$ 12,933

		Client engineering services	All other	Total
<b>Six months ended June 30, 2017</b>	<b>Software</b>			
Revenue (unaudited)	\$130,872	\$ 24,594	\$ 3,062	\$158,528
Adjusted EBITDA (unaudited)	\$ 6,723	\$ 2,742	\$(2,409)	\$ 7,056

	Year ended December 31,		Six months ended June 30,	
	2015	2016	2016	2017
				(unaudited)

<b>Reconciliation of Adjusted EBITDA to U.S. GAAP Income (loss) before income taxes:</b>				
Adjusted EBITDA	\$22,949	\$30,830	\$12,933	\$ 7,056
Stock-based compensation expense	(597)	(5,132)	(175)	(14,037)
Interest expense	(2,416)	(2,265)	(1,247)	(1,159)
Interest income and other <sup>(1)</sup>	191	249	(12)	2,131
Depreciation and amortization	(8,378)	(9,980)	(4,847)	(5,084)
<b>Income (loss) before income taxes</b>	<b>\$11,749</b>	<b>\$13,702</b>	<b>\$ 6,652</b>	<b>\$(11,093)</b>

(1) Includes a non-recurring adjustment for a change in estimated legal expenses resulting in \$2 million of income for the six months ended June 30, 2017.

## [Table of Contents](#)

Revenue is attributed to geographic areas based on the country of origin. The following table provides sales to external customers and long-lived assets for each of the geographic areas in which the Company operates (in thousands):

	Revenue		December 31, 2016	
			Long-lived assets <sup>(1)</sup>	
	2015	2016	2015	2016
United States	\$130,791	\$139,079	\$22,301	\$25,901
Other countries	4,841	6,032	95	120
<b>Total Americas</b>	<b>135,632</b>	<b>145,111</b>	<b>22,396</b>	<b>26,021</b>
Germany	37,549	39,470	1,871	2,660
France	14,057	15,729	572	2,175
Other countries	35,933	34,909	4,619	4,317
<b>Total Europe, Middle East and Africa</b>	<b>87,539</b>	<b>90,108</b>	<b>7,062</b>	<b>9,152</b>
Japan	26,795	33,198	976	879
Other countries	44,163	44,823	3,038	2,999
<b>Total Asia Pacific</b>	<b>70,958</b>	<b>78,021</b>	<b>4,014</b>	<b>3,878</b>
<b>Total</b>	<b>\$294,129</b>	<b>\$313,240</b>	<b>\$33,472</b>	<b>\$39,051</b>

(1) Includes property and equipment, net and definite-lived intangible assets, net.

## 20. Subsequent events

For its consolidated financial statements as of December 31, 2016 and 2015, and for each of the two years in the period ended December 31, 2016, the Company has evaluated all events occurring through June 16, 2017, the date the consolidated financial statements were available for issuance.

## 21. Subsequent events (unaudited)

### Runtime Design Automation

On September 28, 2017, the Company acquired Runtime Design Automation (“Runtime”) for \$10.0 million cash, an \$8.7 million deferred payment obligation, and 708,000 shares of the Company’s Class A voting common stock. Runtime complements Altair’s PBS Works™ suite of products for comprehensive, secure workload management for HPC and cloud environments and has solutions to manage highly complex workflows. PBS Works targets product design, weather prediction, oil exploration and bio-informatics, and Runtime primarily serves customers in electronic design automation.

The Company has evaluated subsequent events through August 25, 2017, the date the unaudited interim consolidated financial statements were available to be issued, except for the first paragraph of this note as to which the date is September 29, 2017.

*shares*

ALTAIR ENGINEERING INC.

*Class A common stock*



**J.P. Morgan**

**RBC Capital Markets**

**Deutsche Bank Securities**

**William Blair**

**Canaccord Genuity**

Until \_\_\_\_\_, 2017 (the 25th day after the commencement of this offering), all dealers that effect transactions in these securities, whether or not participating in this offering, may be required to deliver a prospectus. This is in addition to the dealers' obligation to deliver a prospectus when acting as an underwriter and with respect to their unsold allotments or subscriptions.

## Part II

### Information not required in the prospectus

#### Item 13. Other expenses of issuance and distribution.

The following table sets forth all fees and expenses to be paid by us, other than estimated underwriting discounts and commissions, in connection with this offering. All amounts shown are estimates except for the registration fee, the FINRA filing fee and the exchange listing fee.

	<b>Amount to be paid</b>
SEC registration fee	*
FINRA filing fee	*
Securities exchange fee	*
Printing and engraving expenses	*
Legal fees and expenses	*
Accounting fees and expenses	*
Blue Sky fees and expenses (including legal fees)	*
Transfer agent and registrar fees and expenses	*
Miscellaneous	*
Total	\$ *

\* To be filed by amendment.

#### Item 14. Indemnification of directors and officers.

Section 145 of the Delaware General Corporation Law, or DGCL, authorizes a corporation's board of directors to grant, and authorizes a court to award, indemnity to officers, directors, and other corporate agents under certain circumstances and subject to certain limitations. The terms of Section 145 of the DGCL are sufficiently broad to permit indemnification under certain circumstances for liabilities, including reimbursement of expenses incurred, arising under the Securities Act of 1933, as amended, or the Securities Act.

As permitted by the DGCL, our certificate of incorporation and bylaws include provisions that eliminate the personal liability of its directors and officers for monetary damages for breach of their fiduciary duty as directors and officers.

In addition, as permitted by Section 145 of the DGCL, our certificate of incorporation and bylaws provide that:

- we shall indemnify our directors and officers for serving us in those capacities or for serving other business enterprises at our request, to the fullest extent permitted by Delaware law. Delaware law provides that a corporation may indemnify such person if such person acted in good faith and in a manner such person reasonably believed to be in or not opposed to the best interests of the corporation and, with respect to any criminal proceeding, had no reasonable cause to believe such person's conduct was unlawful;
- we may, in our discretion, indemnify employees and agents in those circumstances where indemnification is permitted by applicable law;
- we are required to advance expenses, as incurred, to our directors and officers in connection with defending a proceeding, except that such director or officer shall undertake to repay such advances if it is ultimately determined that such person is not entitled to indemnification;



## [Table of Contents](#)

- we will not be obligated pursuant to our Delaware bylaws to indemnify a person with respect to proceedings initiated by that person, except with respect to proceedings authorized by our board of directors or brought to enforce a right to indemnification;
- the rights conferred in our certificate of incorporation and bylaws are not exclusive, and we are authorized to enter into indemnification agreements with our directors, officers, employees, and agents and to obtain insurance to indemnify such persons; and
- we may not retroactively amend the bylaw provisions to reduce our indemnification obligations to directors, officers, employees, and agents.

Our policy is to enter into separate indemnification agreements with each of our directors and certain officers that provide the maximum indemnity allowed to directors and executive officers by Section 145 of the DGCL and also to provide for certain additional procedural protections. We also maintain directors and officers insurance to insure such persons against certain liabilities.

These indemnification provisions and the indemnification agreements to be entered into between us and our directors and officers may be sufficiently broad to permit indemnification of our officers and directors for liabilities (including reimbursement of expenses incurred) arising under the Securities Act.

The Underwriting Agreement to be filed as Exhibit 1.1 to this registration statement provides for indemnification by the underwriters of us, our executive officers and directors and the selling stockholders, and by us and the selling stockholders of the underwriters for certain liabilities, including liabilities arising under the Securities Act and otherwise.

We have purchased and intend to maintain insurance on behalf of any person who is or was a director or officer against any loss arising from any claim asserted against him or her and incurred by him or her in any such capacity, subject to certain exclusions. Prior to the completion of this offering, we may procure additional insurance to provide coverage to our directors and officers against loss arising from claims relating to, among other things, public securities matters.

See also the undertakings set out in response to Item 17 herein.

### **Item 15. Recent sales of unregistered securities.**

Set forth below is information regarding shares of our capital stock issued by us within the past three years, giving effect to a four-for-one stock split of our common stock that occurred on October 5, 2017 in connection with becoming a Delaware corporation. Also included is the consideration received by us for such shares and information relating to the section of the Securities Act, or rule of the SEC, under which exemption from registration was claimed.

#### ***Plan-related issuances***

- (1) From September 25, 2014 through September 25, 2017, we granted to our directors, officers, employees, consultants and other service providers options to purchase an aggregate of 1,468,668 shares of our old Class B Common Stock with per share exercise prices ranging from \$3.56 to \$5.18 under our 2012 Stock Plan.
- (2) From September 25, 2014 through September 25, 2017, we issued to our directors, officers, employees, consultants and other service providers an aggregate of 342,472 shares of our old Class B Common Stock with per share exercise prices ranging from \$2.48 to \$4.52 pursuant to exercises of options granted under our 2012 Stock Plan.
- (3) From September 25, 2014 through September 25, 2017, we issued to our directors, officers, employees, consultants and other service providers an aggregate of 4,179,484 shares of our old Class B Common Stock with a per share exercise price of \$0.000025 pursuant to exercises of options granted under our 2001 Nonqualified Stock Option Plan.

## Table of Contents

- (4) From September 25, 2014 through September 25, 2017, we issued to our directors, officers, employees, consultants and other service providers an aggregate of 946,468 shares of our old Class B Common Stock with per share exercise prices ranging from \$0.23 to \$1.29 pursuant to exercises of options granted under our 2001 Incentive and Nonqualified Stock-based Plan.

The issuances and grants of the securities described in Items 1 through 4 were exempt from registration under the Securities Act under Rule 701 in that the transactions were made pursuant to compensatory benefit plans and contractors relating to compensation as provided under Rule 701. The recipients of such securities were our employees, consultants or directors. The recipients of securities in each of these transactions represented their intention to acquire the securities for investment only and not with view to or for sale in connection with any distribution thereof and appropriate legends were affixed to the securities issued in these transactions.

### **Shares issued in connection with acquisitions**

- (1) On May 31, 2014, we issued an aggregate of 659,364 shares of our old Class A common stock to the stockholders of EM Software & Systems GmbH and EM Software & Systems (USA) Inc., or the EMSS Entities, as partial consideration for our acquisition of all of the outstanding equity of the EMSS Entities pursuant to the terms of the agreement for stock subscription, purchase and sale and related transactions under which we acquired the EMSS Entities.
- (2) In connection with our acquisition of the EMSS Entities, on May 31, 2014, we issued 14,000 shares of our old Class A Common Stock to an EMSS-affiliated purchaser for an aggregate purchase price of \$55,230.
- (3) From September 10, 2014 to October 14, 2014, we issued an aggregate of 126,636 shares of our old Class A Common Stock to certain EMSS-affiliated purchasers for an aggregate purchase price of \$499,579.02, in connection with the acquisition of the EMSS Entities.
- (4) On August 15, 2014, we issued an aggregate of 160,000 shares of our old Class A Common Stock to the stockholders of Visual Solutions, Inc., or VSI, as partial consideration for our acquisition of all of the outstanding equity of VSI pursuant to the terms of the stock purchase agreement under which we acquired VSI.
- (5) On March 12, 2015, we issued 200,000 shares of our old Class A Common Stock to the sole stockholder of Multiscale Design Systems, LLC, or MDS, as partial consideration for our acquisition of all of the outstanding equity of MDS pursuant to the terms of the membership interest purchase agreement under which we acquired MDS.
- (6) On May 5, 2017, we issued 80,000 shares of our Class A Common Stock to the shareholders of Carriots, S.L, or Carriots, as partial consideration for our acquisition of all of the outstanding equity of Carriots pursuant to the terms of the share purchase agreement under which we acquired Carriots.
- (7) On May 5, 2017, we issued 200,000 shares of our Class A Common Stock to Easii IC SAS, or Easii, as partial consideration for its assignment of all of its rights to some of its software pursuant to the terms of the software assignment agreement under which we acquired the software.
- (8) On September 28, 2017, we issued 708,000 shares of our Class A Common Stock to shareholders of Runtime Design Automation, or Runtime, as partial consideration for the consummation of the merger of our wholly-owned subsidiary, RTDA Acquisition Corporation, into Runtime pursuant to the terms of the agreement and plan of merger under which we acquired Runtime.

The issuances of the securities described in Items 1 through 8 above were exempt from registration under the Securities Act pursuant to Section 4(a)(2) of the Securities Act. We relied on the written representation of the recipients of the shares as to their statuses as "accredited investors" as defined in Rule 501(a) of Regulation D in the issuances described in items 1 through 8 above. In addition, we relied on an exemption under Rule 506(b) of Regulation D in the issuance described in item 8 above.

## [Table of Contents](#)

None of the foregoing transactions involved any underwriters, underwriting discounts or commissions, or any public offering. We believe these transactions were exempt from registration under the Securities Act in reliance upon Section 4(a)(2) of the Securities Act (or Regulation D or Regulation S promulgated thereunder), or Rule 701 promulgated under Section 3(b) of the Securities Act as transactions by an issuer not involving any public offering or pursuant to benefit plans and contracts relating to compensation as provided under Rule 701. The recipients of the securities in each of these transactions represented their intentions to acquire the securities for investment only and not with a view to or for sale in connection with any distribution thereof, and appropriate legends were placed upon the stock certificates issued in these transactions. All recipients had adequate access, through their relationships with us, to information about us. The sales of these securities were made without any general solicitation or advertising.

### **Item 16. Exhibits and financial statement schedules.**

#### **(a) Exhibits:**

The exhibit index attached hereto is incorporated herein by reference.

#### **(b) Financial statement schedules.**

All schedules have been omitted because the information required to be set forth therein is not applicable or is shown in the financial statements or notes thereto.

### **Item 17. Undertakings.**

(a) The undersigned Registrant hereby undertakes to provide to the underwriters at the closing specified in the underwriting agreement certificates in such denominations and registered in such names as required by the underwriters to permit prompt delivery to each purchaser.

(b) Insofar as indemnification for liabilities arising under the Securities Act of 1933 may be permitted to directors, officers and controlling persons of the Registrant pursuant to the foregoing provisions, or otherwise, the Registrant has been advised that in the opinion of the SEC such indemnification is against public policy as expressed in the Act and is, therefore, unenforceable. In the event that a claim for indemnification against such liabilities (other than the payment by the Registrant of expenses incurred or paid by a director, officer or controlling person of the Registrant in the successful defense of any action, suit or proceeding) is asserted by such director, officer or controlling person in connection with the securities being registered, the Registrant will, unless in the opinion of its counsel the matter has been settled by controlling precedent, submit to a court of appropriate jurisdiction the question whether such indemnification by it is against public policy as expressed in the Act and will be governed by the final adjudication of such issue.

(c) The undersigned Registrant hereby undertakes that:

- (1) For purposes of determining any liability under the Securities Act of 1933, the information omitted from the form of prospectus filed as part of this registration statement in reliance upon Rule 430A and contained in a form of prospectus filed by the Registrant pursuant to Rule 424(b)(1) or (4) or 497(h) under the Securities Act shall be deemed to be part of this registration statement as of the time it was declared effective.
- (2) For the purpose of determining any liability under the Securities Act of 1933, each post-effective amendment that contains a form of prospectus shall be deemed to be a new registration statement relating to the securities offered therein, and the offering of such securities at that time shall be deemed to be the initial bona fide offering thereof.

## Exhibit index

Exhibit No.	Description
1.1	<a href="#">Form of Underwriting Agreement</a>
3.1	<a href="#">Certificate of Incorporation</a> , as currently in effect
3.2	<a href="#">Bylaws, as currently in effect</a>
4.1**	Specimen Stock Certificate of the Registrant
5.1**	Form of Opinion of Lowenstein Sandler LLP
10.1*	<a href="#">Form of Indemnification Agreement between the Registrant and each of its directors and executive officers</a>
10.2+*	<a href="#">2001 Incentive and Non-Qualified Stock Option Plan</a>
10.3+*	<a href="#">Form of 2001 Incentive and Non-Qualified Stock Option Plan Incentive Stock Option Agreement</a>
10.4+*	<a href="#">Form of 2001 Incentive and Non-Qualified Stock Option Plan Stock Restriction and Repurchase Agreement</a>
10.5+*	<a href="#">2001 Non-Qualified Stock Option Plan</a>
10.6+*	<a href="#">Form of 2001 Non-Qualified Stock Option Plan Non-Qualified Stock Option Agreement</a>
10.7+*	<a href="#">Form of 2001 Non-Qualified Stock Option Plan Stock Restriction Agreement</a>
10.8+*	<a href="#">2012 Incentive and Non-Qualified Stock Option Plan</a>
10.9+*	<a href="#">Form of 2012 Incentive and Non-Qualified Stock Option Plan Option Agreement</a>
10.10+*	<a href="#">Form of 2012 Incentive and Non-Qualified Stock Option Plan Stock Restriction and Repurchase Agreement</a>
10.11+*	<a href="#">Form of 2012 Incentive and Non-Qualified Stock Option Plan Stock Restriction and Repurchase Agreement (Directors)</a>
10.12+	<a href="#">2017 Equity Incentive Plan and forms of equity agreements thereunder</a>
10.13+*	<a href="#">Employment Letter, dated January 10, 2013, by and between the Registrant and Howard N. Morof as amended on July 19, 2017</a>
10.14*	<a href="#">2017 Second Amended and Restated Credit Agreement, dated June 14, 2017, by and among the Registrant, the foreign subsidiary borrowers, the Lenders named therein and JP Morgan Chase Bank, N.A. as administrative agent, as last amended September 28, 2017</a>
10.15+*	<a href="#">Consulting Agreement, effective as of January 1, 2017, by and between the Registrant and Advanced Studies Holding Future SRL, an Italian Company, as amended</a>
21.1	<a href="#">List of Subsidiaries of the Registrant</a>
23.1	<a href="#">Consent of Independent Registered Public Accounting Firm</a>
23.2**	Consent of Lowenstein Sandler LLP (contained in Exhibit 5.1)
24.1*	<a href="#">Power of Attorney</a>

\* Previously filed.

+ Indicates management contract or compensatory plan.

\*\* To be filed by amendment.



## ALTAIR ENGINEERING INC.

\_\_\_\_\_ Shares of Class A Common Stock, par value \$0.0001 per share

## Underwriting Agreement

\_\_\_\_\_, 2017

J. P. Morgan Securities LLC  
RBC Capital Markets, LLC

As Representatives of the  
several Underwriters listed  
in Schedule 1 hereto

c/o J. P. Morgan Securities LLC  
383 Madison Avenue  
New York, New York 10179

c/o RBC Capital Markets, LLC  
Three World Financial Center  
200 Vesey Street  
New York, NY 10281

Ladies and Gentlemen:

Altair Engineering Inc., a Delaware corporation (the "Company"), proposes to issue and sell to the several underwriters listed in Schedule 1 hereto (the "Underwriters"), for whom you are acting as representatives (the "Representatives"), an aggregate of \_\_\_\_\_ shares of Class A Common Stock, par value \$0.0001 per share, of the Company ("Class A Common Stock"), and certain stockholders of the Company named in Schedule 2 hereto (the "Selling Stockholders"), severally and not jointly, propose to sell to the several Underwriters an aggregate of \_\_\_\_\_ shares of Class A Common Stock (collectively, the "Underwritten Shares"). In addition, the Company proposes to issue and sell, at the option of the Underwriters, up to an additional \_\_\_\_\_ shares of Class A Common Stock of the Company, (the "Option Shares"). The Underwritten Shares and the Option Shares are herein referred to as the "Shares". The shares of Class B Common Stock, par value \$0.0001 per share, of the Company are hereinafter referred to as the "Class B Common Stock". The shares of Class A Common Stock and Class B Common Stock to be outstanding after giving effect to the sale of the Shares are referred to herein as the "Stock".

The Company and the Selling Stockholders hereby confirm their agreement with the several Underwriters concerning the purchase and sale of the Shares, as follows:

1. Registration Statement. The Company has prepared and filed with the Securities and Exchange Commission (the "Commission") under the Securities Act of 1933, as amended, and the rules and regulations of the Commission thereunder (collectively, the "Securities Act"), a registration statement on Form S-1 (File No. 333-220710), including a prospectus, relating to the Shares. Such registration statement, as amended at the time it became effective, including the information, if any, deemed pursuant

to Rule 430A, 430B or 430C under the Securities Act to be part of the registration statement at the time of its effectiveness (“Rule 430 Information”), is referred to herein as the “Registration Statement”; and as used herein, the term “Preliminary Prospectus” means each prospectus included in such registration statement (and any amendments thereto) before effectiveness, any prospectus filed with the Commission pursuant to Rule 424(a) under the Securities Act and the prospectus included in the Registration Statement at the time of its effectiveness that omits Rule 430 Information, and the term “Prospectus” means the prospectus in the form first used (or made available upon request of purchasers pursuant to Rule 173 under the Securities Act) in connection with confirmation of sales of the Shares. If the Company has filed an abbreviated registration statement pursuant to Rule 462(b) under the Securities Act (the “Rule 462 Registration Statement”), then any reference herein to the term “Registration Statement” shall be deemed to include such Rule 462 Registration Statement. Capitalized terms used but not defined herein shall have the meanings given to such terms in the Registration Statement and the Prospectus.

At or prior to the Applicable Time (as defined below), the Company had prepared the following information (collectively with the pricing information set forth on Annex A, the “Pricing Disclosure Package”): a Preliminary Prospectus dated [ • ], 2017 and each “free-writing prospectus” (as defined pursuant to Rule 405 under the Securities Act) listed on Annex A hereto.

“Applicable Time” means [ • ] [A/P].M., New York City time, on [ • ], 2017.

## 2. Purchase of the Shares.

(a) On the basis of the respective Company and Selling Stockholder representations, warranties and agreements set forth herein and subject to the conditions set forth herein, the Company agrees to issue and sell, and each of the Selling Stockholders agrees, severally and not jointly, to sell, the respective Underwritten Shares to the several Underwriters as provided in this underwriting agreement (this “Agreement”), and each Underwriter agrees, severally and not jointly, to purchase at a price per share (the “Purchase Price”) of \$[•] (i) from the Company the respective number of Underwritten Shares set forth opposite such Underwriter’s name in Schedule 1 hereto and (ii) from each of the Selling Stockholders the number of Underwritten Shares (to be adjusted by you so as to eliminate fractional shares) determined by multiplying the aggregate number of Underwritten Shares to be sold by each of the Selling Stockholders as set forth opposite their respective names in Schedule 2 hereto by a fraction, the numerator of which is the aggregate number of Underwritten Shares to be purchased by such Underwriter as set forth opposite the name of such Underwriter in Schedule 1 hereto and the denominator of which is the aggregate number of Underwritten Shares to be purchased by all the Underwriters from all of the Selling Stockholders hereunder. The public offering price of the Shares is not in excess of the price recommended by Deutsche Bank Securities, Inc., acting as a “qualified independent underwriter” within the meaning of Rule 5121 of the Financial Industry Regulatory Authority, Inc. (“FINRA”).

In addition, on the basis of the respective Company and Selling Stockholder representations, warranties and agreements set forth herein and subject to the conditions set forth herein, the Company agrees to issue and sell the Option Shares to the several Underwriters as provided in this Agreement, and the Underwriters shall have the option to purchase the Option Shares from the Company as provided in this Agreement, at the Purchase Price.

If any Option Shares are to be purchased, the number of Option Shares to be purchased by each Underwriter shall be the number of Option Shares which bears the same ratio to the aggregate number of Option Shares being purchased as the number of Underwritten Shares set forth opposite the name of such Underwriter in Schedule 1 hereto (or such number increased as set forth in Section 13 hereof) bears to the aggregate number of Underwritten Shares being purchased from the Company by the several Underwriters, subject, however, to such adjustments to eliminate any fractional Shares as the Representatives in their sole discretion shall make. Any such election to purchase Option Shares shall be made in proportion to the maximum number of Option Shares to be sold by the Company as set forth in Schedule 2 hereto.

The Underwriters may exercise the option to purchase Option Shares at any time in whole, or from time to time in part, on or before the thirtieth day following the date of the Prospectus, by written notice from the Representatives to the Company. Such notice shall set forth the aggregate number of Option Shares as to which the option is being exercised and the date and time when the Option Shares are to be delivered and paid for, which may be the same date and time as the Closing Date (as hereinafter defined) but shall not be earlier than the Closing Date nor later than the tenth full business day (as hereinafter defined) after the date of such notice (unless such time and date are postponed in accordance with the provisions of Section 13 hereof). Any such notice shall be given at least two business days prior to the date and time of delivery specified therein.

(b) The Company and the Selling Stockholders understand that the Underwriters intend to make a public offering of the Shares as soon after the effectiveness of this Agreement as in the judgment of the Representatives is advisable, and initially to offer the Shares on the terms set forth in the Pricing Disclosure Package. The Company and the Selling Stockholders acknowledge and agree that the Underwriters may offer and sell Shares to or through any affiliate of an Underwriter.

(c) Payment for the Shares shall be made by wire transfer in immediately available funds to the accounts specified by the Company and the Attorneys-in-Fact or any of them (as defined below) (with regard to payment to the Selling Stockholders) to the Representatives in the case of the Underwritten Shares, at the offices of Goodwin Procter LLP, 620 Eighth Avenue, New York, New York 10018 at 10:00 A.M., New York City time, on [●], 2017, or at such other time or place on the same or such other date, not later than the fifth business day thereafter, as the Representatives, the Company and the Attorneys-in-Fact may agree upon in writing or, in the case of the Option Shares, on the date and at the time and place specified by the Representatives in the written notice of the Underwriters' election to purchase such Option Shares. The time and date of such payment for the Underwritten Shares is referred to herein as the "Closing Date", and the time and date for such payment for the Option Shares, if other than the Closing Date, is herein referred to as the "Additional Closing Date".

Payment for the Shares to be purchased on the Closing Date or the Additional Closing Date, as the case may be, shall be made against delivery to the Representatives for the respective accounts of the several Underwriters of the Shares to be purchased on such date or the Additional Closing Date, as the case may be, with any transfer taxes payable in connection with the sale of such Shares duly paid by the Company and the Selling Stockholders, as applicable. Delivery of the Shares shall be made through the facilities of The Depository Trust Company ("DTC") unless the Representatives shall otherwise instruct. The certificates for the Shares will be made available for inspection and packaging by the Representatives at the office of DTC or its designated custodian not later than 1:00 P.M., New York City time, on the business day prior to the Closing Date or the Additional Closing Date, as the case may be.

(d) Each of the Company and each Selling Stockholder acknowledges and agrees that the Underwriters are acting solely in the capacity of an arm's length contractual counterparty to the Company and the Selling Stockholders with respect to the offering of Shares contemplated hereby (including in connection with determining the terms of the offering) and not as a financial advisor or a fiduciary to, or an agent of, the Company, the Selling Stockholders or any other person. Additionally, neither the Representatives nor any other Underwriter is advising the Company, the Selling Stockholders or any other person as to any legal, tax, investment, accounting or regulatory matters in any jurisdiction. The Company and the Selling Stockholders shall consult with their own advisors concerning such matters and each shall be responsible for making its own independent investigation and appraisal of the transactions contemplated hereby, and the Underwriters shall have no responsibility or liability to the Company or the



Selling Stockholders with respect thereto. Any review by the Underwriters of the Company, the transactions contemplated hereby or other matters relating to such transactions will be performed solely for the benefit of the Underwriters and shall not be on behalf of the Company or the Selling Stockholders.

3. Representations and Warranties of the Company. The Company represents and warrants to each Underwriter and to each of the Selling Stockholders that:

(a) *Preliminary Prospectus*. No order preventing or suspending the use of any Preliminary Prospectus has been issued by the Commission, and each Preliminary Prospectus included in the Pricing Disclosure Package, at the time of filing thereof, complied in all material respects with the Securities Act, and no Preliminary Prospectus, at the time of filing thereof, contained any untrue statement of a material fact or omitted to state a material fact necessary in order to make the statements therein, in the light of the circumstances under which they were made, not misleading; provided that the Company makes no representation or warranty with respect to any statements or omissions made in reliance upon and in conformity with information relating to any Underwriter furnished to the Company in writing by such Underwriter through the Representatives expressly for use in any Preliminary Prospectus, it being understood and agreed that the only such information furnished by any Underwriter consists of the information described as such in Section 10(c) hereof; provided further that the Company makes no representation or warranty with respect to any statements or omissions made in reliance upon and in conformity with information relating to any Selling Stockholder furnished to the Company in writing by or on behalf of such Selling Stockholder expressly for use in any Preliminary Prospectus, it being understood and agreed that the only such information furnished by any Selling Stockholder consists of the Selling Stockholder Information (as defined below).

(b) *Pricing Disclosure Package*. The Pricing Disclosure Package as of the Applicable Time did not, and as of the Closing Date and as of the Additional Closing Date, as the case may be, will not, contain any untrue statement of a material fact or omit to state a material fact necessary in order to make the statements therein, in the light of the circumstances under which they were made, not misleading; provided that the Company makes no representation or warranty with respect to any statements or omissions made in reliance upon and in conformity with (i) information relating to any Underwriter furnished to the Company in writing by such Underwriter through the Representatives expressly for use in such Pricing Disclosure Package, it being understood and agreed that the only such information furnished by any Underwriter consists of the information described as such in Section 10(c) hereof or (ii) information relating to any Selling Stockholder that is not an executive officer of the Company furnished to the Company in writing by or on behalf of such Selling Stockholder expressly for use in the Pricing Disclosure Package, it being understood and agreed that the only such information furnished by and on behalf of any Selling Stockholder consists of the Selling Stockholder Information.

(c) *Issuer Free Writing Prospectus*. Other than the Registration Statement, the Preliminary Prospectus and the Prospectus, the Company (including its agents and representatives, other than the Underwriters in their capacity as such) has not prepared, used, authorized, approved or referred to and will not prepare, use, authorize, approve or refer to any "written communication" (as defined in Rule 405 under the Securities Act) that constitutes an offer to sell or solicitation of an offer to buy the Shares (each such communication by the Company or its agents and representatives (other than a communication referred to in clause (i) below) an "Issuer Free Writing Prospectus") other than (i) any document not constituting a prospectus pursuant to Section 2(a)(10)(a) of the Securities Act or Rule 134 under the Securities Act or any document not constituting an offer pursuant to Rule 135 under the Securities Act and (ii) the documents listed on Annex A hereto, each electronic road show and any other written

communications approved in writing in advance by the Representatives, which approval shall not be unreasonably withheld or delayed. Each such Issuer Free Writing Prospectus complies in all material respects with the applicable requirements of the Securities Act, has been or will be (within the time period specified in Rule 433) filed in accordance with the Securities Act (to the extent required thereby) and does not conflict with the information contained in the Registration Statement or the Pricing Disclosure Package, and, when taken together with the Preliminary Prospectus accompanying, or delivered prior to delivery of, such Issuer Free Writing Prospectus, did not, and as of the Closing Date and as of the Additional Closing Date, as the case may be, will not, contain any untrue statement of a material fact or omit to state a material fact necessary in order to make the statements therein, in the light of the circumstances under which they were made, not misleading; provided that the Company makes no representation or warranty with respect to any statements or omissions made in each such Issuer Free Writing Prospectus or Preliminary Prospectus in reliance upon and in conformity with (i) information relating to any Underwriter furnished to the Company in writing by such Underwriter through the Representatives expressly for use in such Issuer Free Writing Prospectus or Preliminary Prospectus and any amendment or supplement thereto, it being understood and agreed that the only such information furnished by any Underwriter consists of the information described as such in Section 10(c) hereof or (ii) information relating to any Selling Stockholder that is not an executive officer of the Company furnished to the Company in writing by or on behalf of such Selling Stockholder expressly for use in the such Issuer Free Writing Prospectus or Preliminary Prospectus and any amendment or supplement thereto, it being understood and agreed that the only such information furnished by and on behalf of any Selling Stockholder consists of the Selling Stockholder Information.

(d) *Emerging Growth Company.* From the time of initial confidential submission of the Registration Statement to the Commission (or, if earlier, the first date on which the Company engaged directly or through any person authorized to act on its behalf in any Testing-the-Waters Communication) through the date hereof, the Company has been and is an “emerging growth company,” as defined in Section 2(a) of the Securities Act (an “Emerging Growth Company”). “Testing-the-Waters Communication” means any oral or written communication with potential investors undertaken in reliance on Section 5(d) of the Securities Act.

(e) *Testing-the-Waters Materials.* The Company (i) has not alone engaged in any Testing-the-Waters Communications other than Testing-the-Waters Communications with the consent of the Representatives with entities that are qualified institutional buyers within the meaning of Rule 144A under the Securities Act or institutions that are accredited investors within the meaning of Rule 501 under the Securities Act and (ii) has not authorized anyone other than the Representatives to engage in Testing-the-Waters Communications. The Company reconfirms that the Representatives have been authorized to act on its behalf in undertaking Testing-the-Waters Communications by virtue of a writing substantially in the form of Exhibit A hereto. The Company has not distributed or approved for distribution any Written Testing-the-Waters Communications other than those listed on Annex B hereto. “Written Testing-the-Waters Communication” means any Testing-the-Waters Communication that is a written communication within the meaning of Rule 405 under the Securities Act. Any individual Written Testing-the-Waters Communication does not conflict with the information contained in the Registration Statement or the Pricing Disclosure Package, complied in all material respects with the Securities Act, and when taken together with the Pricing Disclosure Package as of the Applicable Time, did not, and as of the Closing Date and as of the Additional Closing Date, as the case may be, will not, contain any untrue statement of a material fact or omit to state a material fact necessary in order to make the statements therein, in the light of the circumstances under which they were made, not misleading; provided that the Company makes no representation or warranty with

respect to any statements or omissions made in reliance upon and in conformity with (i) information relating to any Underwriter furnished to the Company in writing by such Underwriter through the Representatives expressly for use in such Written Testing-the-Waters Communications and any amendment or supplement thereto, it being understood and agreed that the only such information furnished by any Underwriter consists of the information described as such in Section 10(c) hereof or (ii) information relating to any Selling Stockholder that is not an executive officer of the Company furnished to the Company in writing by or on behalf of such Selling Stockholder expressly for use in the such Written Testing-the-Waters Communications and Pricing Disclosure Package and any amendment or supplement thereto, it being understood and agreed that the only such information furnished by and on behalf of any Selling Stockholder consists of the Selling Stockholder Information.

(f) *Registration Statement and Prospectus.* The Registration Statement has been declared effective by the Commission. No order suspending the effectiveness of the Registration Statement has been issued by the Commission, and, to the knowledge of the Company, no proceeding for that purpose or pursuant to Section 8A of the Securities Act against the Company or related to the offering of the Shares has been initiated or threatened by the Commission; as of the applicable effective date of the Registration Statement and any post-effective amendment thereto, the Registration Statement and any such post-effective amendment complied and will comply in all material respects with the applicable requirements of the Securities Act, and did not and will not contain any untrue statement of a material fact or omit to state a material fact required to be stated therein or necessary in order to make the statements therein not misleading; and as of the date of the Prospectus and any amendment or supplement thereto and as of the Closing Date and as of the Additional Closing Date, as the case may be, the Prospectus will not contain any untrue statement of a material fact or omit to state a material fact necessary in order to make the statements therein, in the light of the circumstances under which they were made, not misleading; provided that the Company makes no representation or warranty with respect to any statements or omissions made in reliance upon and in conformity with (i) information relating to any Underwriter furnished to the Company in writing by such Underwriter through the Representatives expressly for use in the Registration Statement and the Prospectus and any amendment or supplement thereto, it being understood and agreed that the only such information furnished by any Underwriter consists of the information described as such in Section 10(c) hereof or (ii) information relating to any Selling Stockholder other than an executive officer of the Company furnished to the Company in writing by or on behalf of such Selling Stockholder expressly for use in the Registration Statement and the Prospectus and any amendment or supplement thereto, it being understood and agreed that the only such information furnished by and on behalf of any Selling Stockholder consists of the Selling Stockholder Information.

(g) *Financial Statements.* The financial statements (including the related notes thereto) of the Company and its consolidated subsidiaries included in the Registration Statement, the Pricing Disclosure Package and the Prospectus comply in all material respects with the applicable requirements of the Securities Act and present fairly, in all material respects, the financial position of the Company and its consolidated subsidiaries as of the dates indicated and the results of their operations and the changes in their cash flows for the periods specified; such financial statements have been prepared in conformity with generally accepted accounting principles in the United States (“GAAP”) applied on a consistent basis throughout the periods covered thereby, except in the case of the unaudited financial statements, which are subject to normal year-end adjustments and do not contain certain footnotes permitted by the applicable rules of the Commission; and any supporting schedules included in the Registration Statement present fairly, in all material respects, the information required to be stated therein; and the other historical financial information of the Company and its consolidated subsidiaries included in the

Registration Statement, the Pricing Disclosure Package and the Prospectus has been derived from the accounting records of the Company and its consolidated subsidiaries and presents fairly in all material respects the information shown thereby. The pro forma financial information and the related notes, if any, included in the Registration Statement, the Pricing Disclosure Package and the Prospectus have been properly compiled and prepared in all material respects in accordance with the applicable requirements of the Securities Act and present fairly the information shown therein, and the assumptions used in the preparation thereof are reasonable and the adjustments used therein are appropriate to give effect to the transactions and circumstances referred to therein.

(h) *No Material Adverse Change.* Since the date of the most recent financial statements of the Company included in the Registration Statement, the Pricing Disclosure Package and the Prospectus, (i) there has not been any change in the capital stock (other than the issuance of shares of Class A Common Stock or Class B Common Stock upon exercise of stock options and warrants described as outstanding in, and the grant of options and awards under existing equity incentive plans described in, the Registration Statement, the Pricing Disclosure Package and the Prospectus), any material change in short-term debt or long-term debt of the Company or any of its subsidiaries, or any dividend or distribution of any kind declared, set aside for payment, paid or made by the Company on any class of capital stock, or any material adverse change, or any development involving a prospective material adverse change, in or affecting the business, properties, management, financial position, stockholders' equity or results of operations or prospects of the Company and its subsidiaries taken as a whole; (ii) neither the Company nor any of its subsidiaries has entered into any transaction or agreement (whether or not in the ordinary course of business) that is material to the Company and its subsidiaries taken as a whole or incurred any liability or obligation, direct or contingent, that is material to the Company and its subsidiaries taken as a whole; and (iii) neither the Company nor any of its subsidiaries has sustained any loss or interference with its business that is material to the Company and its subsidiaries taken as a whole and that is either from fire, explosion, flood or other calamity, whether or not covered by insurance, or from any labor disturbance or dispute or any action, order or decree of any court or arbitrator or governmental or regulatory authority, except in each case as otherwise disclosed in the Registration Statement, the Pricing Disclosure Package and the Prospectus.

(i) *Organization and Good Standing.* The Company and each of its Significant Subsidiaries have been duly organized and are validly existing and in good standing under the laws of their respective jurisdictions of organization, are duly qualified to do business and are in good standing in each jurisdiction in which their respective ownership or lease of property or the conduct of their respective businesses requires such qualification, and have all power and authority necessary to own or hold their respective properties and to conduct the businesses in which they are engaged, except where the failure to be so organized, existing, qualified or in good standing or have such power or authority would not reasonably be expected to, individually or in the aggregate, have a material adverse effect on the business, properties, management, financial position, stockholders' equity or results of operations or prospects of the Company and its subsidiaries taken as a whole or on the performance by the Company of its obligations under this Agreement (a "Material Adverse Effect"). The Company does not own or control, directly or indirectly, any corporation, association or other entity other than the subsidiaries listed in Exhibit 21 to the Registration Statement (the "Significant Subsidiaries"), except for subsidiaries that, considered in the aggregate as a single subsidiary, would not constitute a "significant subsidiary" (as defined in Rule 1.02 of Regulation S-X under the Exchange Act).

(j) *Capitalization.* The Company has an authorized capitalization as set forth in the Registration Statement, the Pricing Disclosure Package and the Prospectus under the heading “Capitalization”; all the outstanding shares of capital stock of the Company (including the Shares to be sold by the Selling Stockholders) have been duly authorized and validly issued and are fully paid and non-assessable and are not subject to any pre-emptive or similar rights; except as described in or expressly contemplated by the Pricing Disclosure Package and the Prospectus, there are no outstanding rights (including, without limitation, pre-emptive rights), warrants or options to acquire, or instruments convertible into or exchangeable for, any shares of capital stock or other equity interest in the Company or any of its subsidiaries, or any contract, commitment, agreement, understanding or arrangement of any kind relating to the issuance of any capital stock of the Company or any such subsidiary, any such convertible or exchangeable securities or any such rights, warrants or options; the capital stock of the Company conforms in all material respects to the description thereof contained in the Registration Statement, the Pricing Disclosure Package and the Prospectus; and all the outstanding shares of capital stock or other equity interests of each subsidiary owned, directly or indirectly, by the Company have been duly authorized and validly issued, are fully paid and non-assessable (except as otherwise described in the Registration Statement, the Pricing Disclosure Package and the Prospectus), and are owned directly or indirectly by the Company, free and clear of any lien, charge, encumbrance, security interest, restriction on voting or transfer or any other claim of any third party, other than as described in the Registration Statement, the Pricing Disclosure Package and the Prospectus, including liens, encumbrances and restrictions imposed in connection with or permitted under the debt instruments described under the heading “[ ]”.

(k) *Stock Options.* With respect to the stock options (the “Stock Options”) granted pursuant to the stock-based compensation plans of the Company and its subsidiaries (the “Company Stock Plans”), (i) each Stock Option intended to qualify as an “incentive stock option” under Section 422 of the Code so qualifies, (ii) each grant of a Stock Option was duly authorized no later than the date on which the grant of such Stock Option was by its terms to be effective (the “Grant Date”) by all necessary corporate action, including, as applicable, approval by the board of directors of the Company (or a duly constituted and authorized committee thereof) and any required stockholder approval by the necessary number of votes or written consents, and the award agreement governing such grant (if any) was duly executed and delivered by each party thereto, (iii) each such grant was made in accordance with the terms of the Company Stock Plans and all other applicable laws and regulatory rules or requirements, and (iv) each such grant was properly accounted for in accordance with GAAP in the financial statements (including the related notes) of the Company.

(l) *Due Authorization.* The Company has full right, power and authority to execute and deliver this Agreement and to perform its obligations hereunder; and all action required to be taken for the due and proper authorization, execution and delivery by it of this Agreement and the consummation by it of the transactions contemplated hereby has been duly and validly taken.

(m) *Underwriting Agreement.* This Agreement has been duly authorized, executed and delivered by the Company.

(n) *The Shares.* The Shares to be issued and sold by the Company hereunder have been duly authorized by the Company and, when issued and delivered and paid for as provided herein, will be duly authorized and validly issued, will be fully paid and nonassessable and will conform in all material respects to the descriptions thereof in the Registration Statement, the Pricing Disclosure Package and the Prospectus; and the issuance of the Shares is not subject to any preemptive or similar rights.

(o) *No Violation or Default.* Neither the Company nor any of its subsidiaries is (i) in violation of its charter or by-laws or similar organizational documents; (ii) in default, and no event has occurred that, with notice or lapse of time or both, would constitute such a default, in the due performance or observance of any term, covenant or condition contained in any indenture, mortgage, deed of trust, loan agreement or other agreement or instrument to which the Company or any of its subsidiaries is a party or by which the Company or any of its subsidiaries is bound or to which any property or asset of the Company or any of its subsidiaries is subject; or (iii) in violation of any law or statute applicable to the Company or any subsidiary or any judgment, order, rule or regulation of any court or arbitrator or governmental or regulatory authority having jurisdiction over the Company or any of its subsidiaries, except, in the case of clauses (ii) and (iii) above, for any such default or violation that would not reasonably be expected to, individually or in the aggregate, have a Material Adverse Effect.

(p) *No Conflicts.* The execution, delivery and performance by the Company of this Agreement, the issuance and sale of the Shares by the Company, the issuance by the Company of the Shares to be issued upon the exercise of the Options (as hereinafter defined) and the consummation by the Company of the transactions contemplated by this Agreement or the Pricing Disclosure Package and the Prospectus will not (i) conflict with or result in a breach or violation of any of the terms or provisions of, or constitute a default under, result in the termination, modification or acceleration of, or result in the creation or imposition of any lien, charge or encumbrance upon any property, right or asset of the Company or any of its subsidiaries pursuant to, any indenture, mortgage, deed of trust, loan agreement or other agreement or instrument to which the Company or any of its subsidiaries is a party or by which the Company or any of its subsidiaries is bound or to which any property, right or asset of the Company or any of its subsidiaries is subject, (ii) result in any violation of the provisions of the charter or by-laws or similar organizational documents of the Company or any of its subsidiaries or (iii) result in the violation of any law or statute applicable to the Company or any subsidiary or any judgment, order, rule or regulation of any court or arbitrator or governmental or regulatory authority having jurisdiction over the Company or any of its subsidiaries, except, in the case of clauses (i) and (iii) above, for any such conflict, breach, violation, default, lien, charge or encumbrance that would not reasonably be expected to, individually or in the aggregate, have a Material Adverse Effect.

(q) *No Consents Required.* No consent, approval, authorization, order, registration or qualification of or with any court or arbitrator or governmental or regulatory authority is required for the execution, delivery and performance by the Company of this Agreement, the issuance and sale of the Shares and the consummation of the transactions contemplated by this Agreement, except for (i) the registration of the Shares under the Securities Act, (ii) such consents, approvals, authorizations, orders and registrations or qualifications as may be required by the Nasdaq Global Market (the "Exchange"), FINRA and under applicable state securities laws in connection with the purchase and distribution of the Shares by the Underwriters or (iii) such consents, approvals, authorizations, orders, licenses, registrations or qualifications as shall have been obtained or made prior to the Closing Date.

(r) *Legal Proceedings.* Except as described in the Registration Statement, the Pricing Disclosure Package and the Prospectus, there are no legal, governmental or regulatory investigations, actions, demands, claims, suits, arbitrations or proceedings ("Actions") pending to which the Company or any of its subsidiaries is a party or to which any property of the Company or any of its subsidiaries is the subject that, individually or in the aggregate, if determined adversely to the Company or any of its subsidiaries, would reasonably be expected to have a Material Adverse Effect; no such Actions are, to the knowledge of the Company, threatened or contemplated by any governmental or regulatory authority or threatened by others; and (i) there

are no current or pending Actions that are required under the Securities Act to be described in the Registration Statement, the Pricing Disclosure Package or the Prospectus that are not so described in the Registration Statement, the Pricing Disclosure Package and the Prospectus and (ii) there are no statutes, regulations or contracts or other documents that are required under the Securities Act to be filed as exhibits to the Registration Statement or described in the Registration Statement, the Pricing Disclosure Package or the Prospectus that are not so filed as exhibits to the Registration Statement or described in the Registration Statement, the Pricing Disclosure Package and the Prospectus.

(s) *Independent Accountants.* Ernst & Young LLP, who have certified certain financial statements of the Company and its subsidiaries, is an independent registered public accounting firm with respect to the Company and its subsidiaries within the applicable rules and regulations adopted by the Commission and the Public Company Accounting Oversight Board (United States) and as required by the Securities Act.

(t) *Title to Real and Personal Property.* The Company and its subsidiaries have good and marketable title in fee simple (in the case of real property) to, or have valid rights to lease or otherwise use, all items of real and personal property that are material to the respective businesses of the Company and its subsidiaries, in each case free and clear of all liens, encumbrances, claims and defects and imperfections of title except those that (i) are otherwise disclosed in the Registration Statement, the Pricing Disclosure Package and the Prospectus, (ii) do not materially interfere with the use made and proposed to be made of such property by the Company and its subsidiaries or (iii) could not reasonably be expected, individually or in the aggregate, to have a Material Adverse Effect.

(u) *Intellectual Property.* The Company and its subsidiaries each own or possess the right to use all material patents, patent rights, trademarks, trade names, service marks and service names (including all goodwill associated with use of the same), copyrights, license rights, inventions, know-how (including trade secrets and other unpatented and unpatentable proprietary or confidential information, systems or procedures) and other technology and intellectual property rights, including the right to sue for past, present and future infringement, misappropriation or dilution of any of the same (“Intellectual Property”) necessary for the conduct of their business as currently conducted and as proposed to be conducted in the Registration Statement, the Pricing Disclosure Package and the Prospectus (“Company Intellectual Property”). Except as described in the Registration Statement, the Pricing Disclosure Package and the Prospectus, (i) there are no third parties who have or will be able to establish rights to any Company Intellectual Property, except for the retained rights of the owners of Company Intellectual Property which is licensed to the Company or its subsidiaries, and neither the Company nor any of its subsidiaries is aware of any facts which could form a reasonable basis for any such action, suit, proceeding or claim; (ii) there is no pending or, to the knowledge of the Company, threatened action, suit, proceeding or claim by others challenging the Company’s rights or any of its subsidiaries’ rights in or to any Company Intellectual Property, and neither the Company nor any of its subsidiaries is aware of any facts which could form a reasonable basis for any such action, suit, proceeding or claim; (iii) there is no pending or, to the knowledge of the Company, threatened action, suit, proceeding or claim by others challenging the validity, enforceability or scope of any Company Intellectual Property, and neither the Company nor any of its subsidiaries is aware of any facts which could form a reasonable basis for any such action, suit, proceeding or claim; (iv) there is no pending or, to the knowledge of the Company, threatened action, suit, proceeding or claim by others that the Company or any of its subsidiaries infringes or misappropriates any Intellectual Property or other proprietary rights of others, and neither the Company nor any of its subsidiaries is aware of any facts which could form a reasonable basis for any such action, suit, proceeding or claim; (v) there

is no patent or patent application that contains claims that interfere with or otherwise challenged the issued or pending claims of any Company Intellectual Property; and (vi) no Company Intellectual Property has been obtained or is being used by the Company or any of its subsidiaries in violation of any contractual obligation binding on the Company or any of its subsidiaries, or otherwise in violation of the rights of any persons. The Company and its subsidiaries have taken all steps necessary to secure interests in the Company Intellectual Property from their employees, consultants, agents and contractors. There are no outstanding options, licenses or agreements of any kind relating to the Company Intellectual Property owned by the Company or any of its subsidiaries that are required to be described in the Registration Statement, the General Disclosure Package and the Prospectus and are not described in all material respects. The Company and its subsidiaries are not a party to or bound by any options, licenses or agreements with respect to the Intellectual Property of any other person or entity that are required to be set forth in the Prospectus and are not described in all material respects. No government funding, facilities or resources of a university, college, other educational institution or research center or funding from third parties was used in the development of any Company Intellectual Property that is owned or purported to be owned by the Company or any of its subsidiaries, and no governmental agency or body, university, college, other educational institution or research center has any claim or right in or to any Company Intellectual Property that is owned or purported to be owned by the Company or any of its subsidiaries. The Company and its subsidiaries have used all software and other materials distributed under a “free,” “open source,” or similar licensing model (including but not limited to the GNU General Public License, GNU Lesser General Public License and GNU Affero General Public License) (“Open Source Materials”) in compliance with all license terms applicable to such Open Source Materials. Neither the Company nor any of its subsidiaries has used or distributed any Open Source Materials in a manner that requires or has required (i) the Company or any of its subsidiaries to permit reverse-engineering of any products or services of the Company or any of its subsidiaries, or any software code or other technology owned by the Company or any of its subsidiaries; or (ii) any products or services of the Company or any of its subsidiaries, or any software code or other technology owned by the Company or any of its subsidiaries, to be (A) disclosed or distributed in source code form, (B) licensed for the purpose of making derivative works, or (C) redistributable at no charge.

(v) *No Undisclosed Relationships.* No relationship, direct or indirect, exists between or among the Company or any of its subsidiaries, on the one hand, and the directors, officers, stockholders, customers, suppliers or other affiliates of the Company or any of its subsidiaries, on the other, that is required by the Securities Act to be described in each of the Registration Statement and the Prospectus and that is not so described in such documents and in the Pricing Disclosure Package.

(w) *Investment Company Act.* The Company is not and, after giving effect to the offering and sale of the Shares and the application of the proceeds thereof received by the Company as described in the Registration Statement, the Pricing Disclosure Package and the Prospectus, will not be required to register as an “investment company” or an entity “controlled” by an “investment company” within the meaning of the Investment Company Act of 1940, as amended, and the rules and regulations of the Commission thereunder (collectively, the “Investment Company Act”).

(x) *Taxes.* The Company and its subsidiaries have paid all federal, state, local and foreign taxes and filed all tax returns required to be paid or filed through the date hereof (except in any case in which failure to pay or file (as applicable) would not reasonably be expected to have a Material Adverse Effect, and except for any taxes being contested in good faith); and except as otherwise disclosed in the Registration Statement, the Pricing Disclosure Package and



the Prospectus, there is no tax deficiency that has been asserted against the Company or any of its subsidiaries or any of their respective properties or assets (except for any tax deficiency that is currently being contested in good faith or as would not reasonably be expected to have a Material Adverse Effect).

(y) *Licenses and Permits.* The Company and its subsidiaries possess all licenses, sub-licenses, certificates, permits and other authorizations issued by, and have made all declarations and filings with, the appropriate federal, state, local or foreign governmental or regulatory authorities that are necessary for the ownership or lease of their respective properties or the conduct of their respective businesses as described in the Registration Statement, the Pricing Disclosure Package and the Prospectus, except where the failure to possess or make the same would not, individually or in the aggregate, have a Material Adverse Effect; and except as described in the Registration Statement, the Pricing Disclosure Package and the Prospectus, neither the Company nor any of its subsidiaries has received notice of any revocation or modification of any such license, sub-license, certificate, permit or authorization or has any reason to believe that any such license, sub-license, certificate, permit or authorization will not be renewed in the ordinary course, in each case, except where such revocation or modification would not reasonably be expected to have a Material Adverse Effect.

(z) *No Labor Disputes.* No labor disturbance by or dispute with employees of the Company or any of its subsidiaries exists or, to the knowledge of the Company, is contemplated or threatened, and the Company is not aware of any existing or imminent labor disturbance by, or dispute with, the employees of any of its or its subsidiaries' principal suppliers, contractors or customers, except in each case as would not reasonably be expected to have a Material Adverse Effect. Neither the Company nor any of its subsidiaries has received any notice of cancellation or termination with respect to any collective bargaining agreement to which it is a party.

(aa) *Certain Environmental Matters.* (i) The Company and its subsidiaries (x) are, and have at all times been, in compliance with all, and have not violated any, applicable federal, state, local and foreign laws (including common law), rules, regulations, requirements, decisions, judgments, decrees, orders and other legally enforceable requirements relating to pollution or the protection of human health or safety, the environment, natural resources, hazardous or toxic substances or wastes, pollutants or contaminants (collectively, "Environmental Laws"); (y) have received and are, and have at all times been, in compliance with all, and have not violated any, applicable permits, licenses, certificates or other authorizations or approvals required of them under any Environmental Laws to conduct their respective businesses; and (z) have not received notice of any actual or potential liability or obligation under or relating to, or any actual or potential violation of, any Environmental Laws, including for the investigation or remediation of any disposal or release of hazardous or toxic substances or wastes, pollutants or contaminants, and have no knowledge of any event or condition that would reasonably be expected to result in any such notice, and (ii) there are no costs or liabilities associated with Environmental Laws, or concerning hazardous or toxic substances or wastes, pollutants or contaminants, of or relating to the Company or its subsidiaries, except in the case of each of (i) and (ii) above, for any such matter as would not, individually or in the aggregate, reasonably be expected to have a Material Adverse Effect; and (iii) except as described in each of the Pricing Disclosure Package and the Prospectus, (x) there is no proceeding that is pending, or that is known to be contemplated, against the Company or any of its subsidiaries under any Environmental Laws in which a governmental entity is also a party, other than such proceeding regarding which it is reasonably believed no monetary sanctions of \$100,000 or more will be imposed, (y) the Company and its subsidiaries are not aware of any facts or issues regarding compliance with Environmental Laws, or liabilities or other obligations under Environmental Laws or concerning hazardous or toxic

substances or wastes, pollutants or contaminants, that could reasonably be expected to have a material effect on the capital expenditures, earnings or competitive position of the Company and its subsidiaries, and (z) none of the Company or its subsidiaries anticipates material capital expenditures relating to any Environmental Laws.

(bb) *Compliance with ERISA.* (i) Each employee benefit plan, within the meaning of Section 3(3) of the Employee Retirement Income Security Act of 1974, as amended (“ERISA”), for which the Company or any member of its “Controlled Group” (defined as any entity, whether or not incorporated, that is under common control with the Company within the meaning of Section 4001(a)(14) of ERISA or any entity that would be regarded as a single employer with the Company under Section 414(b),(c),(m) or (o) of the Internal Revenue Code of 1986, as amended (the “Code”)) would have any liability (each, a “Plan”) has been maintained in compliance with its terms and the requirements of any applicable statutes, orders, rules and regulations, including but not limited to ERISA and the Code; (ii) no prohibited transaction, within the meaning of Section 406 of ERISA or Section 4975 of the Code, has occurred with respect to any Plan, excluding transactions effected pursuant to a statutory or administrative exemption; (iii) for each Plan that is subject to the funding rules of Section 412 of the Code or Section 302 of ERISA, no Plan has failed (whether or not waived), or is reasonably expected to fail, to satisfy the minimum funding standards (within the meaning of Section 302 of ERISA or Section 412 of the Code) applicable to such Plan; (iv) no Plan is, or is reasonably expected to be, in “at risk status” (within the meaning of Section 303(i) of ERISA) and no Plan that is a “multiemployer plan” within the meaning of Section 4001(a)(3) of ERISA is in “endangered status” or “critical status” (within the meaning of Sections 304 and 305 of ERISA) (v) the fair market value of the assets of each Plan exceeds the present value of all benefits accrued under such Plan (determined based on those assumptions used to fund such Plan); (vi) no “reportable event” (within the meaning of Section 4043(c) of ERISA and the regulations promulgated thereunder) has occurred or is reasonably expected to occur; (vii) each Plan that is intended to be qualified under Section 401(a) of the Code has received a favorable determination letter or is comprised of a master or prototype plan that has received an opinion letter from the Internal Revenue Service covering all tax law changes (or has submitted, or is within the remedial amendment period for submitting, an application for a determination letter and is awaiting a response from the Internal Revenue Service), and, to the knowledge of the Company, no event has occurred that would result in the revocation or failure to issue any such determination letter or opinion letter.; (viii) neither the Company nor any member of the Controlled Group has incurred, nor reasonably expects to incur, any liability under Title IV of ERISA (other than contributions to the Plan or premiums to the Pension Benefit Guarantee Corporation, in the ordinary course and without default) in respect of a Plan (including a “multiemployer plan” within the meaning of Section 4001(a)(3) of ERISA); and (ix) none of the following events has occurred or is reasonably likely to occur: (A) a material increase in the aggregate amount of contributions required to be made to all Plans by the Company or its Controlled Group affiliates in the current fiscal year of the Company and its Controlled Group affiliates compared to the amount of such contributions made in the Company’s and its Controlled Group affiliates’ most recently completed fiscal year; or (B) a material increase in the Company and its subsidiaries’ “accumulated post-retirement benefit obligations” (within the meaning of Accounting Standards Codification Topic 715-60) compared to the amount of such obligations in the Company and its subsidiaries’ most recently completed fiscal year, except in each case with respect to the events or conditions set forth in (i) through (ix) hereof, as would not, individually or in the aggregate, have a Material Adverse Effect.

(cc) *Disclosure Controls.* The Company and its subsidiaries maintain an effective system of “disclosure controls and procedures” (as defined in Rule 13a-15(e) of the Securities Exchange Act of 1934, as amended (the “Exchange Act”)) that are designed to comply with the

applicable requirements of the Exchange Act and to ensure that information required to be disclosed by the Company in reports that it files or submits under the Exchange Act is recorded, processed, summarized and reported within the time periods specified in the Commission's rules and forms, including controls and procedures designed to ensure that such information is accumulated and communicated to the Company's management as appropriate to allow timely decisions regarding required disclosure.

(dd) *Accounting Controls.* The Company and its subsidiaries maintain systems of "internal control over financial reporting" (as defined in Rule 13a-15(f) of the Exchange Act) that are designed to comply with the applicable requirements of the Exchange Act and have been designed by, or under the supervision of, their respective principal executive and principal financial officers, or persons performing similar functions, to provide reasonable assurance regarding the reliability of financial reporting and the preparation of financial statements for external purposes in accordance with GAAP. The Company and its subsidiaries maintain internal accounting controls sufficient to provide reasonable assurance that (i) transactions are executed in accordance with management's general or specific authorizations; (ii) transactions are recorded as necessary to permit preparation of financial statements in conformity with GAAP and to maintain asset accountability; (iii) access to assets is permitted only in accordance with management's general or specific authorization; and (iv) the recorded accountability for assets is compared with the existing assets at reasonable intervals and appropriate action is taken with respect to any differences. Except as disclosed in the Registration Statement, the Pricing Disclosure Package and the Prospectus, there are no material weaknesses in the Company's internal controls. The Company's auditors and the Audit Committee of the Board of Directors of the Company have been advised of: (i) all significant deficiencies and material weaknesses in the design or operation of internal controls over financial reporting which have adversely affected or are reasonably likely to adversely affect the Company's ability to record, process, summarize and report financial information; and (ii) any fraud, whether or not material, that involves management or other employees who have a significant role in the Company's internal controls over financial reporting.

(ee) *Insurance.* The Company and its subsidiaries have insurance covering their respective properties, operations, personnel and businesses, including business interruption insurance, which insurance is in amounts and insures against such losses and risks as are customary for businesses such as the Company's and its subsidiaries and their respective businesses; and neither the Company nor any of its subsidiaries has (i) received notice from any insurer or agent of such insurer that capital improvements or other expenditures are required or necessary to be made in order to continue such insurance or (ii) any reason to believe that it will not be able to renew its existing insurance coverage as and when such coverage expires or to obtain similar coverage at reasonable cost from similar insurers as may be necessary to continue its business in all material respects.

(ff) *No Unlawful Payments.* Neither the Company nor any of its subsidiaries nor any director or officer of the Company nor, to the knowledge of the Company, any employee of the Company or any director or officer of its subsidiaries or any agent, affiliate or other person acting on behalf of the Company or any of its subsidiaries has (i) used any corporate funds for any unlawful contribution, gift, entertainment or other unlawful expense relating to political activity; (ii) made or taken an act in furtherance of an offer, promise or authorization of any direct or indirect unlawful payment or benefit to any foreign or domestic government official or employee, including of any government-owned or controlled entity or of a public international organization, or any person acting in an official capacity for or on behalf of any of the foregoing, or any political party or party official or candidate for political office; (iii) violated or is in violation of

any applicable provision of the Foreign Corrupt Practices Act of 1977, as amended, or any applicable law or regulation implementing the OECD Convention on Combating Bribery of Foreign Public Officials in International Business Transactions, or committed an offence under the Bribery Act 2010 of the United Kingdom or any other applicable anti-bribery or anti-corruption law; or (iv) made, offered, agreed, requested or taken an act in furtherance of any unlawful bribe or other unlawful benefit, including, without limitation, any rebate, payoff, influence payment, kickback or other unlawful or improper payment or benefit. The Company and its subsidiaries have instituted, maintain and enforce policies and procedures designed to promote and ensure compliance with all applicable anti-bribery and anti-corruption laws.

(gg) *Compliance with Anti-Money Laundering Laws.* The operations of the Company and its subsidiaries are and have been conducted at all times in compliance with applicable financial recordkeeping and reporting requirements, including those of the Currency and Foreign Transactions Reporting Act of 1970, as amended, the applicable money laundering statutes of all jurisdictions where the Company or any of its subsidiaries conducts business, the rules and regulations thereunder and any related or similar rules, regulations or guidelines issued, administered or enforced by any governmental agency (collectively, the “Anti-Money Laundering Laws”) and no action, suit or proceeding by or before any court or governmental agency, authority or body or any arbitrator involving the Company or any of its subsidiaries with respect to the Anti-Money Laundering Laws is pending or, to the knowledge of the Company, threatened.

(hh) *No Conflicts with Sanctions Laws.* Neither the Company nor any of its subsidiaries, directors or officers, nor, to the knowledge of the Company, any employee of the Company or any subsidiary or any agent, affiliate or other person acting on behalf of the Company or any of its subsidiaries is currently the subject or the target of any sanctions administered or enforced by the U.S. government, (including, without limitation, the Office of Foreign Assets Control of the U.S. Department of the Treasury (“OFAC”) or the U.S. Department of State and including, without limitation, the designation as a “specially designated national” or “blocked person”), the United Nations Security Council (“UNSC”), the European Union, Her Majesty’s Treasury (“HMT”) or other relevant sanctions authority (collectively, “Sanctions”), nor is the Company or any of its subsidiaries located, organized or resident in a country or territory that is the subject or the target of Sanctions, including Cuba, Iran, North Korea, Sudan, Syria and Crimea (each, a “Sanctioned Country”); and the Company will not directly or indirectly use the proceeds of the offering of the Shares hereunder, or lend, contribute or otherwise make available such proceeds to any subsidiary, joint venture partner or other person or entity (i) to fund or facilitate any activities of or business with any person that, at the time of such funding or facilitation, is the subject or target of Sanctions, (ii) to fund or facilitate any activities of or business in any Sanctioned Country or (iii) in any other manner that will result in a violation by any person (including any person participating in the transaction, whether as underwriter, advisor, investor or otherwise) of applicable Sanctions. For the past five years, the Company and its subsidiaries have not knowingly engaged in and are not now knowingly engaged in any dealings or transactions with any person that at the time of the dealing or transaction is or was the subject or the target of Sanctions or with any Sanctioned Country in violation of applicable Sanctions.

(ii) *No Restrictions on Subsidiaries.* Except as disclosed in the Registration Statement, the Pricing Disclosure Package and the Prospectus, no subsidiary of the Company is currently prohibited, directly or indirectly, under any agreement or other instrument to which it is a party or is subject, from paying any dividends to the Company, from making any other distribution on such subsidiary’s capital stock or similar ownership interest, from repaying to the Company any loans or advances to such subsidiary from the Company or from transferring any of such subsidiary’s properties or assets to the Company or any other subsidiary of the Company.

(jj) *No Broker's Fees.* Neither the Company nor any of its subsidiaries is a party to any contract, agreement or understanding with any person (other than this Agreement) that would give rise to a valid claim against any of them or any Underwriter for a brokerage commission, finder's fee or like payment in connection with the offering and sale of the Shares.

(kk) *No Registration Rights.* No person has the right to require the Company or any of its subsidiaries to register any securities for sale under the Securities Act by reason of the filing of the Registration Statement with the Commission, the issuance and sale of the Shares by the Company or, to the knowledge of the Company, the sale of the Shares to be sold by the Selling Stockholders hereunder.

(ll) *No Stabilization.* The Company has not taken, directly or indirectly, without giving effect to activities of the Underwriters, any action designed to or that would reasonably be expected to cause or result in any stabilization or manipulation of the price of the Shares.

(mm) *Margin Rules.* The application of the proceeds received by the Company from the issuance, sale and delivery of the Shares by the Company as described in each of the Registration Statement, the Pricing Disclosure Package and the Prospectus will not violate Regulation T, U or X of the Board of Governors of the Federal Reserve System or any other regulation of such Board of Governors.

(nn) *Forward-Looking Statements.* No forward-looking statement (within the meaning of Section 27A of the Securities Act and Section 21E of the Exchange Act) included in any of the Registration Statement, the Pricing Disclosure Package or the Prospectus has been made or reaffirmed without a reasonable basis or has been disclosed other than in good faith.

(oo) *Statistical and Market Data.* Nothing has come to the attention of the Company that has caused the Company to believe that the statistical and market-related data included in each of the Registration Statement, the Pricing Disclosure Package and the Prospectus is not based on or derived from sources that are reliable and accurate in all material respects.

(pp) *The Options.* The unissued Shares issuable upon the exercise of options (the "Options") to be exercised by certain of the Selling Stockholders (the "Optionholders") have been duly authorized by the Company and validly reserved for issuance, and at the time of delivery to the Underwriters with respect to such Shares, such Shares will be issued and delivered in all material respects in accordance with the provisions of the Stock Option Agreements between the Company and such Selling Stockholders pursuant to which such Options were granted (the "Option Agreements") and such Shares will be validly issued, fully paid and non-assessable and will conform to the description thereof in the Pricing Disclosure Package and the Prospectus.

(qq) *The Option Agreements.* The Options were duly authorized and issued pursuant to the Option Agreements and constitute valid and binding obligations of the Company and the Optionholders are entitled to the benefits provided by the Option Agreements; the Option Agreements were duly authorized, executed and delivered and constitute valid and legally binding agreements enforceable against the Company in accordance with their terms except as enforceability may be limited by applicable bankruptcy, insolvency or similar laws affecting creditors' rights generally or by equitable principles relating to enforceability; and the Options and the Option Agreements conform to the descriptions thereof in the Pricing Disclosure Package and the Prospectus.

(rr) *Sarbanes-Oxley Act*. There is and has been no failure on the part of the Company or, to the knowledge of the Company, any of the Company's directors or officers, in their capacities as such, to comply in all material respects with any provision of the Sarbanes-Oxley Act of 2002, as amended and the rules and regulations promulgated in connection therewith (the "Sarbanes-Oxley Act"), applicable as of the effective date of the Registration Statement, including Section 402 related to loans and Sections 302 and 906 related to certifications.

(ss) *Status under the Securities Act*. At the time of filing the Registration Statement and any post-effective amendment thereto, at the earliest time thereafter that the Company or any offering participant made a *bona fide* offer (within the meaning of Rule 164(h)(2) under the Securities Act) of the Shares and at the date hereof, the Company was not and is not an "ineligible issuer," as defined in Rule 405 under the Securities Act.

(tt) *No Ratings*. There are (and prior to the Closing Date, will be) no debt securities or preferred stock issued or guaranteed by the Company or any of its subsidiaries that are rated by a "nationally recognized statistical rating organization", as such term is defined under Section 3(a)(62) under the Exchange Act.

4. Representations and Warranties of the Selling Stockholders. Each of the Selling Stockholders, severally and not jointly, represents and warrants to each Underwriter and the Company that:

(a) *Required Consents; Authority*. All consents, approvals, authorizations and orders necessary for the execution and delivery by such Selling Stockholder of this Agreement and the Power of Attorney (the "Power of Attorney") and the Custody Agreement (the "Custody Agreement") hereinafter referred to, and for the sale and delivery of the Shares to be sold by such Selling Stockholder hereunder, have been obtained, except (i) such as has been obtained or will be obtained prior to the Closing Date, (ii) such as may be required by the Securities Act, the Exchange Act, the rules of the Exchange, FINRA or the securities or Blue Sky laws of the various states in connection with the offer and sale of the Shares or (iii) such that would not have a material adverse effect on the ability of such Selling Stockholder to consummate the transactions contemplated by this Agreement; such Selling Stockholder has full right, power and authority to enter into this Agreement, the Power of Attorney and the Custody Agreement and to sell, assign, transfer and deliver the Shares to be sold by such Selling Stockholder hereunder; and this Agreement, the Power of Attorney and the Custody Agreement have each been duly authorized, executed and delivered by such Selling Stockholder.

(b) *No Conflicts*. The execution, delivery and performance by such Selling Stockholder of this Agreement, the Power of Attorney and the Custody Agreement, the sale of the Shares to be sold by such Selling Stockholder and the consummation by such Selling Stockholder of the transactions contemplated herein or therein will not (i) conflict with or result in a breach or violation of any of the terms or provisions of, or constitute a default under, result in the termination, modification or acceleration of, or result in the creation or imposition of any lien, charge or encumbrance upon any property, right or asset of such Selling Stockholder pursuant to, any indenture, mortgage, deed of trust, loan agreement or other agreement or instrument to which such Selling Stockholder is a party or by which such Selling Stockholder is bound or to which any of the property, right or asset of such Selling Stockholder is subject, (ii) result in any violation of the provisions of the charter or by-laws or similar organizational documents of such Selling Stockholder or (iii) result in the violation of any law or statute or any judgment, order, rule or regulation of any court or arbitrator or governmental or regulatory agency except in the case of clauses (i) and (iii) where such conflict, breach, violation, default, lien, charge or encumbrance would not, singly or in the aggregate, have a material adverse effect on such Selling Stockholder's ability to perform its obligations under this Agreement.

(c) *Title to Shares.* Such Selling Stockholder has good and valid title to the Shares to be sold at the Closing Date by such Selling Stockholder hereunder (other than the Shares to be issued upon exercise of Options), free and clear of all liens, encumbrances, equities or adverse claims; such Selling Stockholder will have, immediately prior to the Closing Date, assuming due issuance of any Shares to be issued upon exercise of Options, good and valid title to the Shares to be sold at the Closing Date by such Selling Stockholder, free and clear of all liens, encumbrances, equities or adverse claims; and, upon delivery of the certificates representing such Shares and payment therefor pursuant hereto, good and valid title to such Shares, free and clear of all liens, encumbrances, equities or adverse claims, will pass to the several Underwriters.

(d) *No Stabilization.* Such Selling Stockholder has not taken and will not take, directly or indirectly, any action designed to or that would reasonably be expected to cause or result in any stabilization or manipulation of the price of the Shares.

(e) *Pricing Disclosure Package.* The Pricing Disclosure Package, at the Applicable Time did not, and as of the Closing Date and as of the Additional Closing Date, as the case may be, will not, contain any untrue statement of a material fact or omit to state a material fact necessary in order to make the statements therein, in the light of the circumstances under which they were made, not misleading; provided that the representations and warranties set forth in this Section 4(e) are limited solely to those statements or omissions made in reliance upon and in conformity with the Selling Stockholder Information (as defined below) furnished by such Selling Stockholder. Each Underwriter, the Company and each Selling Stockholder agree that the "Selling Stockholder Information" consists solely of the information furnished by such Selling Stockholder for use in connection with the offering in the Registration Statement, the Pricing Disclosure Package and the Prospectus, which solely consists of (i) the name and address of such Selling Stockholder, (ii) the number of shares of Class A Common Stock and Class B Common Stock owned before and after the offering, the number of Shares proposed to be offered, (iii) the information set forth in the applicable footnote relating to such Selling Stockholder under the beneficial ownership table and (iv) any biographical information, if any, furnished under the caption "*Management*" by such Selling Stockholder or persons employed by or affiliated with such Selling Stockholder (such information with respect to each Selling Stockholder, the "Selling Stockholder Information").

(f) *Issuer Free Writing Prospectus and Written Testing-the-Waters Communication.* Other than the Registration Statement, the Preliminary Prospectus and the Prospectus, such Selling Stockholder (including its agents and representatives, other than the Underwriters in their capacity as such) has not prepared, used, authorized, approved or referred to and will not prepare, use, authorize, approve or refer to any Issuer Free Writing Prospectus or Written Testing-the-Waters Communication, other than (i) any document not constituting a prospectus pursuant to Section 2(a)(10)(a) of the Securities Act or Rule 134 under the Securities Act or (ii) the documents listed on Annex A or Annex B hereto, each electronic road show and any other written communications approved in writing in advance by the Company and the Representative.

(g) *Registration Statement and Prospectus.* As of the applicable effective date of the Registration Statement and any post-effective amendment thereto, the Registration Statement and any such post-effective amendment complied and will comply in all material respects with the applicable requirements of the Securities Act, and did not and will not contain any untrue statement of a material fact or omit to state a material fact required to be stated therein or

necessary in order to make the statements therein not misleading; and as of the date of the Prospectus and any amendment or supplement thereto and as of the Closing Date and as of the Additional Closing Date, as the case may be, the Prospectus will not contain any untrue statement of a material fact or omit to state a material fact necessary in order to make the statements therein, in the light of the circumstances under which they were made, not misleading; provided that such Selling Stockholder's representations and warranties set forth in this Section 4(g) are limited solely to statements or omissions made in reliance upon and in conformity with the Selling Stockholder Information furnished by such Selling Stockholder.

(h) *Preliminary Prospectus.* Each Preliminary Prospectus included in the Pricing Disclosure Package, at the time of filing thereof, complied in all material respects with the Securities Act, and no Preliminary Prospectus, at the time of filing thereof, contained any untrue statement of material fact or omitted to state a fact necessary in order to make the statements therein, in light of the circumstances under which they were made, not misleading; provided that such Selling Stockholder's representations and warranties set forth in this Section 4(h) are limited solely to statements or omissions made in reliance upon and in conformity with the Selling Stockholder Information furnished by such Selling Stockholder.

(i) *Material Information.* As of the date hereof, as of the Closing Date and as of the Additional Closing Date, as the case may be, the sale of the Shares by such Selling Stockholder is not and will not be prompted by any material information concerning the Company which is not set forth in the Registration Statement, the Pricing Disclosure Package or the Prospectus.

(j) *Delivery.* Each of the Selling Stockholders represents and warrants that certificates in negotiable form representing all of the Shares to be sold by such Selling Stockholders hereunder other than any such Shares to be issued upon the exercise of Options, have been, and each of the Selling Stockholders who is selling Shares upon the exercise of Options represents and warrants that duly completed and executed irrevocable Option exercise notices, in the forms specified by the relevant Option Agreement, with respect to all of the Shares to be sold by such Selling Stockholders hereunder have been, placed in custody under a Custody Agreement relating to such Shares, in the form heretofore furnished to you, duly executed and delivered by such Selling Stockholder to [\_\_\_\_], as custodian (the "Custodian"), and that such Selling Stockholder has duly executed and delivered Powers of Attorney, in the form heretofore furnished to you, appointing the person or persons indicated in Schedule 2 hereto, and each of them, as such Selling Stockholder's Attorneys-in-fact (the "Attorneys-in-Fact" or any one of them the "Attorney-in Fact") with authority to execute and deliver this Agreement on behalf of such Selling Stockholder, to determine the purchase price to be paid by the Underwriters to the Selling Stockholders as provided herein, to authorize the delivery of the Shares to be sold by such Selling Stockholder hereunder, to authorize (if applicable) the exercise of the Options to be exercised with respect to the Shares to be sold by such Selling Stockholder hereunder and otherwise to act on behalf of such Selling Stockholder in connection with the transactions contemplated by this Agreement and the Custody Agreement.

Each of the Selling Stockholders specifically agrees that the Shares represented by the certificates or the irrevocable Option exercise notice, in either case held in custody for such Selling Stockholder under the Custody Agreement, are subject to the interests of the Underwriters hereunder, and that the arrangements made by such Selling Stockholder for such custody, and the appointment by such Selling Stockholder of the Attorneys-in-Fact by the Power of Attorney, are to that extent irrevocable. Each of the Selling Stockholders specifically agrees that the obligations of such Selling Stockholder hereunder shall not be terminated by operation of law, whether by the death or incapacity of any individual Selling Stockholder, or, in the case of an estate or



trust, by the death or incapacity of any executor or trustee or the termination of such estate or trust, or in the case of a partnership, corporation or similar organization, by the dissolution of such partnership, corporation or organization, or by the occurrence of any other event. If any individual Selling Stockholder or any such executor or trustee should die or become incapacitated, or if any such estate or trust should be terminated, or if any such partnership, corporation or similar organization should be dissolved, or if any other such event should occur, before the delivery of the Shares hereunder, certificates representing such Shares shall be delivered by or on behalf of such Selling Stockholder in accordance with the terms and conditions of this Agreement and the Custody Agreement, and actions taken by the Attorneys-in-Fact pursuant to the Powers of Attorney shall be as valid as if such death, incapacity, termination, dissolution or other event had not occurred, regardless of whether or not the Custodian, the Attorneys-in-Fact, or any of them, shall have received notice of such death, incapacity, termination, dissolution or other event.

5. Representations and Warranties of the Selling Stockholders that are Executive Officers. Each of the Selling Stockholders that is an executive officer of the Company, severally and not jointly, represents and warrants to each Underwriter and the Company that:

(a) *No Unlawful Payments.* Neither such Selling Stockholder nor, to the knowledge of such Selling Stockholder, any agent, affiliate or other person associated with or acting on behalf of such Selling Stockholder has (i) used any corporate funds for any unlawful contribution, gift, entertainment or other unlawful expense relating to political activity; (ii) made or taken an act in furtherance of an offer, promise or authorization of any direct or indirect unlawful payment or benefit to any foreign or domestic government official or employee, including of any government-owned or controlled entity or of a public international organization, or any person acting in an official capacity for or on behalf of any of the foregoing, or any political party or party official or candidate for political office; (iii) violated or is in violation of any provision of the Foreign Corrupt Practices Act of 1977, as amended, or any applicable law or regulation implementing the OECD Convention on Combating Bribery of Foreign Public Officials in International Business Transactions, or committed an offence under the Bribery Act 2010 of the United Kingdom, or any other applicable anti-bribery or anti-corruption law; or (iv) made, offered, agreed, requested or taken an act in furtherance of any unlawful bribe or other unlawful benefit, including, without limitation, any rebate, payoff, influence payment, kickback or other unlawful or improper payment or benefit.

(b) *Compliance with Anti-Money Laundering Laws.* The operations of such Selling Stockholder are and have been conducted at all times in compliance with applicable financial recordkeeping and reporting requirements, including those of the Currency and Foreign Transactions Reporting Act of 1970, as amended, the applicable money laundering statutes of all jurisdictions where such Selling Stockholder conducts business, the rules and regulations thereunder and any related or similar rules, regulations or guidelines, issued, administered or enforced by any governmental agency (collectively, the “Anti-Money Laundering Laws”), and no action, suit or proceeding by or before any court or governmental agency, authority or body or any arbitrator involving such Selling Stockholder with respect to the Anti-Money Laundering Laws is pending or, to the knowledge of such Selling Stockholder, threatened.

(c) *No Conflicts with Sanctions Laws.* Neither such Selling Stockholder nor, to the knowledge of such Selling Stockholder, any agent, affiliate or other person associated with or acting on behalf of such Selling Stockholder is currently the subject or the target of any sanctions administered or enforced by the U.S. government (including, without limitation, the Office of Foreign Assets Control of the U.S. Department of the Treasury (“OFAC”) or the U.S. Department of State and including, without limitation, the designation as a “specially designated national” or

“blocked person”), the United Nations Security Council (“UNSC”), the European Union, Her Majesty’s Treasury (“HMT”) or other relevant sanctions authority (collectively, “Sanctions”), nor is such Selling Stockholder located, organized or resident in a country or territory that is the subject or target of Sanctions, including, without limitation, Cuba, Iran, North Korea, Sudan, Syria and Crimea (each, a “Sanctioned Country”); and such Selling Stockholder will not directly or indirectly use the proceeds of the offering of the Shares hereunder, or lend, contribute or otherwise make available such proceeds to any subsidiary, joint venture partner or other person or entity (i) to fund or facilitate any activities of or business with any person that, at the time of such funding or facilitation, is the subject or target of Sanctions, (ii) to fund or facilitate any activities of or business in any Sanctioned Country or (iii) in any other manner that will result in a violation by any person (including any person participating in the transaction, whether as underwriter, advisor, investor or otherwise) of Sanctions. For the past five years, such Selling Stockholder has not knowingly engaged in, and is not now knowingly engaged in, any dealings or transactions with any person that at the time of the dealing or transaction is or was the subject or the target of Sanctions or with any Sanctioned Country.

6. Further Agreements of the Company. The Company covenants and agrees with each Underwriter that:

(a) *Required Filings.* The Company will file the final Prospectus with the Commission within the time periods specified by Rule 424(b) and Rule 430A under the Securities Act; the Company will file any Issuer Free Writing Prospectus to the extent required by Rule 433 under the Securities Act; and the Company will furnish copies of the Prospectus and each Issuer Free Writing Prospectus (to the extent not previously delivered) to the Underwriters in New York City prior to 10:00 A.M., New York City time, on the business day next succeeding the date of this Agreement in such quantities as the Representatives may reasonably request.

(b) *Delivery of Copies.* The Company will deliver, if requested by the Representatives, without charge, (i) to the Representatives, two signed copies of the Registration Statement as originally filed and each amendment thereto, in each case including all exhibits and consents filed therewith; and (ii) to each Underwriter (A) a conformed copy of the Registration Statement as originally filed and each amendment thereto (without exhibits) and (B) during the Prospectus Delivery Period (as defined below), as many copies of the Prospectus (including all amendments and supplements thereto and each Issuer Free Writing Prospectus) as the Representatives may reasonably request. As used herein, the term “Prospectus Delivery Period” means such period of time after the first date of the public offering of the Shares as in the opinion of counsel for the Underwriters a prospectus relating to the Shares is required by law to be delivered (or required to be delivered but for Rule 172 under the Securities Act) in connection with sales of the Shares by any Underwriter or dealer.

(c) *Amendments or Supplements, Issuer Free Writing Prospectuses.* Before using, authorizing, approving, referring to or filing any Issuer Free Writing Prospectus, and before filing any amendment or supplement to the Registration Statement or the Prospectus, the Company will furnish to the Representatives and counsel for the Underwriters a copy of the proposed Issuer Free Writing Prospectus, amendment or supplement for review and will not use, authorize, approve, refer to or file any such Issuer Free Writing Prospectus or file any such proposed amendment or supplement to which the Representatives reasonably object in a timely manner.

(d) *Notice to the Representatives.* The Company will advise the Representatives promptly, and confirm such advice in writing (which may be by electronic mail), (i) when the Registration Statement has become effective; (ii) when any amendment to the Registration

Statement has been filed or becomes effective; (iii) when any supplement to the Prospectus, any Issuer Free Writing Prospectus or any Written Testing-the-Waters Communication or any amendment to the Prospectus has been filed or distributed; (iv) of any request by the Commission for any amendment to the Registration Statement or any amendment or supplement to the Prospectus or the receipt of any comments from the Commission relating to the Registration Statement or any other request by the Commission for any additional information including, but not limited to, any request for information concerning any Testing-the-Waters Communication; (v) of the issuance by the Commission or any other governmental or regulatory authority of any order suspending the effectiveness of the Registration Statement or preventing or suspending the use of any Preliminary Prospectus, any of the Pricing Disclosure Package, the Prospectus or any Written Testing-the-Waters Communication or the initiation or threatening of any proceeding, if the Company gains knowledge of such proceeding, for that purpose or pursuant to Section 8A of the Securities Act; (vi) of the occurrence of any event or development within the Prospectus Delivery Period as a result of which the Prospectus, any of the Pricing Disclosure Package, any Issuer Free Writing Prospectus or any Written Testing-the-Waters Communication as then amended or supplemented would include any untrue statement of a material fact or omit to state a material fact necessary in order to make the statements therein, in the light of the circumstances existing when the Prospectus, the Pricing Disclosure Package, or any such Issuer Free Writing Prospectus or any Written Testing-the-Waters Communication is delivered to a purchaser, not misleading; and (vii) of the receipt by the Company of any notice with respect to any suspension of the qualification of the Shares for offer and sale in any jurisdiction or the initiation or threatening of any proceeding for such purpose, if the Company gains knowledge of such proceeding; and the Company will use its reasonable best efforts to prevent the issuance of any such order suspending the effectiveness of the Registration Statement, preventing or suspending the use of any Preliminary Prospectus, any of the Pricing Disclosure Package or the Prospectus or any Written Testing-the-Waters Communication or suspending any such qualification of the Shares and, if any such order is issued, will use its reasonable best efforts to obtain as soon as possible the withdrawal thereof.

(e) *Ongoing Compliance.* (1) If during the Prospectus Delivery Period (i) any event or development shall occur or condition shall exist as a result of which the Prospectus as then amended or supplemented would include any untrue statement of a material fact or omit to state any material fact necessary in order to make the statements therein, in the light of the circumstances existing when the Prospectus is delivered to a purchaser, not misleading or (ii) it is necessary to amend or supplement the Prospectus to comply with applicable law, the Company will promptly notify the Underwriters thereof and forthwith prepare and, subject to paragraph (c) above, file with the Commission and furnish to the Underwriters and to such dealers as the Representatives may designate, such amendments or supplements to the Prospectus as may be necessary so that the statements in the Prospectus as so amended or supplemented will not, in the light of the circumstances existing when the Prospectus is delivered to a purchaser, be misleading or so that the Prospectus will comply with applicable law and (2) if at any time prior to the Closing Date (i) any event or development shall occur or condition shall exist as a result of which the Pricing Disclosure Package as then amended or supplemented would include any untrue statement of a material fact or omit to state any material fact necessary in order to make the statements therein, in the light of the circumstances existing when the Pricing Disclosure Package is delivered to a purchaser, not misleading or (ii) it is necessary to amend or supplement the Pricing Disclosure Package to comply with applicable law, the Company will promptly notify the Underwriters thereof and forthwith prepare and, subject to paragraph (c) above, file with the Commission (to the extent required) and furnish to the Underwriters and to such dealers as the Representatives may designate, such amendments or supplements to the Pricing Disclosure Package as may be necessary so that the statements in the Pricing Disclosure Package as so amended or supplemented will not, in the light of the circumstances existing when the Pricing Disclosure Package is delivered to a purchaser, be misleading or so that the Pricing Disclosure Package will comply with applicable law.

(f) *Blue Sky Compliance.* If required by applicable law, the Company will qualify the Shares for offer and sale under the securities or Blue Sky laws of such jurisdictions as the Representatives shall reasonably request and will continue such qualifications in effect so long as required for distribution of the Shares; provided that the Company shall not be required to (i) qualify as a foreign corporation or other entity or as a dealer in securities in any such jurisdiction where it would not otherwise be required to so qualify, (ii) file any general consent to service of process in any such jurisdiction or (iii) subject itself to taxation in any such jurisdiction if it is not otherwise so subject.

(g) *Earning Statement.* The Company will make generally available to its security holders and the Representatives as soon as practicable an earnings statement that satisfies the provisions of Section 11(a) of the Securities Act and Rule 158 of the Commission promulgated thereunder covering a period of at least twelve months beginning with the first fiscal quarter of the Company occurring after the “effective date” (as defined in Rule 158) of the Registration Statement.

(h) *Clear Market.* For a period of 180 days after the date of the Prospectus, the Company will not (i) offer, pledge, sell, contract to sell, sell any option or contract to purchase, purchase any option or contract to sell, grant any option, right or warrant to purchase, or otherwise transfer or dispose of, directly or indirectly, or file with the Commission a registration statement under the Securities Act relating to, any shares of Stock or any securities convertible into or exercisable or exchangeable for Stock, or publicly disclose the intention to make any offer, sale, pledge, disposition or filing, or (ii) enter into any swap or other agreement that transfers, in whole or in part, any of the economic consequences of ownership of the Stock or any such other securities, whether any such transaction described in clause (i) or (ii) above is to be settled by delivery of Stock or such other securities, in cash or otherwise, without the prior written consent of the Representatives, other than (1) the Shares to be sold hereunder, (2) any shares of Stock of the Company awarded, issued upon the exercise of options or purchase rights, issued upon vesting of equity awards and/or settlement of other awards granted under the Company Stock Plans, (3) the filing by the Company of registration statements on Form S-8 with respect to benefit plans described in the Registration Statement, the Pricing Disclosure Package and the Prospectus and (4) the issuance by the Company of Common Stock and securities convertible or exercisable or exchangeable for Common Stock, in an aggregate amount not to exceed five percent (5%) of the Company’s outstanding securities, determined as of the Closing Date, in connection with one more acquisitions of a company or a business, securities, property or assets of another person or entity, joint ventures, commercial relationships or strategic alliances.

If the Representatives, in their sole discretion, agree to release or waive the restrictions set forth in Section 7(a) or a lock-up letter described in Section 9(l) hereof for an officer or director of the Company and provide the Company with notice of the impending release or waiver substantially in the form of Exhibit B hereto at least three business days before the effective date of the release or waiver, the Company agrees to announce the impending release or waiver by a press release substantially in the form of Exhibit C hereto through a major news service at least two business days before the effective date of the release or waiver.

(i) *Use of Proceeds.* The Company intends to apply the net proceeds from the sale of the Shares as described in each of the Registration Statement, the Pricing Disclosure Package and the Prospectus under the heading “Use of Proceeds”.

(j) *No Stabilization.* The Company will not take, directly or indirectly, without giving effect to activities by the Underwriters, any action designed to or that would reasonably be expected to cause or result in any stabilization or manipulation of the price of the Stock.

(k) *Exchange Listing.* The Company will use its best efforts to list, subject to notice of issuance, the Shares on the Exchange.

(l) *Reports.* For a period of one year from the date of this Agreement, so long as the Company is subject to the reporting requirements of either Section 13 or Section 15(d) of the Exchange Act, the Company will furnish to the Representatives, as soon as commercially reasonable after they are available, copies of all reports or other communications (financial or other) furnished to holders of the Shares, and copies of any reports and financial statements furnished to or filed with the Commission or any national securities exchange or automatic quotation system; provided the Company will be deemed to have furnished such reports and financial statements to the Representatives to the extent they are filed on the Commission’s Electronic Data Gathering, Analysis, and Retrieval system or any successor system.

(m) *Record Retention.* The Company will, pursuant to reasonable procedures developed in good faith, retain copies of each Issuer Free Writing Prospectus that is not filed with the Commission in accordance with Rule 433 under the Securities Act.

(n) *Filings.* The Company will file with the Commission such reports as may be required by Rule 463 under the Securities Act.

(o) *Emerging Growth Company.* The Company will promptly notify the Representatives if the Company ceases to be an Emerging Growth Company at any time prior to the later of (i) completion of the distribution of Shares within the meaning of the Securities Act and (ii) completion of the 180-day restricted period referred to in Section 6(h) hereof.

(p) *FIRPTA Certificate.* The Company will deliver to each Underwriter, on or before the Closing Date, (i) a certificate with respect to the Company’s status as a “United States real property holding corporation,” dated not more than thirty (30) days prior to the Closing Date, as described in Treasury Regulations Sections 1.897-2(h) and 1.1445-2(c)(3), and (ii) proof of delivery to the Internal Revenue Service of the required notice, as described in Treasury Regulations Section 1.897-2(h)(2).

7. Further Agreements of the Selling Stockholders. Each of the Selling Stockholders covenants and agrees with each Underwriter that:

(a) *Lock-Up Agreements.* Such Selling Stockholder has duly executed and delivered to the Representatives a lock-up agreement substantially in the form of Exhibit D hereto.

(b) *No Stabilization.* Such Selling Stockholder will not take, directly or indirectly, any action designed to or that would reasonably be expected to cause or result in any stabilization or manipulation of the price of the Stock.

(c) *Tax Form.* Such Selling Stockholder will deliver to the Representatives prior to or at the Closing Date a properly completed and executed United States Treasury Department Form W-9 (or other applicable form or statement specified by the Treasury Department regulations in lieu thereof) in order to facilitate the Underwriters' documentation of their compliance with the reporting and withholding provisions of the Code with respect to the transactions herein contemplated.

(d) *Use of Proceeds.* It will not knowingly directly or indirectly use the proceeds of the offering of the Shares hereunder, or knowingly lend, contribute or otherwise make available such proceeds to a subsidiary, joint venture partner or other person or entity (i) to fund or facilitate any activities of or business with any person that, at the time of such funding or facilitation, is the subject or target of Sanctions, (ii) to fund or facilitate any activities of or business in any Sanctioned Country, (iii) in any other manner that will result in a violation by any person (including any person participating in the transaction, whether as underwriter, advisor, investor or otherwise) of Sanctions or (iv) in furtherance of an offer, payment, promise to pay, or authorization of payment or giving of money, or anything else of value, to any person in violation of applicable anti-corruption laws.

8. Certain Agreements of the Underwriters. Each Underwriter hereby represents and agrees that:

(a) It has not and will not use, authorize use of, refer to or participate in the planning for use of, any "free writing prospectus", as defined in Rule 405 under the Securities Act (which term includes use of any written information furnished to the Commission by the Company and not incorporated by reference into the Registration Statement and any press release issued by the Company) other than (i) a free writing prospectus that contains no "issuer information" (as defined in Rule 433(h)(2) under the Securities Act) that was not included (including through incorporation by reference) in the Preliminary Prospectus or a previously filed Issuer Free Writing Prospectus, (ii) any Issuer Free Writing Prospectus listed on Annex A or prepared pursuant to Section 3(c) or Section 4(c) above (including any electronic road show approved in advance by the Company), or (iii) any free writing prospectus prepared by such underwriter and approved by the Company in advance in writing (each such free writing prospectus referred to in clauses (i) or (iii), an "Underwriter Free Writing Prospectus").

(b) It has not used, and will not use without the prior written consent of the Company, any free writing prospectus that contains the final terms of the Shares unless such terms have previously been included in a free writing prospectus filed with the Commission; *provided* that Underwriters may use a term sheet substantially in the form of Annex C hereto without the consent of the Company; *provided further* that any Underwriter using such term sheet shall notify the Company, and provide a copy of such term sheet to the Company, prior to, or substantially concurrently with, the first use of such term sheet.

(c) It is not subject to any pending proceeding under Section 8A of the Securities Act with respect to the offering (and will promptly notify the Company and the Selling Stockholders if any such proceeding against it is initiated during the Prospectus Delivery Period).

9. Conditions of Underwriters' Obligations. The obligation of each Underwriter to purchase the Underwritten Shares on the Closing Date or the Option Shares on the Additional Closing Date, as the case may be, as provided herein is subject to the performance by the Company and each of the Selling Stockholders of their respective covenants and other obligations hereunder and to the following additional conditions:

(a) *Registration Compliance; No Stop Order.* No order suspending the effectiveness of the Registration Statement shall be in effect, and no proceeding for such purpose or pursuant to Section 8A under the Securities Act shall be pending before or threatened by the Commission; the Prospectus and each Issuer Free Writing Prospectus shall have been timely filed with the Commission under the Securities Act (in the case of an Issuer Free Writing Prospectus, to the extent required by Rule 433 under the Securities Act) and in accordance with Section 6(a) hereof; and all requests by the Commission for additional information shall have been complied with to the reasonable satisfaction of the Representatives.

(b) *Representations and Warranties.* The respective representations and warranties of the Company and the Selling Stockholders contained herein shall be true and correct on the date hereof and on and as of the Closing Date or the Additional Closing Date, as the case may be; and the statements of the Company and its officers and of each of the Selling Stockholders made in any certificates delivered pursuant to this Agreement shall be true and correct on and as of the Closing Date or the Additional Closing Date, as the case may be.

(c) *No Material Adverse Change.* No event or condition of a type described in Section 3(h) hereof shall have occurred or shall exist, which event or condition is not described in the Pricing Disclosure Package (excluding any amendment or supplement thereto) and the Prospectus (excluding any amendment or supplement thereto) and the effect of which in the judgment of the Representatives makes it impracticable or inadvisable to proceed with the offering, sale or delivery of the Shares on the Closing Date or the Additional Closing Date, as the case may be, on the terms and in the manner contemplated by this Agreement, the Pricing Disclosure Package and the Prospectus.

(d) *Officer's Certificate.* The Representatives shall have received on and as of the Closing Date or the Additional Closing Date, as the case may be, (x) a certificate, on behalf of the Company, of the chief financial officer or chief accounting officer of the Company and one additional senior executive officer of the Company who is satisfactory to the Representatives (i) confirming that such officers have carefully reviewed the Registration Statement, the Pricing Disclosure Package and the Prospectus and, to the knowledge of such officers, the representations of the Company set forth in Sections 3(b) and 3(d) hereof are true and correct, (ii) confirming that the other representations and warranties of the Company in this Agreement are true and correct and that the Company has complied with all agreements and satisfied all conditions on its part to be performed or satisfied hereunder at or prior to the Closing Date or the Additional Closing Date, as the case may be, and (iii) to the effect set forth in paragraphs (a) and (c) above and (y) a certificate of each of the Selling Stockholders, in form and substance reasonably satisfactory to the Representatives, (A) confirming that the representations of such Selling Stockholder set forth in Sections 4(e), 4(f) and 4(g) hereof are true and correct and (B) confirming that the other representations and warranties of such Selling Stockholder in this agreement are true and correct and that the such Selling Stockholder has complied with all agreements and satisfied all conditions on its part to be performed or satisfied hereunder at or prior to such Closing Date.

(e) *Comfort Letters.* (i) On the date of this Agreement and on the Closing Date or the Additional Closing Date, as the case may be, Ernst & Young LLP shall have furnished to the Representatives, at the request of the Company, letters, dated the respective dates of delivery thereof and addressed to the Underwriters, in form and substance reasonably satisfactory to the Representatives, containing statements and information of the type customarily included in accountants' "comfort letters" to underwriters with respect to the financial statements and certain financial information contained in each of the Registration Statement, the Pricing Disclosure Package and the Prospectus; provided, that the letter delivered on the Closing Date or the Additional Closing Date, as the case may be, shall use a "cut-off" date no more than three business days prior to such Closing Date or such Additional Closing Date, as the case may be. (ii) On the date of this Agreement and on the Closing Date or the Additional Closing Date, as the case may be, the Company shall have furnished to the Representatives a certificate, dated the respective dates of delivery thereof and addressed to the Underwriters, of its chief financial officer with respect to certain financial data contained in the Pricing Disclosure Package and the Prospectus providing "management comfort" with respect to such information, in form and substance reasonably satisfactory to the Representatives.

(f) *Opinion and 10b-5 Statement of Counsel for the Company.* Lowenstein Sandler LLP, counsel for the Company, shall have furnished to the Representatives, at the request of the Company, their written opinion and 10b-5 statement, dated the Closing Date or the Additional Closing Date, as the case may be, and addressed to the Underwriters, in form and substance reasonably satisfactory to the Representatives.

(g) *Opinion and 10b-5 Statement of Counsel for the Selling Stockholders.* Jaffe Raitt Heuer & Weiss, P.C., counsel for the Selling Stockholders, shall have furnished to the Representative, at the request of the Selling Stockholders, their written opinion and 10b-5 statement, dated the Closing Date, and addressed to the Underwriters, in form and substance reasonably satisfactory to the Representative.

(h) *Opinion and 10b-5 Statement of Counsel for the Underwriters.* The Representatives shall have received on and as of the Closing Date or the Additional Closing Date, as the case may be, an opinion and 10b-5 statement of Goodwin Procter LLP, counsel for the Underwriters, with respect to such matters as the Representatives may reasonably request, and such counsel shall have received such documents and information as they may reasonably request to enable them to pass upon such matters.

(i) *No Legal Impediment to Issuance and/or Sale.* No action shall have been taken and no statute, rule, regulation or order shall have been enacted, adopted or issued by any federal, state or foreign governmental or regulatory authority that would, as of the Closing Date or the Additional Closing Date, as the case may be, prevent the issuance or sale of the Shares by the Company or the sale of the Shares by the Selling Stockholders; and no injunction or order of any federal, state or foreign court shall have been issued that would, as of the Closing Date or the Additional Closing Date, as the case may be, prevent the issuance or sale of the Shares by the Company or the sale of the Shares by the Selling Stockholders.

(j) *Good Standing.* The Representatives shall have received on and as of the Closing Date or the Additional Closing Date, as the case may be, satisfactory evidence of the good standing of the Company and its subsidiaries in their respective jurisdictions of organization and their good standing in such other jurisdictions as the Representatives may reasonably request, in each case in writing or any standard form of telecommunication from the appropriate governmental authorities of such jurisdictions.

(k) *Exchange Listing.* The Shares to be delivered on the Closing Date or the Additional Closing Date, as the case may be, shall have been approved for listing on the Exchange, subject to official notice of issuance.

(l) *Lock-up Agreements.* The “lock-up” agreements, each substantially in the form of Exhibit D hereto, between you and certain shareholders, officers and directors of the Company relating to sales and certain other dispositions of shares of Stock or certain other securities, delivered to you on or before the date hereof, shall be in full force and effect on the Closing Date or the Additional Closing Date, as the case may be.



(m) *Principal Financial Officer Certificate.* The Company shall have furnished to the Representatives a certificate, dated as of the Closing Date or the Additional Closing Date, of its Principal Financial Officer, in form and substance reasonably satisfactory to counsel for the Underwriters and customary for the type of offering contemplated by this Agreement.

(n) *Additional Documents.* On or prior to the Closing Date or the Additional Closing Date, as the case may be, the Company and the Selling Stockholders shall have furnished to the Representatives such further certificates and documents as the Representatives may reasonably request.

All opinions, letters, certificates and evidence mentioned above or elsewhere in this Agreement shall be deemed to be in compliance with the provisions hereof only if they are in form and substance reasonably satisfactory to counsel for the Underwriters.

10. Indemnification and Contribution.

(a) *Indemnification of the Underwriters by the Company.* The Company agrees to indemnify and hold harmless each Underwriter, its affiliates, directors and officers and each person, if any, who controls such Underwriter within the meaning of Section 15 of the Securities Act or Section 20 of the Exchange Act, from and against any and all losses, claims, damages and liabilities (including, without limitation, out-of-pocket legal fees and other expenses reasonably incurred in connection with any suit, action or proceeding or any claim asserted, as such fees and expenses are incurred), joint or several, that arise out of, or are based upon, (i) any untrue statement or alleged untrue statement of a material fact contained in the Registration Statement or caused by any omission or alleged omission to state therein a material fact required to be stated therein or necessary in order to make the statements therein, not misleading, or (ii) any untrue statement or alleged untrue statement of a material fact contained in the Prospectus (or any amendment or supplement thereto), any Issuer Free Writing Prospectus, any "issuer information" filed or required to be filed pursuant to Rule 433(d) under the Securities Act, any Written Testing-the-Waters Communication, any road show as defined in Rule 433(h) under the Securities Act (a "road show") or any Pricing Disclosure Package (including any Pricing Disclosure Package that has subsequently been amended), or caused by any omission or alleged omission to state therein a material fact necessary in order to make the statements therein, in light of the circumstances under which they were made, not misleading, in each case except insofar as such losses, claims, damages or liabilities arise out of, or are based upon, any untrue statement or omission or alleged untrue statement or omission made in reliance upon and in conformity with any information relating to any Underwriter furnished to the Company in writing by such Underwriter through the Representatives expressly for use therein, it being understood and agreed that the only such information furnished by any Underwriter consists of the information described as such in subsection (c) below and (ii) any information relating to any Selling Stockholder other than an executive officer of the Company furnished to the Company in writing by and on behalf of such Selling Stockholder expressly for use therein, it being understood and agreed that the only such information furnished by any Selling Stockholder consists of the Selling Stockholder Information.

The Company also agrees to indemnify and hold harmless, Deutsche Bank Securities Inc., its affiliates, directors and officers and each person, if any, who controls Deutsche Bank Securities Inc. within the meaning of Section 15 of the Securities Act or Section 20 of the Exchange Act, from and against any and all losses, claims, damages and liabilities incurred as a result of Deutsche Bank Securities Inc.'s participation as a "qualified independent underwriter" within the meaning of FINRA Rule 5121 in connection with the offering of the Shares.

(b) *Indemnification of the Underwriters by the Selling Stockholders.* Each of the Selling Stockholders severally and not jointly in proportion to the number of Shares to be sold by such Selling Stockholder hereunder agrees to indemnify and hold harmless each Underwriter, its affiliates, directors and officers and each person, if any, who controls such Underwriter within the meaning of Section 15 of the Securities Act or Section 20 of the Exchange Act to the same extent as the indemnity set forth in paragraph (a) above, in each case only insofar as such losses, claims, damages or liabilities arise out of, or are based upon, any untrue statement or omission or alleged untrue statement or omission made in reliance upon and in conformity with the Selling Stockholder Information furnished by such Selling Stockholder. The liability of each Selling Stockholder under the indemnity and contribution agreements contained in this Section 10 shall be limited to an amount equal to (i) the number of Shares sold by such Selling Stockholder under this Agreement multiplied by (ii) the Public Offering Price (minus related underwriting discounts and commissions) (the “Selling Stockholder Net Proceeds”).

Each of the Selling Stockholders severally and not jointly in proportion to the number of Shares to be sold by such Selling Stockholder hereunder also agrees to indemnify and hold harmless Deutsche Bank Securities Inc., its affiliates, directors and officers and each person, if any, who controls Deutsche Bank Securities Inc. within the meaning of Section 15 of the Securities Act or Section 20 of the Exchange Act, from and against any and all losses, claims, damages and liabilities incurred as a result of Deutsche Bank Securities Inc.’s participation as a “qualified independent underwriter” within the meaning of FINRA Rule 5121 in connection with the offering of the Shares.

(c) *Indemnification of the Company and the Selling Stockholders.* Each Underwriter agrees, severally and not jointly, to indemnify and hold harmless the Company, its directors, its officers who signed the Registration Statement and each person, if any, who controls the Company within the meaning of Section 15 of the Securities Act or Section 20 of the Exchange Act and each of the Selling Stockholders to the same extent as the indemnity set forth in paragraph (a) above, but only with respect to any losses, claims, damages or liabilities that arise out of, or are based upon, any untrue statement or omission or alleged untrue statement or omission made in reliance upon and in conformity with any information relating to such Underwriter furnished to the Company in writing by such Underwriter through the Representatives expressly for use in the Registration Statement, the Prospectus (or any amendment or supplement thereto), any Issuer Free Writing Prospectus, any Written Testing-the-Waters Communication, any road show or any Pricing Disclosure Package (including any Pricing Disclosure Package that has subsequently been amended), it being understood and agreed upon that the only such information furnished by any Underwriter consists of the following information in the Prospectus furnished on behalf of each Underwriter: the concession and reallowance figures appearing in the [●] paragraph under the caption “Underwriting”, the information contained in the [●] paragraph relating to stabilizing transactions under the caption “Underwriting”[, and the following information in the Issuer Free Writing Prospectus dated [●], 2017].

(d) *Notice and Procedures.* If any suit, action, proceeding (including any governmental or regulatory investigation), claim or demand shall be brought or asserted against any person in respect of which indemnification may be sought pursuant to the preceding paragraphs of this Section 10, such person (the “Indemnified Person”) shall promptly notify the person against whom such indemnification may be sought (the “Indemnifying Person”) in writing; provided that the failure to notify the Indemnifying Person shall not relieve it from any liability that it may have under the preceding paragraphs of this Section 10 except to the extent that it has been materially prejudiced (through the forfeiture of substantive rights or defenses) by such failure; and provided further that the failure to notify the Indemnifying Person shall not relieve it from any liability that it may have to an Indemnified Person

otherwise than under the preceding paragraphs of this Section 10. If any such proceeding shall be brought or asserted against an Indemnified Person and it shall have notified the Indemnifying Person thereof, the Indemnifying Person shall be entitled to participate therein, and to the extent it wishes, jointly with any other indemnifying party similarly notified, to assume the defense thereof, with counsel reasonably satisfactory to the Indemnified Person (who shall not, without the consent of the Indemnified Person, be counsel to the Indemnifying Person) to represent the Indemnified Person in such proceeding and shall pay the reasonable fees and expenses of such counsel related to such proceeding promptly and, after notice from the Indemnifying Person to such Indemnified Person of its election so to assume the defense thereof, the Indemnifying Person shall not be liable to such Indemnified Person under the preceding paragraphs of this Section 10, as the case may be, for any legal expenses of other counsel or any other expenses, in each case subsequently incurred by such Indemnified Person, in connection with the defense thereof other than reasonable costs of investigation. In any such proceeding, any Indemnified Person shall have the right to retain its own counsel, but the reasonably incurred fees and expenses of such counsel shall be at the expense of such Indemnified Person unless (i) the Indemnifying Person and the Indemnified Person shall have mutually agreed to the contrary; (ii) the Indemnifying Person has failed within a reasonable time to retain counsel reasonably satisfactory to the Indemnified Person; (iii) the Indemnified Person shall have reasonably concluded that there may be legal defenses available to it that are different from or in addition to those available to the Indemnifying Person; or (iv) the named parties in any such proceeding (including any impleaded parties) include both the Indemnifying Person and the Indemnified Person and representation of both parties by the same counsel would be inappropriate due to actual or potential differing interest between them. It is understood and agreed that the Indemnifying Person shall not, in connection with any proceeding or related proceedings in the same jurisdiction, be liable for the fees and expenses of more than one separate firm (in addition to any local counsel) for all Indemnified Persons, and that all such fees and expenses shall be paid or reimbursed promptly. Any such separate firm for any Underwriter, its affiliates, directors and officers and any control persons of such Underwriter shall be designated in writing by the Representatives and any such separate firm for the Company, its directors, its officers who signed the Registration Statement and any control persons of the Company shall be designated in writing by the Company and any such separate firm for the Selling Stockholders shall be designated in writing by the Attorneys-in-Fact or any one of them. The Indemnifying Person shall not be liable for any settlement of any proceeding effected without its written consent (which shall not be unreasonably withheld, delayed or conditioned), but if settled with such consent or if there be a final judgment for the plaintiff, the Indemnifying Person agrees to indemnify each Indemnified Person from and against any loss or liability by reason of such settlement or judgment. No Indemnifying Person shall, without the written consent of the Indemnified Person (which shall not be unreasonably withheld, delayed or conditioned), effect any settlement of any pending or threatened proceeding in respect of which any Indemnified Person is or could have been a party and indemnification could have been sought hereunder by such Indemnified Person, unless such settlement (x) includes an unconditional release of such Indemnified Person, in form and substance reasonably satisfactory to such Indemnified Person, from all liability on claims that are the subject matter of such proceeding and (y) does not include any statement as to or any admission of fault, culpability or a failure to act by or on behalf of any Indemnified Person.

(e) *Contribution.* If the indemnification provided for in paragraphs (a), (b) and (c) above is unavailable to an Indemnified Person or insufficient in respect of any losses, claims, damages or liabilities referred to therein, then each Indemnifying Person under such paragraph, in lieu of indemnifying such Indemnified Person thereunder, shall contribute to the amount paid or payable by such Indemnified Person as a result of such losses, claims, damages or liabilities (i) in such proportion as is appropriate to reflect the relative benefits received by the Company and the Selling Stockholders, on the one hand, and the Underwriters or Deutsche Bank Securities Inc. in its capacity as a “qualified independent underwriter”, as the case may be, on the other, from the offering of the Shares or (ii) if the allocation provided by clause (i) is not permitted by applicable law, in such proportion as is appropriate to reflect not only the relative benefits referred to in clause (i) but also the relative fault of the Company and the

Selling Stockholders, on the one hand, and the Underwriters or Deutsche Bank Securities Inc. in its capacity as a “qualified independent underwriter”, as the case may be, on the other, in connection with the statements or omissions that resulted in such losses, claims, damages or liabilities, as well as any other relevant equitable considerations. The relative benefits received by the Company and the Selling Stockholders, on the one hand, and the Underwriters or Deutsche Bank Securities Inc. in its capacity as a “qualified independent underwriter”, as the case may be, on the other, shall be deemed to be in the same respective proportions as the net proceeds (after deducting underwriting discounts and commission but before deducting expenses) received by the Company and the Selling Stockholders from the sale of the Shares and the total underwriting discounts and commissions received by the Underwriters in connection therewith, in each case as set forth in the table on the cover of the Prospectus, or any fee to be received by Deutsche Bank Securities Inc. in its capacity as a “qualified independent underwriter”, as the case may be, bear to the aggregate offering price of the Shares. The relative fault of the Company and the Selling Stockholders, on the one hand, and the Underwriters or Deutsche Bank Securities Inc. in its capacity as a “qualified independent underwriter”, as the case may be, on the other, shall be determined by reference to, among other things, whether the untrue or alleged untrue statement of a material fact or the omission or alleged omission to state a material fact relates to information supplied by the Company and the Selling Stockholders or by the Underwriters or Deutsche Bank Securities Inc. in its capacity as a “qualified independent underwriter”, as the case may be, and the parties’ relative intent, knowledge, access to information and opportunity to correct or prevent such statement or omission.

(f) *Limitation on Liability.* The Company, the Selling Stockholders and the Underwriters agree that it would not be just and equitable if contribution pursuant to paragraph (e) above were determined by pro rata allocation (even if the Selling Stockholders or the Underwriters were treated as one entity for such purpose) or by any other method of allocation that does not take account of the equitable considerations referred to in paragraph (e) above. The amount paid or payable by an Indemnified Person as a result of the losses, claims, damages and liabilities referred to in paragraph (e) above shall be deemed to include, subject to the limitations set forth above, any legal or other expenses reasonably incurred by such Indemnified Person in connection with any such action or claim. Notwithstanding the provisions of paragraphs (e) and (f), in no event shall (i) an Underwriter be required to contribute any amount in excess of the amount by which the total underwriting discounts and commissions received by such Underwriter with respect to the offering of the Shares exceeds the amount of any damages that such Underwriter has otherwise been required to pay by reason of such untrue or alleged untrue statement or omission or alleged omission or (ii) the aggregate liability of a Selling Stockholder under Section 10(b) and Section 10(e) exceed the limit set forth in Section 10(b) above. No person guilty of fraudulent misrepresentation (within the meaning of Section 11(f) of the Securities Act) shall be entitled to contribution from any person who was not guilty of such fraudulent misrepresentation. The Underwriters’ obligations to contribute pursuant to paragraphs (e) and (f) are several in proportion to their respective purchase obligations hereunder and not joint.

(g) *Non-Exclusive Remedies.* The remedies provided for in this Section 10 are not exclusive and shall not limit any rights or remedies which may otherwise be available to any Indemnified Person at law or in equity.

11. Effectiveness of Agreement. This Agreement shall become effective upon the execution and delivery hereof by the parties.

12. Termination. This Agreement may be terminated in the absolute discretion of the Representatives, by notice to the Company and the Selling Stockholders, if after the execution and delivery of this Agreement and on or prior to the Closing Date or, in the case of the Option Shares, prior to the Additional Closing Date (i) trading generally shall have been suspended or materially limited on or by any of the New York Stock Exchange or The Nasdaq Stock Market; (ii) trading of any securities

issued or guaranteed by the Company shall have been suspended on any exchange or in any over-the-counter market; (iii) a general moratorium on commercial banking activities shall have been declared by federal or New York State authorities; or (iv) there shall have occurred any outbreak or escalation of hostilities or any change in financial markets or any calamity or crisis, either within or outside the United States, that, in the judgment of the Representatives, is material and adverse and makes it impracticable or inadvisable to proceed with the offering, sale or delivery of the Shares on the Closing Date or the Additional Closing Date, as the case may be, on the terms and in the manner contemplated by this Agreement, the Pricing Disclosure Package and the Prospectus.

13. Defaulting Underwriter.

(a) If, on the Closing Date or the Additional Closing Date, as the case may be, any Underwriter defaults on its obligation to purchase the Shares that it has agreed to purchase hereunder on such date, the non-defaulting Underwriters may in their discretion arrange for the purchase of such Shares by other persons satisfactory to the Company and the Selling Stockholders on the terms contained in this Agreement. If, within 36 hours after any such default by any Underwriter, the non-defaulting Underwriters do not arrange for the purchase of such Shares, then the Company and the Selling Stockholders shall be entitled to a further period of 36 hours within which to procure other persons satisfactory to the non-defaulting Underwriters to purchase such Shares on such terms. If other persons become obligated or agree to purchase the Shares of a defaulting Underwriter, either the non-defaulting Underwriters or the Company and the Selling Stockholders may postpone the Closing Date or the Additional Closing Date, as the case may be, for up to five full business days in order to effect any changes that in the opinion of counsel for the Company, counsel for the Selling Stockholders or counsel for the Underwriters may be necessary in the Registration Statement and the Prospectus or in any other document or arrangement, and the Company agrees to promptly prepare any amendment or supplement to the Registration Statement and the Prospectus that effects any such changes. As used in this Agreement, the term "Underwriter" includes, for all purposes of this Agreement unless the context otherwise requires, any person not listed in Schedule 1 hereto that, pursuant to this Section 13, purchases Shares that a defaulting Underwriter agreed but failed to purchase.

(b) If, after giving effect to any arrangements for the purchase of the Shares of a defaulting Underwriter or Underwriters by the non-defaulting Underwriters, the Company and the Selling Stockholders as provided in paragraph (a) above, the aggregate number of Shares that remain unpurchased on the Closing Date or the Additional Closing Date, as the case may be, does not exceed one-eleventh of the aggregate number of Shares to be purchased on such date, then the Company and the Selling Stockholders shall have the right to require each non-defaulting Underwriter to purchase the number of Shares that such Underwriter agreed to purchase hereunder on such date plus such Underwriter's pro rata share (based on the number of Shares that such Underwriter agreed to purchase on such date) of the Shares of such defaulting Underwriter or Underwriters for which such arrangements have not been made.

(c) If, after giving effect to any arrangements for the purchase of the Shares of a defaulting Underwriter or Underwriters by the non-defaulting Underwriters, the Company and the Selling Stockholders as provided in paragraph (a) above, the aggregate number of Shares that remain unpurchased on the Closing Date or the Additional Closing Date, as the case may be, exceeds one-eleventh of the aggregate amount of Shares to be purchased on such date, or if the Company and the Selling Stockholders shall not exercise the right described in paragraph (b) above, then this Agreement or, with respect to any Additional Closing Date, the obligation of the Underwriters to purchase Shares on the Additional Closing Date, as the case may be, shall terminate without liability on the part of the non-defaulting Underwriters. Any termination of this Agreement pursuant to this Section 13 shall be without liability on the part of the Company, except that the Company and the Selling Stockholders will continue to be liable for the payment of expenses as set forth in Section 14 hereof and except that the provisions of Section 10 hereof shall not terminate and shall remain in effect.

(d) Nothing contained herein shall relieve a defaulting Underwriter of any liability it may have to the Company, the Selling Stockholders or any non-defaulting Underwriter for damages caused by its default.

14. Payment of Expenses.

(a) Whether or not the transactions contemplated by this Agreement are consummated or this Agreement is terminated, the Company will pay or cause to be paid all costs and expenses incident to the performance of its obligations hereunder, including without limitation, (i) the costs incident to the authorization, issuance, sale, preparation and delivery of the Shares and any taxes payable in that connection; (ii) the costs incident to the preparation, printing and filing under the Securities Act of the Registration Statement, the Preliminary Prospectus, any Issuer Free Writing Prospectus, any Pricing Disclosure Package and the Prospectus (including all exhibits, amendments and supplements thereto) and the distribution thereof; (iii) the fees and expenses of the Company's counsel and independent accountants; (iv) the fees and expenses incurred in connection with the registration or qualification and determination of eligibility for investment of the Shares under the laws of such jurisdictions as the Representatives may designate and, if required, the preparation, printing and distribution of a Blue Sky Memorandum (including the reasonably incurred fees and expenses of counsel for the Underwriters related thereto) in an amount not to exceed [\$10,000] (excluding filing fees); (v) the cost of preparing stock certificates; (vi) the costs and charges of any transfer agent and any registrar; (vii) all expenses and application fees incurred in connection with any filing with, and clearance of the offering by, FINRA (including the related reasonable fees and expenses of Deutsche Bank Securities Inc. acting as "qualified independent underwriter" within the meaning of the aforementioned FINRA Rule 5121) in an amount not to exceed [\$30,000] (excluding filing fees); (viii) all expenses and application fees related to the listing of the Shares on the Exchange; and (ix) all of the travel and lodging expenses of the Company or any of its employees incurred by them in connection with any "road show" presentation to potential investors; provided, however, that the Underwriters will pay all of the travel, lodging and other expenses of the Underwriters or any of their employees incurred by them in connection with the "road show", and provided, further, that the Company and the Underwriters will each pay 50% of all other expenses incurred in connection with the "road show", including 50% of the cost of any aircraft chartered in connection with such road show. The provisions of this Section shall not supersede or otherwise affect any agreement that the Company and the Selling Stockholders may otherwise have for the allocation of such expenses among themselves.

(b) If (i) this Agreement is terminated pursuant to clause (ii) of Section 12, (ii) the Company for any reason fails to tender the Shares required to be tendered by it or on its behalf pursuant to this Agreement for delivery to the Underwriters other than as a result of a termination pursuant to clause (i), (iii) or (iv) of Section 12 or (iii) the Underwriters decline to purchase the Shares for any reason permitted under this Agreement (other than as a result of a termination pursuant to clause (i), (iii) or (iv) of Section 12 or as set forth in Section 13), the Company agrees to reimburse the Underwriters for all out-of-pocket costs and expenses (including the reasonable and documented fees and expenses of their counsel) reasonably incurred and documented by the Underwriters in connection with this Agreement and the offering contemplated hereby. If any Selling Stockholder for any reason defaults on its obligation to tender the Shares required to be tendered by it or on its behalf pursuant to this Agreement for delivery to the Underwriters, such Selling Stockholder agrees to reimburse the Underwriters for all out-of-pocket costs and expenses (including the reasonable and documented fees and expenses of their counsel) reasonably incurred and documented by the Underwriters in making preparations for the purchase, sale and delivery of the Shares not so delivered by such Selling Stockholder. For the avoidance of doubt, it is understood that neither the Company nor the Selling Stockholders shall pay or reimburse any costs, fees or expenses incurred by any Underwriter that defaults on its obligations to purchase the Shares.

15. Persons Entitled to Benefit of Agreement. This Agreement shall inure to the benefit of and be binding upon the parties hereto and their respective successors and the officers and directors and any controlling persons referred to herein, and the affiliates of each Underwriter referred to in Section 10 hereof. Nothing in this Agreement is intended or shall be construed to give any other person any legal or equitable right, remedy or claim under or in respect of this Agreement or any provision contained herein. No purchaser of Shares from any Underwriter shall be deemed to be a successor merely by reason of such purchase.

16. Survival. The respective indemnities, rights of contribution, representations, warranties and agreements of the Company, the Selling Stockholders and the Underwriters contained in this Agreement or made by or on behalf of the Company, the Selling Stockholders or the Underwriters pursuant to this Agreement or any certificate delivered pursuant hereto shall survive the delivery of and payment for the Shares and shall remain in full force and effect, regardless of any termination of this Agreement or any investigation made by or on behalf of the Company, the Selling Stockholders or the Underwriters.

17. Certain Defined Terms. For purposes of this Agreement, (a) except where otherwise expressly provided, the term "affiliate" has the meaning set forth in Rule 405 under the Securities Act; (b) the term "business day" means any day other than a day on which banks are permitted or required to be closed in New York City; and (c) the term "subsidiary" has the meaning set forth in Rule 405 under the Securities Act.

18. Compliance with USA Patriot Act. In accordance with the requirements of the USA Patriot Act (Title III of Pub. L. 107-56 (signed into law October 26, 2001)), the Underwriters are required to obtain, verify and record information that identifies their respective clients, including the Company and the Selling Stockholders, which information may include the name and address of their respective clients, as well as other information that will allow the Underwriters to properly identify their respective clients.

19. Miscellaneous.

(a) Notices. All notices and other communications hereunder shall be in writing and shall be deemed to have been duly given if mailed or transmitted and confirmed by any standard form of telecommunication. Notices to the Underwriters shall be given to the Representatives c/o J. P. Morgan Securities LLC, 383 Madison Avenue, New York, New York 10179 (fax: (212) 622-8358); Attention: Equity Syndicate Desk and RBC Capital Markets, LLC, Three World Financial Center, 200 Vesey Street, New York, NY 10281, Attention: Syndicate Director, Facsimile: (212)428-6200. Notices to the Company shall be given to it at Altair Engineering Inc., 1820 E. Big Beaver Road, Troy, Michigan 48083, Facsimile (248) 614-2411; Attention: Howard Morof, Chief Financial Officer. Notices to the Selling Stockholders shall be given to the Attorneys-in-Fact at Jaffe, Raitt, Heuer and Weiss, P.C., 27777 Franklin Road, Suite 2500, Southfield, MI, 48034, (Fax:248-351-3082); Attention: Peter Sugar; psugar@jaffelaw.com

(b) Governing Law. This Agreement and any claim, controversy or dispute arising under or related to this Agreement shall be governed by and construed in accordance with the laws of the State of New York applicable to agreements made and to be performed in such state.

(c) Waiver of Jury Trial. Each of the parties hereto hereby waives any right to trial by jury in any suit or proceeding arising out of or relating to this Agreement.

(d) *Counterparts.* This Agreement may be signed in counterparts (which may include counterparts delivered by any standard form of telecommunication), each of which shall be an original and all of which together shall constitute one and the same instrument.

(e) *Amendments or Waivers.* No amendment or waiver of any provision of this Agreement, nor any consent or approval to any departure therefrom, shall in any event be effective unless the same shall be in writing and signed by the parties hereto.

(f) *Headings.* The headings herein are included for convenience of reference only and are not intended to be part of, or to affect the meaning or interpretation of, this Agreement.



If the foregoing is in accordance with your understanding, please indicate your acceptance of this Agreement by signing in the space provided below.

Very truly yours,

ALTAIR ENGINEERING INC.

By: \_\_\_\_\_  
Name:  
Title:

SELLING STOCKHOLDERS

By: \_\_\_\_\_  
Name:  
Title:

By: \_\_\_\_\_  
Name:  
Title:

As Attorneys-in-Fact acting on behalf of each of the Selling Stockholders named in Schedule 2 to this Agreement.

Accepted: As of the date first written above

J. P. MORGAN SECURITIES LLC

By: \_\_\_\_\_  
Authorized Signatory

RBC CAPITAL MARKETS, LLC

By: \_\_\_\_\_  
Authorized Signatory

For themselves and on behalf of the several Underwriters listed  
in Schedule 1 hereto.

<u>Underwriter</u>	<u>Number of Shares</u>
J. P. Morgan Securities LLC	
RBC Capital Markets, LLC	
Deutsche Bank Securities Inc.	
William Blair & Company, L.L.C.	
Canaccord Genuity Inc.	
Total	

Selling Stockholders:

Number of  
Underwritten Shares:

Attorneys-in-Fact

a. **Pricing Disclosure Package**

*[List each Issuer Free Writing Prospectus to be included in the Pricing Disclosure Package]*

b. **[Pricing Information Provided Orally by Underwriters]**

*[Set out key information included in script that will be used by Underwriters to confirm sales]*

Underwritten Shares: [●]

Option Shares: [●]

Public Offering Price per Share: [●]

Trade Date: [●]

Settlement Date: [●]

Underwritten Shares of Company: [●]

Underwritten Shares of Selling Stockholders: [●]

Written Testing-the-Waters Communications

[Investor Presentation dated [\_\_\_\_], 2017]

Altair Engineering Inc.

Pricing Term Sheet

[TBD]

EGC Testing the waters authorization (to be delivered by the issuer to J.P. Morgan in email or letter form).

In reliance on Section 5(d) of the Securities Act of 1933, as amended (the “Act”), Altair Engineering Inc. (the “Issuer”) hereby authorizes J.P. Morgan Securities LLC (“J.P. Morgan”) and its affiliates and their respective employees and RBC Capital Markets, LLC and its affiliates and their respective employees to engage on behalf of the Issuer in oral and written communications with potential investors that are “qualified institutional buyers”, as defined in Rule 144A under the Act, or institutions that are “accredited investors”, as defined in Regulation D under the Act, to determine whether such investors might have an interest in the Issuer’s contemplated initial public offering (“Testing the Waters Communications”). A “Written Testing the Waters Communication” means any Testing the Waters Communication that is a written communication within the meaning of Rule 405 under the Act. The Issuer represents that it is an “emerging growth company” as defined in Section 2(a)(19) of the Act (“Emerging Growth Company”) and agrees to promptly notify J.P. Morgan and RBC Capital Markets, LLC in writing if the Issuer hereafter ceases to be an Emerging Growth Company while this authorization is in effect. If at any time following the distribution of any Written Testing the Waters Communication there occurs an event or development as a result of which such Written Testing the Waters Communication included or would include an untrue statement of a material fact or omitted or would omit to state a material fact necessary in order to make the statements therein, in the light of the circumstances existing at that subsequent time, not misleading, the Issuer will promptly notify J.P. Morgan and RBC Capital Markets, LLC and will promptly amend or supplement, at its own expense, such Written Testing the Waters Communication to eliminate or correct such untrue statement or omission.

Nothing in this authorization is intended to limit or otherwise affect the ability of J.P. Morgan and its affiliates and their respective employees and RBC Capital Markets, LLC and its affiliates and their respective employees to engage in communications in which they could otherwise lawfully engage in the absence of this authorization, including, without limitation, any written communication containing only one or more of the statements specified under Rule 134(a) under the Act. This authorization shall remain in effect until the Issuer has provided to J.P. Morgan and RBC Capital Markets, LLC a written notice revoking this authorization. All notices as described herein shall be sent by email to the attention of Mark Hoh at Mark.Hoh@jpmorgan.com, with copies to Aravind Natarajan at aravind.natarajan@rbccm.com.



**[Form of Waiver of Lock-up]****J.P. MORGAN SECURITIES LLC****RBC CAPITAL MARKETS, LLC**Altair Engineering Inc.  
Public Offering of Common Stock

, 20\_\_

[Name and Address of  
Officer or Director  
Requesting Waiver]

Dear Mr./Ms. [Name]:

This letter is being delivered to you in connection with the offering by Altair Engineering Inc. (the "Company") of \_\_\_\_\_ shares of common stock, par value \$0.0001 per share (the "Common Stock"), of the Company and the lock-up letter dated \_\_\_\_\_, 20\_\_ (the "Lock-up Letter"), executed by you in connection with such offering, and your request for a [waiver] [release] dated \_\_\_\_\_, 20\_\_, with respect to \_\_\_\_\_ shares of [Class A]/[Class B] Common Stock (the "Shares").

J.P. Morgan Securities LLC and RBC Capital Markets, LLC hereby agree to [waive] [release] the transfer restrictions set forth in the Lock-up Letter, but only with respect to the Shares, effective \_\_\_\_\_, 20\_\_; provided, however, that such [waiver] [release] is conditioned on the Company announcing the impending [waiver] [release] by press release through a major news service at least two business days before effectiveness of such [waiver] [release]. This letter will serve as notice to the Company of the impending [waiver] [release].

Except as expressly [waived] [released] hereby, the Lock-up Letter shall remain in full force and effect.

---

Yours very truly,

**[Signature of J.P. Morgan Securities LLC Representative]**

**[Name of J.P. Morgan Securities LLC Representative]**

**[Signature of RBC Capital Markets, LLC Representative]**

**[Name of RBC Capital Markets, LLC Representative]**

cc: Altair Engineering Inc.

**[Form of Press Release]****Altair Engineering Inc.****[Date]**

Altair Engineering Inc. (the “Company”) announced today that J.P. Morgan Securities LLC and RBC Capital Markets, LLC, the lead book-running managers in the Company’s recent public sale of \_\_\_\_\_ shares of common stock, are [waiving] [releasing] a lock-up restriction with respect to \_\_\_\_\_ shares of the Company’s [Class A]/[Class B] common stock held by [certain officers or directors] [an officer or director] of the Company. The [waiver] [release] will take effect on \_\_\_\_\_, 20\_\_\_\_, and the shares may be sold on or after such date.

**This press release is not an offer for sale of the securities in the United States or in any other jurisdiction where such offer is prohibited, and such securities may not be offered or sold in the United States absent registration or an exemption from registration under the United States Securities Act of 1933, as amended.**

## FORM OF LOCK-UP AGREEMENT

\_\_\_\_\_, 20\_\_

J. P. MORGAN SECURITIES LLC  
RBC CAPITAL MARKETS, LLC

As Representatives of  
the several Underwriters listed in  
Schedule 1 to the Underwriting  
Agreement referred to below

c/o J. P. Morgan Securities LLC  
383 Madison Avenue  
New York, NY 10179

c/o RBC Capital Markets, LLC  
Three World Financial Center  
200 Vesey Street  
New York, NY 10281

Re: Altair Engineering Inc. — Initial Public Offering

Ladies and Gentlemen:

The undersigned understands that you, as Representatives of the several Underwriters, propose to enter into an underwriting agreement (the “Underwriting Agreement”) with Altair Engineering Inc., a Michigan corporation (the “Company”) and the Selling Stockholders listed on Schedule 2 of the Underwriting Agreement, providing for the public offering (the “Public Offering”) by the several Underwriters named in Schedule 1 to the Underwriting Agreement (the “Underwriters”), of Class A Common Stock of the Company (the “Securities”). Capitalized terms used herein and not otherwise defined shall have the meanings set forth in the Underwriting Agreement.

In consideration of the Underwriters’ agreement to purchase and make the Public Offering of the Securities, and for other good and valuable consideration receipt of which is hereby acknowledged, the undersigned hereby agrees that, without the prior written consent of J. P. Morgan Securities LLC and RBC Capital Markets, LLC on behalf of the Underwriters, the undersigned will not, during the period beginning on the date of this letter agreement (this “Letter Agreement”) and ending 180 days after the date of the prospectus relating to the Public Offering (the “Prospectus”) (such period, the “Restricted Period”), (1) offer, pledge, sell, contract to sell, sell any option or contract to purchase, purchase any option or contract to sell, grant any option, right or warrant to purchase, or otherwise transfer or dispose of, directly or indirectly, any shares of the Company’s Class A Common Stock, no par value per share (the “Class A Common Stock”), or Class B Common Stock, no par value per share (the “Class B Common Stock, and together with the Class A Common Stock, the “Common Stock”), or any securities convertible into or exercisable or exchangeable for Common Stock (including without limitation, Common Stock or such other securities which may be deemed to be beneficially owned by the undersigned in accordance

with the rules and regulations of the Securities and Exchange Commission and securities which may be issued upon exercise of a stock option or warrant), or publicly disclose the intention to make any offer, sale, pledge or disposition, (2) enter into any swap or other agreement that transfers, in whole or in part, any of the economic consequences of ownership of the Common Stock or such other securities, whether any such transaction described in clause (1) or (2) above is to be settled by delivery of Common Stock or such other securities, in cash or otherwise or (3) make any demand for or exercise any right with respect to the registration of any shares of Common Stock or any security convertible into or exercisable or exchangeable for Common Stock, in each case other than with respect to (A) the Securities to be sold by the undersigned pursuant to the Underwriting Agreement, (B) transfers of shares of Common Stock (i) as a bona fide gift or gifts, (ii) by will, other testamentary document or intestate succession, (iii) to any trust for the direct or indirect benefit of the undersigned or an immediate family member of the undersigned, or to any other entity that is wholly-owned by such persons (for purposes hereof, "immediate family" shall mean any relationship by blood, marriage or adoption, not more remote than first cousin), (iv) if the undersigned is a trust, transfers to the trustor or beneficiary of such trust, (v) transfers to any immediate family member or any investment fund or other entity controlled or managed by the undersigned not for value, and (vi) transfers to a nominee or custodian of a person or entity to whom a disposition or transfer would be permissible under clauses (i) through (v); (C) if the undersigned is a corporation, partnership or other business entity, transfers or distributions of shares of Common Stock or any security convertible into or exercisable or exchangeable for shares of Common Stock to members, partners, stockholders or affiliates of the undersigned (other than the Company and its controlled affiliates), including investment funds or other entities under common control or management with the undersigned; or (D) (i) the repurchase of the Common Stock or such other securities by the Company pursuant to stock option agreements or other equity award agreements providing for the right of said repurchase in connection with the termination of the undersigned's employment or consulting service with the Company, (ii) transfers of shares of Common Stock acquired in open market transactions after the completion of the Public Offering, (iii) tenders, sales or other transfers in response to a bona fide third-party takeover bid made to all holders of Common Stock or any other acquisition transaction, in each case in a change in control transaction whereby all or substantially all of the Class A Common Stock are acquired by a third party (provided that if such transaction is not consummated, the subject Common Stock shall remain subject to the restrictions set forth herein) and that has been approved by the board of directors of the Company and will occur after the Public Offering, (iv) the exercise, including by "net" exercise, of any options to acquire shares of Common Stock or the conversion of any convertible security into Common Stock described in the Prospectus, or issued pursuant to an equity plan described in the Prospectus or the conversion of shares of Common Stock pursuant to the recapitalization transaction described in the Prospectus, it being understood that any such shares of Common Stock received by the undersigned upon such exercise or conversion shall be subject to the restrictions set forth in this Letter Agreement; and (v) transfers to the Company in connection with, and to the extent necessary to fund, the payment of taxes due with respect to the vesting of restricted stock or vesting or exercise of similar rights to purchase Common Stock or any securities convertible into or exercisable or exchangeable for Common Stock pursuant to an equity plan described in the Prospectus; provided that in the case of any transfer or distribution pursuant to clause (B) or (C), each donee or distributee shall execute and deliver to the Representatives a lock-up letter in the form of this paragraph; and provided, further, that in the case of any transfer or distribution pursuant to clause (B) or (C), no filing by any party (donor, donee, transferor or transferee) under the Securities Exchange Act of 1934, as amended, or other public announcement shall be required or shall be made voluntarily in connection with such transfer or distribution (other than a filing on a Form 5 made after the expiration of the Restricted Period referred to above); provided, further, in the case of clause (D)(i), any filing under Section 16(a) of the Exchange Act in connection with such transfer shall disclose that such transfer was as a result of the repurchase of the Common Stock or such other securities by the Company pursuant to stock option agreements or other equity award agreements providing for the right of said repurchase in connection with the termination of the undersigned's employment or consulting service with the Company, and in the case of clause (D)(ii) that no filing by any party under Section 16(a) of the Exchange Act

shall be required or shall be made voluntarily in connection with such transfer during the Lockup Period, and in the case of clause D(iv) any filing under Section 16(a) of the Exchange Act in connection with such exercise shall disclose only the exercise of the option and shall not disclose in any filing under Section 16(a) during the Lockup Period any disposition of the shares of Common Stock underlying the option, and in the case of clause D(v) any filing under Section 16(a) of the Exchange Act in connection with such transfer shall disclose that such transfer was to cover the payment of taxes due with respect to the vesting of restricted stock or similar rights to purchase Common Stock or any securities convertible into or exercisable or exchangeable for Common Stock pursuant to an equity plan described in the Prospectus.

Furthermore, the undersigned may, if permitted by the Company, establish a written trading plan meeting the requirements of Rule 10b5-1 under the Exchange Act; provided that no sales or other transfers occur under such plan and no public disclosure of such plan shall be required or shall be made by any person during the Lockup Period.

If the undersigned is an officer or director of the Company, (i) J.P. Morgan Securities LLC and RBC Capital Markets, LLC on behalf of the Underwriters agree that, at least three business days before the effective date of any release or waiver of the foregoing restrictions in connection with a transfer of shares of Common Stock, J.P. Morgan Securities LLC and RBC Capital Markets, LLC on behalf of the Underwriters will notify the Company of the impending release or waiver, and (ii) the Company has agreed in the Underwriting Agreement to announce the impending release or waiver by press release through a major news service at least two business days before the effective date of the release or waiver. Any release or waiver granted by J.P. Morgan Securities LLC and RBC Capital Markets, LLC on behalf of the Underwriters hereunder to any such officer or director shall only be effective two business days after the publication date of such press release. The provisions of this paragraph will not apply if (a) the release or waiver is effected solely to permit a transfer not for consideration and (b) the transferee has agreed in writing to be bound by the same terms described in this Letter Agreement to the extent and for the duration that such terms remain in effect at the time of the transfer.

In furtherance of the foregoing, the Company, and any duly appointed transfer agent for the registration or transfer of the securities described herein, are hereby authorized to decline to make any transfer of securities if such transfer would constitute a violation or breach of this Letter Agreement.

The undersigned hereby represents and warrants that the undersigned has full power and authority to enter into this Letter Agreement. All authority herein conferred or agreed to be conferred and any obligations of the undersigned shall be binding upon the successors, assigns, heirs or personal representatives of the undersigned.

The undersigned understands that, if (i) prior to signing the Underwriting Agreement, the Company notifies the Underwriters that it does not intend to proceed with the Public Offering, (ii) the Underwriting Agreement (other than the provisions thereof which survive termination) shall terminate or be terminated prior to payment for and delivery of the Common Stock to be sold thereunder, (iii) the Registration Statement is withdrawn by the Company prior to the completion of the Public Offering or (iv) the Public Offering is not completed by February 14, 2018, the undersigned shall be released from all obligations under this Letter Agreement. The undersigned understands that the Underwriters are entering into the Underwriting Agreement and proceeding with the Public Offering in reliance upon this Letter Agreement.

This Letter Agreement and any claim, controversy or dispute arising under or related to this Letter Agreement shall be governed by and construed in accordance with the laws of the State of New York.

Very truly yours,  
[NAME OF STOCKHOLDER]

By: \_\_\_\_\_  
Name:  
Title:

## ALTAIR ENGINEERING INC.

## CERTIFICATE OF INCORPORATION

## ARTICLE I

The name of the Corporation is Altair Engineering Inc.

## ARTICLE II

The address of the Corporation's registered office in the State of Delaware is 108 West 13th Street, Wilmington, Delaware 19801, County of New Castle. The name of its registered agent at such address is Business Filings Incorporated.

## ARTICLE III

The purpose of the Corporation is to engage in any lawful act or activity for which corporations may be organized under the Delaware General Corporation Law (the "DGCL").

## ARTICLE IV

A. Classes of Stock. The total number of shares of capital stock that the Corporation shall have authority to issue is six hundred million (600,000,000), consisting of the following: five hundred thirteen million seven hundred ninety-six thousand five hundred seventy-two (513,796,572) shares of Class A Common Stock, par value \$.0001 per share ("**Class A Common Stock**"), forty-one million two hundred three thousand four hundred twenty-eight (41,203,428) shares of Class B Common Stock, par value \$.0001 per share ("**Class B Common Stock**"), and forty-five million (45,000,000) shares of undesignated Preferred Stock, par value \$.0001 per share ("**Preferred Stock**").

B. Rights of Preferred Stock. The Board of Directors of the Corporation (the "**Board of Directors**") is authorized, subject to any limitations prescribed by law, but to the fullest extent permitted by law, to provide by resolution for the issuance of shares of Preferred Stock in series, and by filing a certificate pursuant to the applicable law of the State of Delaware (such certificate being hereinafter referred to as a "**Preferred Stock Designation**"), to establish from time to time the number of shares to be included in each such series, and to fix the designation, powers, (which may include, without limitation, full, limited or no voting powers), preferences, and relative, participating, optional or other rights of the shares of each such series and any qualifications, limitations or restrictions thereof.

C. Vote to Increase or Decrease Authorized Shares of Preferred Stock. The number of authorized shares of Preferred Stock may be increased or decreased (but not below the number of shares thereof then outstanding) by the affirmative vote of the holders of a majority of the voting power of all of the outstanding shares of capital stock of the Corporation entitled to vote thereon, without a separate class vote of the holders of Preferred Stock, or any separate series votes of any series thereof, unless a vote of any such holders is required pursuant to the terms of any Preferred Stock Designation.

D. Rights of Class A Common Stock and Class B Common Stock. The relative powers, rights, qualifications, limitations and restrictions granted to or imposed on the shares of Class A Common Stock and Class B Common Stock are as follows:

1. Voting Rights.

(a) General Right to Vote Together; Exception. Except as otherwise expressly provided herein or required by applicable law, the holders of Class A Common Stock and Class B Common Stock shall vote together as one class on all matters submitted to a vote of the stockholders; *provided, however*, that subject to the terms of any Preferred Stock Designation, the number of authorized shares of Class A Common Stock or Class B Common Stock may be increased or decreased (but not below the number of shares thereof then outstanding) by the affirmative vote of the holders of a majority of the voting power of the capital stock of the Corporation entitled to vote, irrespective of the provisions of Section 242(b)(2) of the DGCL.

(b) Votes Per Share. Except as otherwise expressly provided herein or required by applicable law, on any matter that is submitted to a vote of the stockholders, each holder of Class A Common Stock shall be entitled to one (1) vote for each such share, and each holder of Class B Common Stock shall be entitled to ten (10) votes for each such share.

2. Identical Rights. Except as otherwise expressly provided herein or required by applicable law, shares of Class A Common Stock and Class B Common Stock shall have the same rights and privileges and rank equally, share ratably and be identical in all respects as to all matters, including, without limitation:

(a) Dividends and Distributions. Subject to the preferences applicable to any series of Preferred Stock, if any, outstanding at any time, shares of Class A Common Stock and Class B Common Stock shall be treated equally, identically and ratably, on a per share basis, with respect to any Distribution paid or distributed by the Corporation, unless different treatment of the shares of each such class is approved by the affirmative vote of the holders of a majority of the outstanding shares of Class A Common Stock and by the affirmative vote of the holders of a majority of the outstanding shares of Class B Common Stock, each voting separately as a class; *provided, however*, that if a Distribution is paid in the form of Class A Common Stock or Class B Common Stock (or Rights to acquire such stock), then holders of Class A Common Stock shall receive Class A Common Stock (or Rights to acquire such stock, as the case may be) and holders of Class B Common Stock shall receive Class B Common Stock (or Rights to acquire such stock, as the case may be).



(b) Subdivision or Combination. If the Corporation in any manner subdivides or combines the outstanding shares of Class A Common Stock or Class B Common Stock, the outstanding shares of the other such class will be subdivided or combined in the same proportion and manner, unless different treatment of the shares of each such class is approved by the affirmative vote of the holders of a majority of the outstanding shares of Class A Common Stock and by the affirmative vote of the holders of a majority of the outstanding shares of Class B Common Stock, each voting separately as a class.

(c) Equal Treatment in a Change of Control or any Merger Transaction. In connection with any Change of Control Transaction, shares of Class A Common Stock and Class B Common Stock shall be treated equally, identically and ratably, on a per share basis, with respect to any consideration into which such shares are converted or any consideration paid or otherwise distributed to stockholders of the Corporation, unless different treatment of the shares of each such class is approved by the affirmative vote of the holders of a majority of the outstanding shares of Class A Common Stock and by the affirmative vote of the holders of a majority of the outstanding shares of Class B Common Stock, each voting separately as a class. Any merger or consolidation of the Corporation with or into any other entity that does not constitute a Change of Control Transaction shall require approval by the affirmative vote of the holders of a majority of the outstanding shares of Class A Common Stock and by the affirmative vote of the holders of a majority of the outstanding shares of Class B Common Stock, each voting separately as a class, unless (i) the shares of Class A Common Stock and Class B Common Stock remain outstanding and no other consideration is received in respect thereof or (ii) such shares are converted on a pro rata basis into shares of the surviving or parent entity in such transaction having identical rights to the shares of Class A Common Stock and Class B Common Stock, respectively.

### 3. Conversion of Class B Common Stock.

(a) Voluntary Conversion. Each one (1) share of Class B Common Stock shall be convertible into one (1) share of Class A Common Stock at the option of the holder thereof at any time upon written notice to the transfer agent of the Corporation.

(b) Automatic Conversion.

(i) Shares of Class B Common Stock shall automatically, without any further action, convert into an equal number of shares of fully paid and nonassessable shares of Class A Common Stock upon a Transfer of such share; *provided* that no such automatic conversion shall occur in the case of a Transfer from a Founder or a Founder's Permitted Transferee to another Founder or such Founder's Permitted Transferee and from any such Permitted Transferee back to such Founder and/or any other Permitted Transferee established by or for such Founder.

(ii) In the event any Beneficial Owner of shares of Class B Common Stock, Beneficially Owns shares of Class B Common Stock constituting less than 3% of the outstanding shares of Class B Common Stock, then all of the shares of Class B Common Stock held by such Beneficial Owner shall automatically, without further action, convert into an equal number of fully paid and nonassessable shares of Class A Common Stock.

(iii) In the event the Key Holders Beneficially Own, in the aggregate, more shares of Class B Common Stock than the Executive Holder Beneficially Owns, then all shares of Class B Common Stock held by all holders of Class B Common Stock, other than the Executive Holder, shall automatically, without further action, convert into an equal number of fully paid and nonassessable shares of Class A Common Stock; provided, that, in furtherance thereof, after giving effect to such conversion the only outstanding shares of Class B Common Stock shall be those held by the Executive Holder.

(iv) In the event the Executive Holder is no longer either (i) an executive officer of the Corporation, or (ii) a director of the Corporation, then all shares of Class B Common Stock held by all holders of Class B Common Stock shall automatically, without further action, convert into an equal number of fully paid nonassessable shares of Class A Common Stock.

(c) Conversion Upon Death or Incapacity of a Class B Stockholder.

(i) All shares of Class B Common Stock Beneficially Owned by a Class B Stockholder, other than a Founder, who is a natural person, shall automatically, without any further action, convert into an equal number of fully paid and nonassessable shares of Class A Common Stock upon the death or Incapacity of such Class B Stockholder.

(ii) Upon the death or Incapacity of a Key Holder, all shares of Class B Common Stock Beneficially Held by such Key Holder, or by such Key Holder's Permitted Transferees, shall automatically, without any further action, convert into fully paid and nonassessable shares of Class A Common Stock upon that date which is nine (9) months after the date of death or Incapacity of the Key Holder.

(iii) Upon the death or Incapacity of the Executive Holder, all shares of Class B Common Stock Beneficially Held by all Class B Stockholders shall automatically, without any further action, convert into fully paid and nonassessable shares of Class A Common Stock upon that date which is nine (9) months after the date of death or Incapacity of such Executive Holder.

(d) Automatic Conversion of all Outstanding Class B Common Stock. Each share of Class B Common Stock shall automatically, without any further action, convert into a share of Class A Common Stock upon the date specified by affirmative vote of the holders of at least sixty-six and two-thirds percent (66-2/3%) of the outstanding shares of Class B Common Stock, voting as a single class.

(e) Final Conversion of Class B Common Stock. At the Final Conversion Time, all shares of Class B Common Stock shall automatically, without any further action, convert into an equal number of fully paid and nonassessable shares of Class A Common Stock. Following such conversion, the reissuance of all shares of Class B Common Stock shall be prohibited, and such shares shall be retired and cancelled in accordance with Section 243 of the DGCL and the filing by the Secretary of State of the State of Delaware required thereby, and upon such retirement and cancellation, all references to Class B Common Stock in this Certificate of Incorporation shall be eliminated.

(f) Procedures. The Corporation may, from time to time, establish such policies and procedures relating to the conversion of Class B Common Stock to Class A Common Stock and the general administration of this dual class stock structure, including the issuance of stock certificates with respect thereto, as it may deem reasonably necessary or advisable, and may from time to time request that holders of shares of Class B Common Stock furnish certifications, affidavits or other proof to the Corporation as it deems necessary to verify the ownership of Class B Common Stock and to confirm that a conversion to Class A Common Stock has not occurred. A determination by the Secretary of the Corporation or the Board of Directors or a duly authorized committee thereof as to whether a Transfer results in a conversion to Class A Common Stock shall be conclusive and binding.

(g) Immediate Effect. In the event of a conversion of shares of Class B Common Stock to shares of Class A Common Stock pursuant to this Section D.3 or at the Final Conversion Time, such conversion(s) shall be deemed to have been made at the time that the Transfer of shares occurred or immediately at the Final Conversion Time, as applicable. Upon any conversion of Class B Common Stock to Class A Common Stock, all rights of the holder of shares of Class B Common Stock shall cease and the person or persons in whose name or names the certificate or certificates representing the shares of Class A Common Stock are to be issued shall be treated for all purposes as having become the record holder or holders of such shares of Class A Common Stock. Shares of Class B Common Stock that are converted into shares of Class A Common Stock as provided in this Section D.3 shall be retired and may not be reissued.

(h) Reservation of Stock. The Corporation shall at all times reserve and keep available out of its authorized but unissued shares of Class A Common Stock, solely for the purpose of effecting the conversion of the shares of Class B Common Stock, such number of its shares of Class A Common Stock as shall from time to time be sufficient to effect the conversion of all outstanding shares of Class B Common Stock into shares of Class A Common Stock.

E. **No Further Issuances.** Except for the issuance of Class B Common Stock issuable upon exercise of Rights outstanding at the Effective Time or a dividend payable in accordance with Article IV, Section D.2(a), the Corporation shall not at any time after the Effective Time issue any additional shares of Class B Common Stock, unless such issuance is approved by the affirmative vote of the holders of a majority of the outstanding shares of Class A Common Stock and the holders of a majority of the outstanding shares of Class B Common Stock, each voting separately as a class. After the Final Conversion Time, the Corporation shall not issue any additional shares of Class B Common Stock.

## ARTICLE V

The following terms, where capitalized in this Certificate of Incorporation, shall have the meanings ascribed to them in this Article V:

**“Beneficial Owner”** means, with respect to any shares of capital stock, a person who has, or shares, voting power, which includes the power to vote or to direct the voting of such shares of capital stock, or investment power, which includes the power to dispose of or to direct the disposition of such shares. The term **“Beneficially Own”** **“Beneficially Owns”**, **“Beneficially Owned”**, **“Beneficial Ownership”** and **“Beneficially Held”** shall have the correlative meanings.

**“Change of Control Share Issuance”** means the issuance by the Corporation, in a transaction or series of related transactions, of voting securities representing more than two percent (2%) of the total voting power (assuming Class A Common Stock and Class B Common Stock each have one (1) vote per share) of the Corporation before such issuance to any person or persons acting as a group as contemplated in Rule 13d-5(b) under the Exchange Act (or any successor provision) that immediately prior to such transaction or series of related transactions held fifty percent (50%) or less of the total voting power of the Corporation (assuming Class A Common Stock and Class B Common Stock each have one (1) vote per share), such that, immediately following such transaction or series of related transactions, such person or group of persons would hold more than fifty percent (50%) of the total voting power of the Corporation (assuming Class A Common Stock and Class B Common Stock each have one (1) vote per share).

**“Change of Control Transaction”** means (i) the sale, lease, exchange, or other disposition (other than liens and encumbrances created in the ordinary course of business, including liens or encumbrances to secure indebtedness for borrowed money that are approved by the Corporation’s Board of Directors, so long as no foreclosure occurs in respect of any such lien or encumbrance) of all or substantially all of the Corporation’s property and assets (which shall for such purpose include the property and assets of any direct or indirect subsidiary of the Corporation), *provided that* any sale, lease, exchange or other disposition of property or assets exclusively between or among the Corporation and any direct or indirect subsidiary or subsidiaries of the Corporation shall not be deemed a **“Change of Control Transaction”**; (ii) the merger, consolidation, business combination, or other similar transaction of the Corporation with any other entity, other than a merger, consolidation, business combination, or other similar transaction that would result in the voting securities of the Corporation outstanding immediately prior thereto

continuing to represent (either by remaining outstanding or by being converted into voting securities of the surviving entity or its parent) more than fifty percent (50%) of the total voting power represented by the voting securities of the Corporation *and* more than fifty percent (50%) of the total number of outstanding shares of the Corporation's capital stock, in each case as outstanding immediately after such merger, consolidation, business combination, or other similar transaction, and the stockholders of the Corporation immediately prior to the merger, consolidation, business combination, or other similar transaction own voting securities of the Corporation, the surviving entity or its parent immediately following the merger, consolidation, business combination, or other similar transaction in substantially the same proportions (vis a vis each other) as such stockholders owned the voting securities of the Corporation immediately prior to the transaction; (iii) a recapitalization, liquidation, dissolution, or other similar transaction involving the Corporation, other than a recapitalization, liquidation, dissolution, or other similar transaction that would result in the voting securities of the Corporation outstanding immediately prior thereto continuing to represent (either by remaining outstanding or being converted into voting securities of the surviving entity or its parent) more than fifty percent (50%) of the total voting power represented by the voting securities of the Corporation *and* more than fifty percent of the total number of outstanding shares of the Corporation's capital stock, in each case as outstanding immediately after such recapitalization, liquidation, dissolution or other similar transaction, and the stockholders of the Corporation immediately prior to the recapitalization, liquidation, dissolution or other similar transaction own voting securities of the Corporation, the surviving entity or its parent immediately following the recapitalization, liquidation, dissolution or other similar transaction in substantially the same proportions (vis a vis each other) as such stockholders owned the voting securities of the Corporation immediately prior to the transaction; and (iv) any Change of Control Share Issuance.

**"Class B Stockholder"** means (i) the registered holder of a share of Class B Common Stock at the Effective Time and (ii) the initial registered holder of any shares of Class B Common Stock that are originally issued by the Corporation after the Effective Time.

**"Distribution"** means (i) any dividend or distribution of cash, property or shares of the Corporation's capital stock; and (ii) any distribution following or in connection with any liquidation, dissolution or winding up of the Corporation, either voluntary or involuntary.

**"Exchange Act"** means the U.S. Securities Exchange Act of 1934, as amended.

**"Executive Holder"** means James R. Scapa.

**"Final Conversion Time"** means the earlier to occur of: (i) the twelfth (12<sup>th</sup>) anniversary of the Effective Time or (ii) the date on which the Executive Holder has Beneficial Ownership of less than 10% of the capital stock of the Corporation.

**"Founders"** means James R. Scapa, George J. Christ and Mark E. Kistner, or any of them.

**"Incapacity"** shall mean that such holder is incapable of managing his or her financial affairs under the criteria set forth in the applicable probate code that can be expected to result in death or which has lasted or can be expected to last for a continuous period of not less than twelve (12) months as determined by a licensed practitioner. In the event of a dispute regarding whether a Class B Stockholder has suffered an Incapacity, no Incapacity of such holder will be deemed to have occurred unless and until an affirmative ruling regarding such Incapacity has been made by a court of competent jurisdiction.

“**Key Holders**” means George J. Christ and Mark E. Kistner, or either of them.

“**Permitted Transferee**” means, with respect to a Founder:

(A) a trust for the benefit of such Founder or persons other than the Founder so long as the Founder has sole dispositive power and exclusive Voting Control with respect to the shares of the Founder held by such trust; *provided* that if such Founder no longer has sole dispositive power and exclusive Voting Control with respect to the shares of Class B Common Stock held by such trust, each share of Class B Common Stock then held by such trust shall automatically convert into one (1) fully paid and nonassessable share of Class A Common Stock;

(B) a trust under the terms of which such Founder has retained a “qualified interest” within the meaning of §2702(b) of the Internal Revenue Code and/or a reversionary interest so long as the Founder has sole dispositive power and exclusive Voting Control with respect to the shares of Class B Common Stock held by such trust; *provided, however*, that if the Founder no longer has sole dispositive power and exclusive Voting Control with respect to the shares of Class B Common Stock held by such trust, each share of Class B Common Stock then held by such trust shall automatically convert into one (1) fully paid and nonassessable share of Class A Common Stock;

(C) an Individual Retirement Account, as defined in Section 408(a) of the Internal Revenue Code, or a pension, profit sharing, stock bonus or other type of plan or trust of which such Founder is a participant or beneficiary and which satisfies the requirements for qualification under Section 401 of the Internal Revenue Code; *provided* that in each case such Founder has sole dispositive power and exclusive Voting Control with respect to the shares of Class B Common Stock held in such account, plan or trust, and *provided, further*, that if the Founder no longer has sole dispositive power and exclusive Voting Control with respect to the shares of Class B Common Stock held by such account, plan or trust, each share of Class B Common Stock then held by such trust shall automatically convert into one (1) fully paid and nonassessable share of Class A Common Stock; and

(D) a corporation, partnership or limited liability company in which such Founder directly, or indirectly through one or more Permitted Transferees, owns shares, partnership interests or membership interests, as applicable, with sufficient Voting Control in the corporation, partnership or limited liability company, as applicable, or otherwise has legally enforceable rights, such that the Founder retains sole dispositive power and exclusive Voting Control with respect to the shares of Class B Common Stock held by such corporation, partnership or limited liability company; *provided* that if the Founder no longer owns sufficient shares, partnership interests or membership interests, as applicable, or no longer has sufficient legally enforceable rights to ensure the Founder retains sole dispositive power and exclusive Voting Control with respect to the shares of Class B

Common Stock held by such corporation, partnership or limited liability company, as applicable, each share of Class B Common Stock then held by such corporation, partnership or limited liability company, as applicable, shall automatically convert into one (1) fully paid and nonassessable share of Class A Common Stock.

“**Rights**” means any option, warrant, conversion right or contractual right of any kind to acquire shares of the Corporation’s authorized but unissued capital stock.

“**Securities Act**” means the U.S. Securities Act of 1933, as amended.

“**Securities Exchange**” means, at any time, the registered national securities exchange on which the Corporation’s equity securities are then principally listed or traded, which shall be the New York Stock Exchange or NASDAQ Market (or similar national quotation system of the NASDAQ Stock Market) (“**NASDAQ**”) or any successor exchange of either the New York Stock Exchange or NASDAQ.

“**Trading Day**” means any day on which the Securities Exchange is open for trading.

“**Transfer**” of a share of Class B Common Stock shall mean any sale, assignment, transfer, conveyance, hypothecation or other transfer or disposition of such share or any legal or beneficial interest in such share, whether or not for value and whether voluntary or involuntary or by operation of law. A “**Transfer**” shall also include, without limitation and for the avoidance of doubt, (i) a Transfer of a share of Class B Common Stock to a broker or other nominee (regardless of whether or not there is a corresponding change in beneficial ownership) or (ii) the Transfer of, or entering into a binding agreement with respect to, Voting Control over a share of Class B Common Stock by proxy or otherwise; *provided, however*, that the following shall not be considered a “**Transfer**”: (a) entering into a support or similar voting agreement (with or without granting a proxy) in connection with a Change of Control Transaction that has been approved by the Board of Directors of the Corporation; (b) the grant of a proxy to officers or directors of the Corporation at the request of the Board of Directors of the Corporation in connection with actions to be taken at an annual or special meeting of stockholders or the grant of a revocable proxy given to any other person in response to a public proxy or consent solicitation made pursuant to, and in accordance with, the applicable provisions of the General Rules and Regulations promulgated under the Exchange Act; (c) the pledge of shares of Class B Common Stock by a Class B Stockholder that creates a mere security interest in such shares pursuant to a *bona fide* loan or indebtedness transaction so long as the Class B Stockholder continues to exercise Voting Control over such pledged shares; *provided, however*, that a foreclosure on such shares of Class B Common Stock or other similar action by the pledgee shall constitute a “**Transfer**”; or (d) the fact that, as of the Effective Time or at any time after the Effective Time, the spouse of any Class B Stockholder possesses or obtains an interest in such holder’s shares of Class B Common Stock arising solely by reason of the application of the community property laws of any jurisdiction, so long as no other event or circumstance shall exist or have occurred that constitutes a “**Transfer**” of such shares of Class B Common Stock.

“**Voting Control**” with respect to a share of Class B Common Stock means the exclusive power (whether directly or indirectly) to vote or direct the voting of such share of Class B Common Stock by proxy, voting agreement, or otherwise.

## ARTICLE VI

A. General Powers. The business and affairs of the Corporation shall be managed by or under the direction of the Board of Directors.

B. Number of Directors; Election. Subject to the rights of holders of any series of Preferred Stock with respect to the election of directors, the number of directors that constitutes the entire Board of Directors of the Corporation shall be fixed solely by resolution of the Board of Directors. Subject to the rights of holders of any series of Preferred Stock with respect to the election of directors, each director of the Corporation shall hold office until the expiration of the term for which he or she is elected and until his or her successor has been duly elected and qualified or until his or her earlier resignation, death or removal.

C. Classified Board Structure. From and after the Effective Time, and subject to the rights of holders of any series of Preferred Stock with respect to the election of directors, the directors of the Corporation shall be divided into three (3) classes as nearly equal in size as is practicable, hereby designated Class I, Class II and Class III. The Board of Directors may assign members of the Board of Directors already in office to such classes at the time such classification becomes effective. The term of office of the initial Class I directors shall expire at the first regularly-scheduled annual meeting of stockholders following the Effective Time, the term of office of the initial Class II directors shall expire at the second annual meeting of stockholders following the Effective Time and the term of office of the initial Class III directors shall expire at the third annual meeting of stockholders following the Effective Time. At each annual meeting of stockholders, commencing with the first regularly-scheduled annual meeting of stockholders following the Effective Time, each of the successors elected to replace the directors of a Class whose term shall have expired at such annual meeting shall be elected to hold office until the third annual meeting next succeeding his or her election and until his or her respective successor shall have been duly elected and qualified.

Notwithstanding the foregoing provisions of this Article VI, and subject to the rights of holders of any series of Preferred Stock with respect to the election of directors, each director shall serve until his or her successor is duly elected and qualified or until his or her death, resignation, or removal. Subject to the rights of holders of any series of Preferred Stock with respect to the election of directors, if the number of directors is hereafter changed, any newly created directorships or decrease in directorships shall be so apportioned among the classes as to make all classes as nearly equal in number as is practicable, provided that no decrease in the number of directors constituting the Board of Directors shall shorten the term of any incumbent director.

D. Removal; Vacancies. Subject to the rights of holders of any series of Preferred Stock with respect to the election of directors, any director may be removed from office by the stockholders of the Corporation only for cause. Subject to the rights of holders of Preferred Stock and unless permitted in the specific case by resolution of the Board of Directors, vacancies occurring on the Board of Directors for any reason and newly created directorships resulting from an increase in the authorized number of directors may be filled only by vote of a majority of the remaining members of the Board of Directors, although less than a quorum, or by a sole remaining director, and not by stockholders. A person so elected by the Board of Directors to fill a vacancy or newly created directorship shall hold office until the next election of the class for which such director shall have been chosen and until his or her successor shall be duly elected and qualified.



## ARTICLE VII

A. Written Ballot. Elections of directors need not be by written ballot unless the Bylaws of the Corporation shall so provide.

B. Amendment of Bylaws. In furtherance and not in limitation of the powers conferred by statute, the Board of Directors is expressly authorized to adopt, amend or repeal the Bylaws of the Corporation.

C. Special Meetings. Special meetings of the stockholders may be called only by (i) the Board of Directors pursuant to a resolution adopted by a majority of the entire Board of Directors; (ii) the chairman of the Board of Directors; (iii) the chief executive officer of the Corporation; or (iv) the president of the Corporation (in the absence of a chief executive officer).

D. No Stockholder Action by Written Consent. Subject to the rights of the holders of any series of Preferred Stock, no action shall be taken by the stockholders of the Corporation except at an annual or special meeting of the stockholders called in accordance with the Bylaws, and no action shall be taken by the stockholders by written consent; provided, however, that this Section VII,D shall only apply on and after the first date on which a registration statement on Form S-1 filed by the Corporation with the Securities and Exchange Commission is declared effective by the Securities and Exchange Commission.

E. No Cumulative Voting. No stockholder will be permitted to cumulate votes at any election of directors.

## ARTICLE VIII

To the fullest extent permitted by the DGCL, as it presently exists or may hereafter be amended from time to time, a director of the Corporation shall not be personally liable to the Corporation or its stockholders for monetary damages for breach of fiduciary duty as a director or otherwise. If the DGCL is amended to authorize corporate action further eliminating or limiting the personal liability of directors, then the liability of a director of the Corporation shall be eliminated or limited to the fullest extent permitted by the DGCL, as so amended.

Neither any amendment nor repeal of this Article VIII, nor the adoption of any provision of the Corporation's Certificate of Incorporation inconsistent with this Article VIII, shall eliminate or reduce the effect of this Article VIII in respect of any matter occurring, or any cause of action, suit or proceeding accruing or arising or that, but for this Article VIII, would accrue or arise, prior to such amendment, repeal or adoption of an inconsistent provision.

## ARTICLE IX

Subject to any provisions in the Bylaws of the Corporation related to indemnification of directors, officers or agents of the Corporation, the Corporation shall indemnify, to the fullest

extent permitted by applicable law, any director, officer or agent of the Corporation who was or is a party or is threatened to be made a party to any threatened, pending or completed action, suit or proceeding, whether civil, criminal, administrative or investigative (a “**Proceeding**”) by reason of the fact that he or she is or was a director, officer, employee or agent of the Corporation or is or was serving at the request of the Corporation as a director, officer, employee or agent of another corporation, partnership, joint venture, trust or other enterprise, including service with respect to employee benefit plans, against expenses (including attorneys’ fees), judgments, fines and amounts paid in settlement actually and reasonably incurred by such person in connection with any such Proceeding; provided, however, that the Corporation be required to indemnify a person in connection with a Proceeding (or part thereof) initiated by such person only if such Proceeding (or part thereof) was authorized by the Board of Directors.

The Corporation shall have the power to indemnify, to the extent permitted by the DGCL, as it presently exists or may hereafter be amended from time to time, any employee or agent of the Corporation who was or is a party or is threatened to be made a party to any Proceeding by reason of the fact that he or she is or was a director, officer, employee or agent of the Corporation or is or was serving at the request of the Corporation as a director, officer, employee or agent of another corporation, partnership, joint venture, trust or other enterprise, including service with respect to employee benefit plans, against expenses (including attorneys’ fees), judgments, fines and amounts paid in settlement actually and reasonably incurred by such person in connection with any such Proceeding.

A right to indemnification or to advancement of expenses arising under a provision of this Certificate of Incorporation or the Bylaws of the Corporation shall not be eliminated or impaired by an amendment to this Certificate of Incorporation or the Bylaws of the Corporation after the occurrence of the act or omission that is the subject of the civil, criminal, administrative or investigative action, suit or proceeding for which indemnification or advancement of expenses is sought, unless the provision in effect at the time of such act or omission explicitly authorizes such elimination or impairment after such action or omission has occurred.

## **ARTICLE X**

If any provision of this Certificate of Incorporation becomes or is declared on any ground by a court of competent jurisdiction to be illegal, unenforceable or void, portions of such provision, or such provision in its entirety, to the extent necessary, shall be severed from this Certificate of Incorporation, and the court will replace such illegal, void or unenforceable provision of this Certificate of Incorporation with a valid and enforceable provision that most accurately reflects the Corporation’s intent, in order to achieve, to the maximum extent possible, the same economic, business and other purposes of the illegal, void or unenforceable provision. The balance of this Certificate of Incorporation shall be enforceable in accordance with its terms.

Except as provided in ARTICLE VIII and ARTICLE IX above, the Corporation reserves the right to amend, alter, change or repeal any provision contained in this Certificate of Incorporation, in the manner now or hereafter prescribed by statute, and all rights conferred upon stockholders herein are granted subject to this reservation; provided, however, that, notwithstanding any other provision of this Certificate of Incorporation or any provision of law

that might otherwise permit a lesser vote or no vote, but in addition to any vote of the holders of any class or series of the stock of this Corporation required by law or by this Certificate of Incorporation, the affirmative vote of the holders of at least sixty-six and two-thirds percent (66-2/3%) of the voting power of the outstanding shares of the capital stock of the Corporation entitled to vote thereon, voting together as a single class, shall be required to amend, repeal or adopt any provision of this Certificate of Incorporation inconsistent with ARTICLE VI, ARTICLE VII, ARTICLE VIII, ARTICLE IX or this ARTICLE X; provided, further, that, notwithstanding any other provision of this Certificate of Incorporation or any provision of law that might otherwise permit a lesser vote or no vote, any amendment of this proviso, Sections D.3(a) through (e) of ARTICLE IV or any of the defined terms set forth in ARTICLE V, but only to the extent such defined terms are used in Sections D.3(a) through (e) of ARTICLE IV, shall require the affirmative vote of the holders of a majority of the outstanding shares of Class A Common Stock and the holders of a majority of the outstanding shares of Class B Common Stock, each voting separately as a class.

#### ARTICLE XI

The incorporator of the Corporation is Selim Day, whose mailing address is c/o of Lowenstein Sandler LLP, 1251 Avenue of the Americas, New York, New York 10020.

The undersigned incorporator hereby acknowledges that the foregoing certificate of incorporation is his act and deed on this fifth day of October, 2017.

\_\_\_\_\_  
Selim Day, Incorporator

**BYLAWS OF ALTAIR ENGINEERING INC.**  
(a Delaware corporation)

## TABLE OF CONTENTS

	<b>PAGES</b>
ARTICLE I CORPORATE OFFICES	1
1.1 REGISTERED OFFICE	1
1.2 OTHER OFFICES	1
ARTICLE II MEETINGS OF STOCKHOLDERS	1
2.1 PLACE OF MEETINGS	1
2.2 ANNUAL MEETING	1
2.3 SPECIAL MEETING	1
2.4 ADVANCE NOTICE PROCEDURES	2
2.5 NOTICE OF STOCKHOLDERS' MEETINGS	9
2.6 QUORUM	9
2.7 ADJOURNED MEETING; NOTICE	9
2.8 CONDUCT OF BUSINESS	10
2.9 VOTING	10
2.10 STOCKHOLDER ACTION BY WRITTEN CONSENT WITHOUT A MEETING	10
2.11 RECORD DATES	11
2.12 PROXIES	11
2.13 LIST OF STOCKHOLDERS ENTITLED TO VOTE	12
2.14 INSPECTORS OF ELECTION	12
ARTICLE III DIRECTORS	13
3.1 POWERS	13
3.2 NUMBER OF DIRECTORS	13
3.3 ELECTION, QUALIFICATION AND TERM OF OFFICE OF DIRECTORS	13
3.4 RESIGNATION AND VACANCIES	13
3.5 PLACE OF MEETINGS; MEETINGS BY TELEPHONE	14
3.6 REGULAR MEETINGS	14
3.7 SPECIAL MEETINGS; NOTICE	14
3.8 QUORUM; VOTING	15

3.9	BOARD ACTION BY WRITTEN CONSENT WITHOUT A MEETING	15
3.10	FEES AND COMPENSATION OF DIRECTORS	15
3.11	REMOVAL OF DIRECTORS	15
ARTICLE IV COMMITTEES		16
4.1	COMMITTEES OF DIRECTORS	16
4.2	COMMITTEE MINUTES	16
4.3	MEETINGS AND ACTION OF COMMITTEES	16
4.4	SUBCOMMITTEES	17
ARTICLE V OFFICERS		17
5.1	OFFICERS	17
5.2	APPOINTMENT OF OFFICERS	17
5.3	SUBORDINATE OFFICERS	17
5.4	REMOVAL AND RESIGNATION OF OFFICERS	18
5.5	VACANCIES IN OFFICES	18
5.6	REPRESENTATION OF SHARES OF OTHER ENTITIES	18
5.7	AUTHORITY AND DUTIES OF OFFICERS	18
ARTICLE VI STOCK		18
6.1	STOCK CERTIFICATES; PARTLY PAID SHARES	18
6.2	SPECIAL DESIGNATION ON CERTIFICATES	19
6.3	LOST CERTIFICATES	19
6.4	DIVIDENDS	20
6.5	TRANSFER OF STOCK	20
6.6	STOCK TRANSFER AGREEMENTS	20
6.7	REGISTERED STOCKHOLDERS	20
ARTICLE VII MANNER OF GIVING NOTICE AND WAIVER		21
7.1	NOTICE OF STOCKHOLDERS' MEETINGS	21
7.2	NOTICE BY ELECTRONIC TRANSMISSION	21
7.3	NOTICE TO STOCKHOLDERS SHARING AN ADDRESS	22
7.4	NOTICE TO PERSON WITH WHOM COMMUNICATION IS UNLAWFUL	22
7.5	WAIVER OF NOTICE	22

ARTICLE VIII INDEMNIFICATION	23
8.1 INDEMNIFICATION OF DIRECTORS AND OFFICERS IN THIRD PARTY PROCEEDINGS	23
8.2 INDEMNIFICATION OF DIRECTORS AND OFFICERS IN ACTIONS BY OR IN THE RIGHT OF THE CORPORATION	23
8.3 SUCCESSFUL DEFENSE	24
8.4 INDEMNIFICATION OF OTHERS	24
8.5 ADVANCE PAYMENT OF EXPENSES	24
8.6 LIMITATION ON INDEMNIFICATION	24
8.7 DETERMINATION; CLAIM	25
8.8 NON-EXCLUSIVITY OF RIGHTS	25
8.9 INSURANCE	26
8.10 SURVIVAL	26
8.11 EFFECT OF REPEAL OR MODIFICATION	26
8.12 CERTAIN DEFINITIONS	26
ARTICLE IX GENERAL MATTERS	27
9.1 EXECUTION OF CORPORATE CONTRACTS AND INSTRUMENTS	27
9.2 FISCAL YEAR	27
9.3 SEAL	27
9.4 CONSTRUCTION; DEFINITIONS	27
9.5 FORUM	27
ARTICLE X AMENDMENTS	28

**BYLAWS OF ALTAIR ENGINEERING INC.**

**ARTICLE I  
CORPORATE OFFICES**

**1.1 REGISTERED OFFICE**

The registered office of Altair Engineering Inc. shall be fixed in the corporation's certificate of incorporation, as the same may be amended from time to time.

**1.2 OTHER OFFICES**

The corporation's board of directors may at any time establish other offices at any place or places within or outside the State of Delaware.

**ARTICLE II  
MEETINGS OF STOCKHOLDERS**

**2.1 PLACE OF MEETINGS**

Meetings of stockholders shall be held at any place, within or outside the State of Delaware, designated by the board of directors. The board of directors may, in its sole discretion, determine that a meeting of stockholders shall not be held at any place, but may instead be held solely by means of remote communication as authorized by Section 211(a)(2) of the Delaware General Corporation Law (the "DGCL"). In the absence of any such designation or determination, stockholders' meetings shall be held at the corporation's principal executive office.

**2.2 ANNUAL MEETING**

The annual meeting of stockholders shall be held on such date, at such time, and at such place (if any) within or outside the State of Delaware as shall be designated from time to time by the board of directors and stated in the corporation's notice of the meeting. At the annual meeting, directors shall be elected in accordance with the corporation's certificate of incorporation and any other proper business, brought in accordance with Section 2.4 of these bylaws, may be transacted. The board of directors may cancel, postpone or reschedule any previously scheduled annual meeting at any time, before or after the notice for such meeting has been sent to the stockholders.

**2.3 SPECIAL MEETING**

(i) A special meeting of the stockholders, other than those required by statute, may be called at any time by (A) the board of directors, (B) the chairperson of the board of directors, (C) the chief executive officer or (D) the president (in the absence of a chief executive officer), but a special meeting may not be called by any other person or persons. The board of directors may cancel, postpone or reschedule any previously scheduled special meeting at any time, before or after the notice for such meeting has been sent to the stockholders.



(ii) The notice of a special meeting shall include the purpose for which the meeting is called. Only such business shall be conducted at a special meeting of stockholders as shall have been brought before the meeting by or at the direction of the board of directors, chairperson of the board of directors, chief executive officer or president (in the absence of a chief executive officer). Nothing contained in this Section 2.3(ii) shall be construed as limiting, fixing or affecting the time when a meeting of stockholders called by action of the board of directors may be held.

## 2.4 ADVANCE NOTICE PROCEDURES

(i) *Advance Notice of Stockholder Business.* At an annual meeting of the stockholders, only such business shall be conducted as shall have been properly brought before the meeting. To be properly brought before an annual meeting, business must be brought: (A) pursuant to the corporation's proxy materials with respect to such meeting, (B) by or at the direction of the board of directors or (C) by a stockholder of the corporation who (1) is a stockholder of record at the time of the giving of the notice required by this Section 2.4(i) and on the record date for the determination of stockholders entitled to vote at the annual meeting and (2) has timely complied in proper written form with the notice procedures set forth in this Section 2.4(i). In addition, for business to be properly brought before an annual meeting by a stockholder, such business must be a proper matter for stockholder action pursuant to these bylaws and applicable law. For the avoidance of doubt, except for proposals properly made in accordance with Rule 14a-8 under the Securities and Exchange Act of 1934, as amended, or any successor thereto (the "**Exchange Act**"), and the regulations thereunder (or any successor rule and in any case as so amended), clause (C) above shall be the exclusive means for a stockholder to bring business before an annual meeting of stockholders.

(a) To comply with clause (C) of Section 2.4(i) above, a stockholder's notice must set forth all information required under this Section 2.4(i) and must be timely received by the secretary of the corporation. To be timely, a stockholder's notice must be received by the secretary at the principal executive offices of the corporation not later than the 45th day nor earlier than the 75th day before the one-year anniversary of the date on which the corporation first mailed its proxy materials or a notice of availability of proxy materials (whichever is earlier) for the preceding year's annual meeting; *provided, however*, that if no annual meeting was held in the previous year or if the date of the annual meeting is advanced by more than 30 days prior to or delayed by more than 60 days after the one-year anniversary of the date of the previous year's annual meeting, then, for notice by the stockholder to be timely, it must be so received by the secretary not earlier than the close of business on the 120th day prior to such annual meeting and not later than the close of business on the later of (i) the 90th day prior to such annual meeting or (ii) the tenth day following the day on which a Public Announcement (as defined below) of the date of such annual meeting is first made. In no event shall any adjournment, rescheduling or postponement of an annual meeting or the announcement thereof commence a new time period for the giving of a stockholder's notice as described in this Section 2.4(i) (a). "**Public Announcement**" shall mean disclosure in a press release reported by the Dow Jones News Service, Associated Press or a comparable national news service or in a document publicly filed by the corporation with the Securities and Exchange Commission pursuant to Section 13, 14 or 15(d) of the Exchange Act.

(b) To be in proper written form, a stockholder's notice to the secretary must set forth as to each matter of business the stockholder intends to bring before the annual meeting:

(1) a brief description of the business intended to be brought before the annual meeting and the reasons for conducting such business at the annual meeting;

(2) the text of the proposal or business (including the text of any resolutions proposed for consideration and in the event that such business includes a proposal to amend the bylaws of the corporation, the language of the proposed amendment);

(3) a reasonably detailed description of all agreements, arrangements and understandings between or among the stockholder and any Stockholder Associated Persons (as defined below) or between or among the stockholder or any Stockholder Associated Person and any other person or entity (including their names) in connection with the proposal of such business by such stockholder;

(4) the name and address, as they appear on the corporation's books, of the stockholder proposing such business and any Stockholder Associated Person;

(5) the class and number of shares of the corporation that are held of record or are beneficially owned (within the meaning of Rule 13d-3 under the Exchange Act) by the stockholder or any Stockholder Associated Person, except that the stockholder or any Stockholder Associated Person shall in all events be deemed to beneficially own any shares of any class or series of the corporation as to which such stockholder or Stockholder Associated Person has a right to acquire beneficial ownership at any time in the future;

(6) the full notional amount of any securities that, directly or indirectly, underlie any "derivative security" (as such term is defined in Rule 16a-1(c) under the Exchange Act) that constitutes a "call equivalent position" (as such term is defined in Rule 16a-1(b) under the Exchange Act) ("**Synthetic Equity Position**") and that is, directly or indirectly, held or maintained by such stockholder or any Stockholder Associated Person with respect to any shares of any class or series of shares of the corporation; provided that, for the purposes of the definition of "**Synthetic Equity Position**," the term "derivative security" shall also include any security or instrument that would not otherwise constitute a "derivative security" as a result of any feature that would make any conversion, exercise or similar right or privilege of such security or instrument becoming determinable only at some future date or upon the happening of a future occurrence, in which case the determination of the amount of securities into which such security or instrument would be convertible or exercisable shall be made assuming that such security or instrument is immediately convertible or exercisable at the time of such determination; and, provided, further, that a stockholder or Stockholder Associated Person satisfying the requirements of Rule 13d-1(b)(1) under the Exchange Act (other than a stockholder or Stockholder Associated Person that so satisfies Rule 13d-1(b)(1))

under the Exchange Act solely by reason of Rule 13d-1(b)(1)(ii)(E)) shall not be deemed to hold or maintain the notional amount of any securities that underlie a Synthetic Equity Position held by such stockholder or Stockholder Associated Person as a hedge with respect to a bona fide derivatives trade or position of such stockholder or Stockholder Associated Person arising in the ordinary course of such stockholder's or Stockholder Associated Person's business as a derivatives dealer;

(7) whether and the extent to which any hedging or other transaction or series of transactions has been entered into by or on behalf of such stockholder or any Stockholder Associated Person with respect to any securities of the corporation and a description of any other agreement, arrangement or understanding (including any short position or any borrowing or lending of shares), the effect or intent of which is to mitigate loss to, or to manage the risk or benefit from share price changes for, or to increase or decrease the voting power of, such stockholder or any Stockholder Associated Person with respect to any securities of the corporation;

(8) any rights to dividends on the shares of any class or series of shares of the corporation owned beneficially by such stockholder or any Stockholder Associated Person that are separated or separable from the underlying shares of the corporation;

(9) any material shares or any Synthetic Equity Position in any principal competitor of the corporation in any principal industry of the corporation held by such stockholder or any Stockholder Associated Person;

(10) any material interest of the stockholder or a Stockholder Associated Person in such business to be brought before the meeting;

(11) any material pending or threatened legal proceeding in which such stockholder or any Stockholder Associated Person is a party or material participant involving the corporation, or any of its officers or directors, or any affiliate of the corporation;

(12) any other material relationship between such stockholder or any Stockholder Associated Person, on the one hand, and the corporation, any affiliate of the corporation or any principal competitor of the corporation, on the other hand;

(13) any direct or indirect material interest in any material contract or agreement of such stockholder or any Stockholder Associated Person with the corporation, any affiliate of the corporation or any principal competitor of the corporation (including, in any such case, any employment agreement, collective bargaining agreement or consulting agreement);

(14) a statement whether either such stockholder or any Stockholder Associated Person will deliver a proxy statement and form of proxy to holders of at least the percentage of the voting power of the corporation's voting shares required under applicable law to carry the proposal; and

(15) any other information relating to such stockholder or any Stockholder Associated Person, or relating to the proposal or item of business, that would be required to be disclosed in a proxy statement or other filing required to be made in connection with solicitations of proxies or consents by such Proposing Person in support of the business proposed to be brought before the meeting pursuant to Section 14(a) of the Exchange Act (such information provided and statements made as required by clauses (1) through (15), a **“Business Solicitation Statement”**).

Provided, however, that a Business Solicitation Statement shall not include any such disclosures with respect to the ordinary course business activities of any broker, dealer, commercial bank, trust company or other nominee who is a Stockholder Associated Person solely as a result of being the stockholder directed to prepare and submit the notice required by these bylaws on behalf of a beneficial owner. In addition, to be in proper written form, a stockholder’s notice to the secretary must be supplemented (the **“Supplement”**) not later than ten days following the record date for the determination of stockholders entitled to notice of the meeting to disclose the information contained in clauses (5) through (8) above as of the record date for notice of the meeting. For purposes of this Section 2.4, a **“Stockholder Associated Person”** of any stockholder shall mean (i) any person controlling, directly or indirectly, or acting in concert with, such stockholder, (ii) any beneficial owner of shares of stock of the corporation owned of record or beneficially by such stockholder and on whose behalf the proposal or nomination, as the case may be, is being made, (iii) any participant (as defined in paragraphs (a)(ii)-(vi) of Instruction 3 to Item 4 of Schedule 14A) with such stockholder in such solicitation or (iv) any associate (within the meaning of Rule 12b-2 under the Exchange Act for the purposes of these bylaws) of or person controlling, controlled by or under common control with such person referred to in the preceding clauses (i), (ii) and (iii).

(c) Without exception, no business shall be conducted at any annual meeting except in accordance with the provisions set forth in this Section 2.4(i) and, if applicable, Section 2.4(ii). In addition, business proposed to be brought by a stockholder may not be brought before the annual meeting if such stockholder or a Stockholder Associated Person, as applicable, takes action contrary to the representations made in the Business Solicitation Statement applicable to such business or if the Business Solicitation Statement applicable to such business contains an untrue statement of a material fact or omits to state a material fact necessary to make the statements therein not misleading. The chairperson of the annual meeting shall, if the facts warrant, determine and declare at the annual meeting that business was not properly brought before the annual meeting and in accordance with the provisions of this Section 2.4(i), and, if the chairperson should so determine, he or she shall so declare at the annual meeting that any such business not properly brought before the annual meeting shall not be conducted.

(ii) *Advance Notice of Director Nominations at Annual Meetings.* Notwithstanding anything in these bylaws to the contrary, only persons who are nominated in accordance with the procedures set forth in this Section 2.4(ii) shall be eligible for election or re-election as directors at an annual meeting of stockholders. Nominations of persons for election to the board of directors of the corporation shall be made at an annual meeting of stockholders only (A) by or at the direction of the board of directors or (B) by a stockholder of the corporation who

(1) was a stockholder of record at the time of the giving of the notice required by this Section 2.4(ii) and on the record date for the determination of stockholders entitled to vote at the annual meeting; and

(2) has complied with the notice procedures set forth in this Section 2.4(ii). In addition to any other applicable requirements, for a nomination to be made by a stockholder, the stockholder must have given timely notice thereof in proper written form to the secretary of the corporation.

(b) To comply with clause (B) of Section 2.4(ii) above, a nomination to be made by a stockholder must set forth all information required under this Section 2.4(ii) and must be received by the secretary of the corporation at the principal executive offices of the corporation at the time set forth in, and in accordance with, the second sentence of Section 2.4(i)(a) above; provided additionally, however, that if the number of directors to be elected to the board of directors is increased and there is no Public Announcement naming all of the nominees for director or specifying the size of the increased board made by the corporation at least ten days before the last day a stockholder may deliver a notice of nomination pursuant to the foregoing provisions, a stockholder's notice required by this Section 2.4(ii) shall also be considered timely, but only with respect to nominees for any new positions created by such increase, if it shall be received by the secretary of the corporation at the principal executive offices of the corporation not later than the close of business on the tenth day following the day on which such Public Announcement is first made by the corporation.

(c) To be in proper written form, such stockholder's notice to the secretary must set forth:

(1) as to each person (a "**nominee**") whom the stockholder proposes to nominate for election or re-election as a director: (A) the name, age, business address and residence address of the nominee, (B) the principal occupation or employment of the nominee, (C) the class and number of shares of the corporation that are held of record or are beneficially owned by the nominee and any derivative positions held or beneficially held by the nominee, (D) whether and the extent to which any hedging or other transaction or series of transactions has been entered into by or on behalf of the nominee with respect to any securities of the corporation and a description of any other agreement, arrangement or understanding (including any short position or any borrowing or lending of shares), the effect or intent of which is to mitigate loss to, or to manage the risk or benefit of share price changes for, or to increase or decrease the voting power of the nominee, (E) a description of all arrangements or understandings between or among any of the stockholder, each nominee and/or any other person or persons (naming such person or persons) pursuant to which the nominations are to be made by the stockholder or relating to the nominee's potential service on the board of directors, (F) a written statement executed by the nominee agreeing to serve as a director if elected and acknowledging that as a director of the corporation, the nominee will owe a

fiduciary duty under Delaware law with respect to the corporation and its stockholders and (G) any other information relating to the nominee that would be required to be disclosed about such nominee if proxies were being solicited for the election of the nominee as a director, or that is otherwise required, in each case pursuant to Regulation 14A under the Exchange Act (including without limitation the nominee's written consent to being named in the proxy statement, if any, as a nominee and to serving as a director if elected); and

(2) as to such stockholder giving notice, (A) the information required to be provided pursuant to clauses (3) through (15) of Section 2.4(i)(b) above, and the Supplement referenced in Section 2.4(i)(b) above (except that the references to "business" in such clauses shall instead refer to nominations of directors for purposes of this paragraph), and (B) a statement whether either such stockholder or Stockholder Associated Person will deliver a proxy statement and form of proxy to holders of at least the percentage of the voting power of the corporation's voting shares reasonably believed by such stockholder or Stockholder Associated Person to be necessary to elect such nominee(s) (such information provided and statements made as required by clauses (A) through (G) of Section 2.4(ii)(b)(1) and clauses (A) and (B) of this Section 2.4(ii)(b)(2) above, a "**Nominee Solicitation Statement**").

(d) At the request of the board of directors, any person nominated by a stockholder for election as a director must furnish to the secretary of the corporation (1) that information required to be set forth in the stockholder's notice of nomination of such person as a director as of a date subsequent to the date on which the notice of such person's nomination was given, (2) such other information as may reasonably be required by the corporation to determine the eligibility of such proposed nominee to serve as an independent director or audit committee financial expert of the corporation under applicable law, securities exchange rule or regulation or any publicly-disclosed corporate governance guideline or committee charter of the corporation and (3) such other information that could be material to a reasonable stockholder's understanding of the independence, or lack thereof, of such nominee; in the absence of the furnishing of such information if requested, such stockholder's nomination shall not be considered in proper form pursuant to this Section 2.4(ii).

(e) Without exception, no person shall be eligible for election or re-election as a director of the corporation at an annual meeting of stockholders unless nominated in accordance with the provisions set forth in this Section 2.4(ii). In addition, a nominee shall not be eligible for election or re-election if a stockholder or Stockholder Associated Person, as applicable, takes action contrary to the representations made in the Nominee Solicitation Statement applicable to such nominee or if the Nominee Solicitation Statement applicable to such nominee contains an untrue statement of a material fact or omits to state a material fact necessary to make the statements therein not misleading. The chairperson of the annual meeting shall, if the facts warrant, determine and declare at the annual meeting that a nomination was not made in accordance with the provisions prescribed by these bylaws, and if the chairperson should so determine, he or she shall so declare at the annual meeting, and the defective nomination shall be disregarded.

(iii) *Advance Notice of Director Nominations for Special Meetings.*

(a) For a special meeting of stockholders at which directors are to be elected pursuant to Section 2.3, nominations of persons for election to the board of directors shall be made only (1) by or at the direction of the board of directors or (2) by any stockholder of the corporation who (A) is a stockholder of record at the time of the giving of the notice required by this Section 2.4(iii) and on the record date for the determination of stockholders entitled to vote at the special meeting and (B) delivers a timely written notice of the nomination to the secretary of the corporation that includes the information set forth in Sections 2.4(ii)(b) and (ii)(c) above. To be timely, such notice must be received by the secretary at the principal executive offices of the corporation not later than the close of business on the later of the 90th day prior to such special meeting or the tenth day following the day on which Public Announcement is first made of the date of the special meeting and of the nominees proposed by the board of directors to be elected at such meeting. In no event shall any adjournment, rescheduling or postponement of a special meeting or the announcement thereof commence a new time period for the giving of a stockholder's notice. A person shall not be eligible for election or re-election as a director at a special meeting unless the person is nominated (i) by or at the direction of the board of directors or (ii) by a stockholder in accordance with the notice procedures set forth in this Section 2.4(iii). In addition, a nominee shall not be eligible for election or re-election if a stockholder or Stockholder Associated Person, as applicable, takes action contrary to the representations made in the Nominee Solicitation Statement applicable to such nominee or if the Nominee Solicitation Statement applicable to such nominee contains an untrue statement of a material fact or omits to state a material fact necessary to make the statements therein not misleading.

(b) The chairperson of the special meeting shall, if the facts warrant, determine and declare at the meeting that a nomination or business was not made in accordance with the procedures prescribed by these bylaws, and if the chairperson should so determine, he or she shall so declare at the meeting, and the defective nomination or business shall be disregarded.

(iv) *Other Requirements and Rights.* In addition to the foregoing provisions of this Section 2.4, a stockholder must also comply with all applicable requirements of state law and of the Exchange Act and the rules and regulations thereunder with respect to the matters set forth in this Section 2.4, including, with respect to business such stockholder intends to bring before the annual meeting that involves a proposal that such stockholder requests to be included in the corporation's proxy statement, the requirements of Rule 14a-8 (or any successor provision) under the Exchange Act. Nothing in this Section 2.4 shall be deemed to affect any right of the corporation to omit a proposal from the corporation's proxy statement pursuant to Rule 14a-8 (or any successor provision) under the Exchange Act.

## 2.5 NOTICE OF STOCKHOLDERS' MEETINGS

Whenever stockholders are required or permitted to take any action at a meeting, a written notice of the meeting shall be given which shall state the place, if any, date and hour of the meeting, the means of remote communications, if any, by which stockholders and proxy holders may be deemed to be present in person and vote at such meeting, the record date for determining the stockholders entitled to vote at the meeting, if such date is different from the record date for determining stockholders entitled to notice of the meeting, and, in the case of a special meeting, the purpose or purposes for which the meeting is called. Except as otherwise provided in the DGCL, the certificate of incorporation or these bylaws, the written notice of any meeting of stockholders shall be given not less than ten nor more than 60 days before the date of the meeting to each stockholder entitled to vote at such meeting as of the record date for determining the stockholders entitled to notice of the meeting.

## 2.6 QUORUM

The holders of a majority of the voting power of the stock issued and outstanding and entitled to vote, present in person or represented by proxy, shall constitute a quorum for the transaction of business at all meetings of the stockholders, unless otherwise required by law, the certificate of incorporation, these bylaws or the rules of any applicable stock exchange. Where a separate vote by a class or series or classes or series is required, a majority of the voting power of the issued and outstanding shares of such class or series or classes or series, present in person or represented by proxy, shall constitute a quorum entitled to take action with respect to that vote on that matter, except as otherwise required by law, the certificate of incorporation, these bylaws or the rules of any applicable stock exchange.

Whether or not a quorum is present at a meeting of stockholders, the chairperson of the meeting shall have the power to adjourn the meeting from time to time, without notice other than announcement at the meeting. At such adjourned meeting at which a quorum is present or represented, any business may be transacted that might have been transacted at the original meeting.

## 2.7 ADJOURNED MEETING; NOTICE

When a meeting is adjourned to another time or place, unless these bylaws otherwise require, notice need not be given of the adjourned meeting if the time, place, if any, thereof, and the means of remote communications, if any, by which stockholders and proxy holders may be deemed to be present in person and vote at such adjourned meeting are announced at the meeting at which the adjournment is taken. At the adjourned meeting, the corporation may transact any business which might have been transacted at the original meeting. If the adjournment is for more than 30 days, a notice of the adjourned meeting shall be given to each stockholder of record entitled to vote at the meeting. If after the adjournment a new record date for stockholders entitled to vote is fixed for the adjourned meeting, the board of directors shall fix a new record date for notice of such adjourned meeting in accordance with Section 213(a) of the DGCL and Section 2.11 of these bylaws and shall give notice of the adjourned meeting to each stockholder of record entitled to vote at such adjourned meeting as of the record date fixed for notice of such adjourned meeting.



## 2.8 CONDUCT OF BUSINESS

The chairperson of any meeting of stockholders shall determine the order of business and the procedure at the meeting, including such regulation of the manner of voting and the conduct of business. The chairperson of any meeting of stockholders shall be designated by the board of directors; in the absence of such designation, the chairperson of the board, if any, the chief executive officer (in the absence of the chairperson) or the president (in the absence of the chairperson of the board and the chief executive officer), or in their absence any other executive officer of the corporation, shall serve as chairperson of the stockholder meeting. The chairperson of any stockholder meeting shall have the power to adjourn the meeting to another place, if any, date or time.

## 2.9 VOTING

The stockholders entitled to vote at any meeting of stockholders shall be determined in accordance with the provisions of Section 2.11 of these bylaws, subject to Section 217 (relating to voting rights of fiduciaries, pledgors and joint owners of stock) and Section 218 (relating to voting trusts and other voting agreements) of the DGCL.

Except as may be otherwise provided in the certificate of incorporation, each stockholder shall be entitled to one vote for each share of capital stock held by such stockholder.

Except as otherwise provided by law, the certificate of incorporation, these bylaws or the rules of any applicable stock exchange, in all matters other than the election of directors, the affirmative vote of a majority of the voting power of the shares present in person or represented by proxy at the meeting and entitled to vote on the subject matter shall be the act of the stockholders. Except as otherwise required by law, the certificate of incorporation, these bylaws or the rules of any applicable stock exchange, directors shall be elected by a plurality of the voting power of the shares present in person or represented by proxy at the meeting and entitled to vote on the election of directors. Where a separate vote by a class or series or classes or series is required, in all matters other than the election of directors, the affirmative vote of the majority of the voting power of shares of such class or series or classes or series present in person or represented by proxy at the meeting shall be the act of such class or series or classes or series, except as otherwise provided by law, the certificate of incorporation, these bylaws or the rules of any applicable stock exchange.

## 2.10 STOCKHOLDER ACTION BY WRITTEN CONSENT WITHOUT A MEETING

Subject to the rights of the holders of the shares of any series of preferred stock or any other class of stock or series thereof that have been expressly granted the right to take action by written consent, any action required or permitted to be taken by the stockholders of the corporation must be effected at a duly called annual or special meeting of stockholders of the corporation and may not be effected by any consent in writing by such stockholders; provided, however, that this Section 2.10 shall only apply on and after the first date on which a registration statement on Form S-1 filed by the corporation with the Securities and Exchange Commission is declared effective by the Securities and Exchange Commission.

## 2.11 RECORD DATES

In order that the corporation may determine the stockholders entitled to notice of any meeting of stockholders or any adjournment thereof, the board of directors may fix a record date, which record date shall not precede the date upon which the resolution fixing the record date is adopted by the board of directors and which record date shall not be more than 60 nor less than ten days before the date of such meeting. If the board of directors so fixes a date, such date shall also be the record date for determining the stockholders entitled to vote at such meeting unless the board of directors determines, at the time it fixes such record date, that a later date on or before the date of the meeting shall be the date for making such determination.

If no record date is fixed by the board of directors, the record date for determining stockholders entitled to notice of and to vote at a meeting of stockholders shall be at the close of business on the day next preceding the day on which notice is given, or, if notice is waived, at the close of business on the day next preceding the day on which the meeting is held.

A determination of stockholders of record entitled to notice of or to vote at a meeting of stockholders shall apply to any adjournment of the meeting; *provided, however*, that the board of directors may fix a new record date for determination of stockholders entitled to vote at the adjourned meeting, and in such case shall also fix as the record date for stockholders entitled to notice of such adjourned meeting the same or an earlier date as that fixed for determination of stockholders entitled to vote in accordance with the provisions of Section 213 of the DGCL and this Section 2.11 at the adjourned meeting.

In order that the corporation may determine the stockholders entitled to receive payment of any dividend or other distribution or allotment of any rights or the stockholders entitled to exercise any rights in respect of any change, conversion or exchange of stock or for the purpose of any other lawful action, the board of directors may fix a record date, which record date shall not precede the date upon which the resolution fixing the record date is adopted, and which record date shall be not more than 60 days prior to such action. If no record date is fixed, the record date for determining stockholders for any such purpose shall be at the close of business on the day on which the board of directors adopts the resolution relating thereto.

## 2.12 PROXIES

Each stockholder entitled to vote at a meeting of stockholders may authorize another person or persons to act for such stockholder by proxy authorized by an instrument in writing or by a transmission permitted by law filed in accordance with the procedure established for the meeting, but no such proxy shall be voted or acted upon after three years from its date, unless the proxy provides for a longer period. The revocability of a proxy that states on its face that it is irrevocable shall be governed by the provisions of Section 212 of the DGCL. A written proxy may be given by electronic transmission which sets forth or is submitted with information from which it can be determined that the electronic transmission was authorized by the stockholder.

## 2.13 LIST OF STOCKHOLDERS ENTITLED TO VOTE

The officer who has charge of the stock ledger of the corporation shall prepare and make, at least ten days before every meeting of stockholders, a complete list of the stockholders entitled to vote at the meeting; *provided, however*, that if the record date for determining the stockholders entitled to vote is less than ten days before the meeting date, the list shall reflect the stockholders entitled to vote as of the tenth day before the meeting date, arranged in alphabetical order, and showing the address of each stockholder and the number of shares registered in the name of each stockholder. The corporation shall not be required to include electronic mail addresses or other electronic contact information on such list. Such list shall be open to the examination of any stockholder for any purpose germane to the meeting for a period of at least ten days prior to the meeting: (i) on a reasonably accessible electronic network, *provided* that the information required to gain access to such list is provided with the notice of the meeting, or (ii) during ordinary business hours, at the corporation's principal place of business. If the corporation determines to make the list available on an electronic network, the corporation may take reasonable steps to ensure that such information is available only to stockholders of the corporation. If the meeting is to be held at a place, then a list of stockholders entitled to vote at the meeting shall be produced and kept at the time and place of the meeting during the whole time thereof, and may be examined by any stockholder who is present. If the meeting is to be held solely by means of remote communication, then such list shall also be open to the examination of any stockholder during the whole time of the meeting on a reasonably accessible electronic network, and the information required to access such list shall be provided with the notice of the meeting. Except as otherwise provided by law, the stock ledger of the corporation shall be the only evidence as to the identity of the stockholders entitled to examine the list of stockholders required by this Section 2.13 or to vote at any meeting of stockholders.

## 2.14 INSPECTORS OF ELECTION

Before any meeting of stockholders, the board of directors shall appoint an inspector or inspectors of election to act at the meeting or its adjournment. The number of inspectors shall be either one (1) or three (3). If any person appointed as inspector fails to appear or fails or refuses to act, then the chairperson of the meeting may, and upon the request of any stockholder or a stockholder's proxy shall, appoint a person to fill that vacancy; *provided further* that, in any case, if no inspector or alternate is able to act at a meeting of stockholders, the chairperson of the meeting shall appoint at least one (1) inspector to act at the meeting.

Each inspector, before entering upon the discharge of his or her duties, shall take and sign an oath to execute faithfully the duties of inspector with strict impartiality and according to the best of his or her ability. Such inspectors shall take all actions as contemplated under Section 231 of the DGCL.

The inspectors of election shall perform their duties impartially, in good faith, to the best of their ability and as expeditiously as is practical. If there are three (3) inspectors of election, the decision, act or certificate of a majority is effective in all respects as the decision, act or certificate of all. Any report or certificate made by the inspectors of election is *prima facie* evidence of the facts stated therein.

**ARTICLE III  
DIRECTORS**

**3.1 POWERS**

The business and affairs of the corporation shall be managed by or under the direction of the board of directors, except as may be otherwise provided in the DGCL or the certificate of incorporation.

**3.2 NUMBER OF DIRECTORS**

The board of directors shall consist of one or more members, each of whom shall be a natural person. Unless the certificate of incorporation fixes the number of directors, the number of directors shall be determined from time to time by resolution of the board of directors. No reduction of the authorized number of directors shall have the effect of removing any director before that director's term of office expires.

**3.3 ELECTION, QUALIFICATION AND TERM OF OFFICE OF DIRECTORS**

Except as provided in Section 3.4 of these bylaws, each director, including a director elected to fill a vacancy or newly created directorship, shall hold office until the expiration of the term for which elected and until such director's successor is elected and qualified or until such director's earlier death, resignation or removal. Directors need not be stockholders unless so required by the certificate of incorporation or these bylaws. The certificate of incorporation or these bylaws may prescribe other qualifications for directors.

In accordance with the provisions of the certificate of incorporation, the directors of the corporation shall be divided into three classes.

**3.4 RESIGNATION AND VACANCIES**

Any director may resign at any time upon notice given in writing or by electronic transmission to the corporation; provided, however, that if such notice is given by electronic transmission, such electronic transmission must either set forth or be submitted with information from which it can be determined that the electronic transmission was authorized by the director. A resignation is effective when the resignation is delivered unless the resignation specifies a later effective date or an effective date is determined upon the happening of an event or events. Unless otherwise specified in the notice of resignation, acceptance of such resignation shall not be necessary to make it effective. A resignation which is conditioned upon the director failing to receive a specified vote for reelection as a director may provide that it is irrevocable. Unless otherwise provided in the certificate of incorporation or these bylaws, when one or more directors resign from the board of directors, effective at a future date, a majority of the directors then in office, including those who have so resigned, shall have the power to fill such vacancy or vacancies, the vote thereon to take effect when such resignation or resignations shall become effective.

Unless otherwise provided in the certificate of incorporation or these bylaws or permitted in the specific case by resolution of the board of directors, and subject to the rights (if any) of holders of preferred stock, vacancies and newly created directorships resulting from any increase in the authorized number of directors elected by all of the stockholders having the right to vote as a single class shall be filled only by a majority of the directors then in office, although less than a quorum, or by a sole remaining director, and not by stockholders. If the directors are divided into classes, a person so chosen to fill a vacancy or newly created directorship shall hold office until the next election of the class for which such director shall have been chosen and until his or her successor shall have been duly elected and qualified.

### 3.5 PLACE OF MEETINGS; MEETINGS BY TELEPHONE

The board of directors may hold meetings, both regular and special, either within or outside the State of Delaware.

Unless otherwise restricted by the certificate of incorporation or these bylaws, members of the board of directors, or any committee designated by the board of directors, may participate in a meeting of the board of directors, or any committee, by means of conference telephone or other communications equipment by means of which all persons participating in the meeting can hear each other, and such participation in a meeting shall constitute presence in person at the meeting.

### 3.6 REGULAR MEETINGS

Regular meetings of the board of directors may be held without notice at such time and at such place as shall from time to time be determined by the board of directors.

### 3.7 SPECIAL MEETINGS; NOTICE

Special meetings of the board of directors for any purpose or purposes may be called at any time by the chairperson of the board of directors, the chief executive officer, the president, the secretary or a majority of the authorized number of directors, at such times and places as he or she or they shall designate.

Notice of the time and place of special meetings shall be:

- (i) delivered personally by hand, by courier or by telephone;
- (ii) sent by United States first-class mail, postage prepaid;
- (iii) sent by facsimile; or
- (iv) sent by electronic mail,

directed to each director at that director's address, telephone number, facsimile number or electronic mail address, as the case may be, as shown on the corporation's records.

If the notice is (i) delivered personally by hand, by courier or by telephone, (ii) sent by facsimile or (iii) sent by electronic mail, it shall be delivered or sent at least 24 hours before the time of the holding of the meeting. If the notice is sent by United States mail, it shall be deposited

in the United States mail at least four days before the time of the holding of the meeting. Any oral notice may be communicated to the director. The notice need not specify the place of the meeting (if the meeting is to be held at the corporation's principal executive office) nor the purpose of the meeting.

### 3.8 QUORUM; VOTING

At all meetings of the board of directors, a majority of the total authorized number of directors shall constitute a quorum for the transaction of business. If a quorum is not present at any meeting of the board of directors, then the directors present thereat may adjourn the meeting from time to time, without notice other than announcement at the meeting, until a quorum is present.

The vote of a majority of the directors present at any meeting at which a quorum is present shall be the act of the board of directors, except as may be otherwise specifically provided by statute, the certificate of incorporation or these bylaws.

If the certificate of incorporation provides that one or more directors shall have more or less than one vote per director on any matter, every reference in these bylaws to a majority or other proportion of the directors shall refer to a majority or other proportion of the votes of the directors.

### 3.9 BOARD ACTION BY WRITTEN CONSENT WITHOUT A MEETING

Unless otherwise restricted by the certificate of incorporation or these bylaws, any action required or permitted to be taken at any meeting of the board of directors, or of any committee thereof, may be taken without a meeting if all members of the board of directors or committee, as the case may be, consent thereto in writing or by electronic transmission and the writing or writings or electronic transmission or transmissions are filed with the minutes of proceedings of the board of directors or committee. Such filing shall be in paper form if the minutes are maintained in paper form and shall be in electronic form if the minutes are maintained in electronic form. Any person (whether or not then a director) may provide, whether through instruction to an agent or otherwise, that a consent to action will be effective at a future time (including a time determined upon the happening of an event), no later than 60 days after such instruction is given or such provision is made and such consent shall be deemed to have been given for purposes of this Section 3.9 at such effective time so long as such person is then a director and did not revoke the consent prior to such time. Any such consent shall be revocable prior to its becoming effective.

### 3.10 FEES AND COMPENSATION OF DIRECTORS

Unless otherwise restricted by the certificate of incorporation or these bylaws, the board of directors shall have the authority to fix the compensation of directors.

### 3.11 REMOVAL OF DIRECTORS

Unless otherwise provided in the certificate of incorporation, any director may be removed from office by the stockholders of the corporation only for cause.

No reduction of the authorized number of directors shall have the effect of removing any director prior to the expiration of such director's term of office.

**ARTICLE IV  
COMMITTEES**

**4.1 COMMITTEES OF DIRECTORS**

The board of directors may designate one or more committees, each committee to consist of one or more of the directors of the corporation. The board of directors may designate one or more directors as alternate members of any committee, who may replace any absent or disqualified member at any meeting of the committee. In the absence or disqualification of a member of a committee, the member or members thereof present at any meeting and not disqualified from voting, whether or not such member or members constitute a quorum, may unanimously appoint another member of the board of directors to act at the meeting in the place of any such absent or disqualified member. Any such committee, to the extent provided in the resolution of the board of directors or in these bylaws, shall have and may exercise all the powers and authority of the board of directors in the management of the business and affairs of the corporation, and may authorize the seal of the corporation to be affixed to all papers that may require it; but no such committee shall have the power or authority to (i) approve or adopt, or recommend to the stockholders, any action or matter (other than the election or removal of directors) expressly required by the DGCL to be submitted to stockholders for approval, or (ii) adopt, amend or repeal any bylaw of the corporation.

**4.2 COMMITTEE MINUTES**

Each committee shall keep regular minutes of its meetings and report the same to the board of directors when required.

**4.3 MEETINGS AND ACTION OF COMMITTEES**

Meetings and actions of committees shall be governed by, and held and taken in accordance with, the provisions of:

- (i) Section 3.5 (place of meetings and meetings by telephone);
- (ii) Section 3.6 (regular meetings);
- (iii) Section 3.7 (special meetings; notice);
- (iv) Section 3.8 (quorum; voting);
- (v) Section 7.5 (waiver of notice); and
- (vi) Section 3.9 (board action by written consent without a meeting)

with such changes in the context of those bylaws as are necessary to substitute the committee and its members for the board of directors and its members. However:

- (i) the time of regular meetings of committees may be determined either by resolution of the board of directors or by resolution of the committee;

(ii) special meetings of committees may also be called by resolution of the board of directors; and

(iii) notice of special meetings of committees shall also be given to all alternate members, who shall have the right to attend all meetings of the committee. The board of directors or a committee may adopt rules for the government of any committee not inconsistent with the provisions of these bylaws.

Any provision in the certificate of incorporation providing that one or more directors shall have more or less than one vote per director on any matter shall apply to voting in any committee or subcommittee, unless otherwise provided in the certificate of incorporation or these bylaws.

#### 4.4 SUBCOMMITTEES

Unless otherwise provided in the certificate of incorporation, these bylaws or the resolutions of the board of directors designating the committee, a committee may create one or more subcommittees, each subcommittee to consist of one or more members of the committee, and delegate to a subcommittee any or all of the powers and authority of the committee.

### **ARTICLE V OFFICERS**

#### 5.1 OFFICERS

The officers of the corporation shall be a president and a secretary. The corporation may also have, at the discretion of the board of directors, a chairperson of the board of directors, a vice chairperson of the board of directors, a chief executive officer, a chief financial officer or treasurer, one or more vice presidents, one or more assistant vice presidents, one or more assistant treasurers, one or more assistant secretaries, and any such other officers as may be appointed in accordance with the provisions of these bylaws or otherwise determined by the board of directors. Any number of offices may be held by the same person.

#### 5.2 APPOINTMENT OF OFFICERS

The board of directors shall appoint the officers of the corporation, except such officers as may be appointed in accordance with the provisions of Sections 5.3 of these bylaws, subject to the rights, if any, of an officer under any contract of employment.

#### 5.3 SUBORDINATE OFFICERS

The board of directors may appoint, or empower the chief executive officer or, in the absence of a chief executive officer, the president, to appoint, such other officers and agents as the business of the corporation may require. Each of such officers and agents shall hold office for such period, have such authority, and perform such duties as are provided in these bylaws or as the board of directors may from time to time determine.



#### 5.4 REMOVAL AND RESIGNATION OF OFFICERS

Subject to the rights, if any, of an officer under any contract of employment, any officer may be removed, either with or without cause, by the board of directors or, except in the case of an officer chosen by the board of directors unless otherwise provided by resolution of the board of directors, by any officer upon whom such power of removal may be conferred by the board of directors.

Any officer may resign at any time by giving written notice to the corporation. Any resignation shall take effect at the date of the receipt of that notice or at any later time specified in that notice. Unless otherwise specified in the notice of resignation, the acceptance of the resignation shall not be necessary to make it effective. Any resignation is without prejudice to the rights, if any, of the corporation under any contract to which the officer is a party.

#### 5.5 VACANCIES IN OFFICES

Any vacancy occurring in any office of the corporation shall be filled by the board of directors or as provided in Section 5.3.

#### 5.6 REPRESENTATION OF SHARES OF OTHER ENTITIES

The chairperson of the board of directors, the chief executive officer, the president, any vice president, the treasurer, the secretary or assistant secretary of this corporation, or any other person authorized by the board of directors or the chief executive officer, the president or a vice president, is authorized to vote, represent, and exercise on behalf of this corporation all rights incident to any and all shares or other equity interests of any other corporation or corporations or entity or entities standing in the name of this corporation, including the right to act by written consent. The authority granted herein may be exercised either by such person directly or by any other person authorized to do so by proxy or power of attorney duly executed by such person having the authority.

#### 5.7 AUTHORITY AND DUTIES OF OFFICERS

All officers of the corporation shall respectively have such authority and perform such duties in the management of the business of the corporation as may be designated from time to time by the board of directors and, to the extent not so provided, as generally pertain to their respective offices, subject to the control of the board of directors.

### **ARTICLE VI STOCK**

#### 6.1 STOCK CERTIFICATES; PARTLY PAID SHARES

The shares of the corporation shall be represented by certificates, provided that the board of directors may provide by resolution or resolutions that some or all of any or all classes or series of its stock shall be uncertificated shares. Any such resolution shall not apply to shares represented by a certificate until such certificate is surrendered to the corporation. Every holder of stock represented by certificates shall be entitled to have a certificate signed by, or in the name of, the

corporation by the chairperson of the board of directors or vice-chairperson of the board of directors, or the chief executive officer, president or a vice-president, and by the treasurer or an assistant treasurer, or the secretary or an assistant secretary of the corporation representing the number of shares registered in certificate form. Any or all of the signatures on the certificate may be a facsimile. In case any officer, transfer agent or registrar who has signed or whose facsimile signature has been placed upon a certificate has ceased to be such officer, transfer agent or registrar before such certificate is issued, it may be issued by the corporation with the same effect as if such person were such officer, transfer agent or registrar at the date of issue. The corporation shall not have power to issue a certificate in bearer form.

The corporation may issue the whole or any part of its shares as partly paid and subject to call for the remainder of the consideration to be paid therefor. Upon the face or back of each stock certificate issued to represent any such partly-paid shares, or upon the books and records of the corporation in the case of uncertificated partly-paid shares, the total amount of the consideration to be paid therefor and the amount paid thereon shall be stated. Upon the declaration of any dividend on fully-paid shares, the corporation shall declare a dividend upon partly-paid shares of the same class, but only upon the basis of the percentage of the consideration actually paid thereon.

## 6.2 SPECIAL DESIGNATION ON CERTIFICATES

If the corporation is authorized to issue more than one class of stock or more than one series of any class, then the powers, the designations, the preferences, and the relative, participating, optional or other special rights of each class of stock or series thereof and the qualifications, limitations or restrictions of such preferences and/or rights shall be set forth in full or summarized on the face or back of the certificate that the corporation shall issue to represent such class or series of stock; *provided, however*, that, except as otherwise provided in Section 202 of the DGCL, in lieu of the foregoing requirements there may be set forth on the face or back of the certificate that the corporation shall issue to represent such class or series of stock, a statement that the corporation will furnish without charge to each stockholder who so requests the powers, designations, preferences and relative, participating, optional or other special rights of each class of stock or series thereof and the qualifications, limitations or restrictions of such preferences and/or rights. Within a reasonable time after the issuance or transfer of uncertificated stock, the corporation shall send to the registered owner thereof a written notice containing the information required to be set forth or stated on certificates pursuant to this Section 6.2 or Sections 151, 156, 202(a) or 218(a) of the DGCL or with respect to this Section 6.2 a statement that the corporation will furnish without charge to each stockholder who so requests the powers, designations, preferences and relative, participating, optional or other special rights of each class of stock or series thereof and the qualifications, limitations or restrictions of such preferences and/or rights. Except as otherwise expressly provided by law, the rights and obligations of the holders of uncertificated stock and the rights and obligations of the holders of certificates representing stock of the same class and series shall be identical.

## 6.3 LOST CERTIFICATES

Except as provided in this Section 6.3, no new certificates for shares shall be issued to replace a previously issued certificate unless the latter is surrendered to the corporation and cancelled at the same time. The corporation may issue a new certificate of stock or uncertificated

shares in the place of any certificate theretofore issued by it, alleged to have been lost, stolen or destroyed, and the corporation may require the owner of the lost, stolen or destroyed certificate, or such owner's legal representative, to give the corporation a bond, in such sum as the corporation may direct, sufficient to indemnify it against any claim that may be made against it on account of the alleged loss, theft or destruction of any such certificate or the issuance of such new certificate or uncertificated shares.

#### 6.4 DIVIDENDS

The board of directors, subject to any restrictions contained in the certificate of incorporation or applicable law, may declare and pay dividends upon the shares of the corporation's capital stock. Dividends may be paid in cash, in property, or in shares of the corporation's capital stock, subject to the provisions of the certificate of incorporation.

The board of directors may set apart out of any of the funds of the corporation available for dividends a reserve or reserves for any proper purpose and may abolish any such reserve. Such purposes shall include but not be limited to equalizing dividends, repairing or maintaining any property of the corporation and meeting contingencies.

#### 6.5 TRANSFER OF STOCK

Transfers of record of shares of stock of the corporation shall be made only upon its books by the holders thereof, in person or by an attorney duly authorized, and, subject to Section 6.3 of these bylaws, if such stock is certificated, upon the surrender of a certificate or certificates for a like number of shares, properly endorsed or accompanied by proper evidence of succession, assignation or authority to transfer.

#### 6.6 STOCK TRANSFER AGREEMENTS

The corporation shall have power to enter into and perform any agreement with any number of stockholders of any one or more classes of stock of the corporation to restrict the transfer of shares of stock of the corporation of any one or more classes owned by such stockholders in any manner not prohibited by the DGCL.

#### 6.7 REGISTERED STOCKHOLDERS

The corporation:

- (i) shall be entitled to recognize the exclusive right of a person registered on its books as the owner of shares to receive dividends and to vote as such owner;
- (ii) shall be entitled to hold liable for calls and assessments the person registered on its books as the owner of shares; and
- (iii) shall not be bound to recognize any equitable or other claim to or interest in such share or shares on the part of another person, whether or not it shall have express or other notice thereof, except as otherwise provided by the laws of Delaware.

**ARTICLE VII**  
**MANNER OF GIVING NOTICE AND WAIVER**

**7.1 NOTICE OF STOCKHOLDERS' MEETINGS**

Notice of any meeting of stockholders, if mailed, is given when deposited in the United States mail, postage prepaid, directed to the stockholder at such stockholder's address as it appears on the corporation's records. An affidavit of the secretary or an assistant secretary of the corporation or of the transfer agent or other agent of the corporation that the notice has been given shall, in the absence of fraud, be *prima facie* evidence of the facts stated therein.

**7.2 NOTICE BY ELECTRONIC TRANSMISSION**

Without limiting the manner by which notice otherwise may be given effectively to stockholders pursuant to the DGCL, the certificate of incorporation or these bylaws, any notice to stockholders given by the corporation under any provision of the DGCL, the certificate of incorporation or these bylaws shall be effective if given by a form of electronic transmission consented to by the stockholder to whom the notice is given. Any such consent shall be revocable by the stockholder by written notice to the corporation. Any such consent shall be deemed revoked if:

(i) the corporation is unable to deliver by electronic transmission two consecutive notices given by the corporation in accordance with such consent; and

(ii) such inability becomes known to the secretary or an assistant secretary of the corporation or to the transfer agent, or other person responsible for the giving of notice.

However, the inadvertent failure to treat such inability as a revocation shall not invalidate any meeting or other action.

Any notice given pursuant to the preceding paragraph shall be deemed given:

(i) if by facsimile telecommunication, when directed to a number at which the stockholder has consented to receive notice;

(ii) if by electronic mail, when directed to an electronic mail address at which the stockholder has consented to receive notice;

(iii) if by a posting on an electronic network together with separate notice to the stockholder of such specific posting, upon the later of (A) such posting and (B) the giving of such separate notice; and

(iv) if by any other form of electronic transmission, when directed to the stockholder.

An affidavit of the secretary or an assistant secretary or of the transfer agent or other agent of the corporation that the notice has been given by a form of electronic transmission shall, in the absence of fraud, be *prima facie* evidence of the facts stated therein.

An “**electronic transmission**” means any form of communication, not directly involving the physical transmission of paper, that creates a record that may be retained, retrieved, and reviewed by a recipient thereof, and that may be directly reproduced in paper form by such a recipient through an automated process.

### 7.3 NOTICE TO STOCKHOLDERS SHARING AN ADDRESS

Except as otherwise prohibited under the DGCL, without limiting the manner by which notice otherwise may be given effectively to stockholders, any notice to stockholders given by the corporation under the provisions of the DGCL, the certificate of incorporation or these bylaws shall be effective if given by a single written notice to stockholders who share an address if consented to by the stockholders at that address to whom such notice is given. Any such consent shall be revocable by the stockholder by written notice to the corporation. Any stockholder who fails to object in writing to the corporation, within 60 days of having been given written notice by the corporation of its intention to send the single notice, shall be deemed to have consented to receiving such single written notice.

### 7.4 NOTICE TO PERSON WITH WHOM COMMUNICATION IS UNLAWFUL

Whenever notice is required to be given, under the DGCL, the certificate of incorporation or these bylaws, to any person with whom communication is unlawful, the giving of such notice to such person shall not be required and there shall be no duty to apply to any governmental authority or agency for a license or permit to give such notice to such person. Any action or meeting which shall be taken or held without notice to any such person with whom communication is unlawful shall have the same force and effect as if such notice had been duly given. If the action taken by the corporation is such as to require the filing of a certificate under the DGCL, the certificate shall state, if such is the fact and if notice is required, that notice was given to all persons entitled to receive notice except such persons with whom communication is unlawful.

### 7.5 WAIVER OF NOTICE

Whenever notice is required to be given under any provision of the DGCL, the certificate of incorporation or these bylaws, a written waiver, signed by the person entitled to notice, or a waiver by electronic transmission by the person entitled to notice, whether before or after the time of the event for which notice is to be given, shall be deemed equivalent to notice. Attendance of a person at a meeting shall constitute a waiver of notice of such meeting, except when the person attends a meeting for the express purpose of objecting at the beginning of the meeting, to the transaction of any business because the meeting is not lawfully called or convened. Neither the business to be transacted at, nor the purpose of, any regular or special meeting of the stockholders need be specified in any written waiver of notice or any waiver by electronic transmission unless so required by the certificate of incorporation or these bylaws.

**ARTICLE VIII  
INDEMNIFICATION**

**8.1 INDEMNIFICATION OF DIRECTORS AND OFFICERS IN THIRD PARTY PROCEEDINGS**

Subject to the other provisions of this Article VIII, the corporation shall indemnify, to the fullest extent permitted by the DGCL, as now or hereinafter in effect, any person who was or is a party or is threatened to be made a party to any threatened, pending or completed action, suit or proceeding, whether civil, criminal, administrative or investigative (a "**Proceeding**") (other than an action by or in the right of the corporation) by reason of the fact that such person is or was a director or officer of the corporation, or is or was a director or officer of the corporation serving at the request of the corporation as a director, officer, employee or agent of another corporation, partnership, joint venture, trust or other enterprise, against expenses (including attorneys' fees), judgments, fines and amounts paid in settlement actually and reasonably incurred by such person in connection with such Proceeding if such person acted in good faith and in a manner such person reasonably believed to be in or not opposed to the best interests of the corporation and, with respect to any criminal action or proceeding, had no reasonable cause to believe such person's conduct was unlawful. The termination of any Proceeding by judgment, order, settlement, conviction or upon a plea of *nolo contendere* or its equivalent, shall not, of itself, create a presumption that the person did not act in good faith and in a manner which such person reasonably believed to be in or not opposed to the best interests of the corporation and, with respect to any criminal action or proceeding, had reasonable cause to believe that such person's conduct was unlawful.

**8.2 INDEMNIFICATION OF DIRECTORS AND OFFICERS IN ACTIONS BY OR IN THE RIGHT OF THE CORPORATION**

Subject to the other provisions of this Article VIII, the corporation shall indemnify, to the fullest extent permitted by the DGCL, as now or hereinafter in effect, any person who was or is a party or is threatened to be made a party to any threatened, pending or completed action or suit by or in the right of the corporation to procure a judgment in its favor by reason of the fact that such person is or was a director or officer of the corporation, or is or was a director or officer of the corporation serving at the request of the corporation as a director, officer, employee or agent of another corporation, partnership, joint venture, trust or other enterprise against expenses (including attorneys' fees) actually and reasonably incurred by such person in connection with the defense or settlement of such action or suit if such person acted in good faith and in a manner such person reasonably believed to be in or not opposed to the best interests of the corporation; except that no indemnification shall be made in respect of any claim, issue or matter as to which such person shall have been adjudged to be liable to the corporation unless and only to the extent that the Court of Chancery or the court in which such action or suit was brought shall determine upon application that, despite the adjudication of liability but in view of all the circumstances of the case, such person is fairly and reasonably entitled to indemnity for such expenses which the Court of Chancery or such other court shall deem proper.

### 8.3 SUCCESSFUL DEFENSE

To the extent that a present or former director or officer of the corporation has been successful on the merits or otherwise in defense of any action, suit or proceeding described in Section 8.1 or Section 8.2, or in defense of any claim, issue or matter therein, such person shall be indemnified against expenses (including attorneys' fees) actually and reasonably incurred by such person in connection therewith.

### 8.4 INDEMNIFICATION OF OTHERS

Subject to the other provisions of this Article VIII, the corporation shall have the power to indemnify its employees and agents to the extent not prohibited by the DGCL or other applicable law. The board of directors shall have the power to delegate to such person or persons as the board shall in its discretion determine the determination of whether employees or agents shall be indemnified.

### 8.5 ADVANCE PAYMENT OF EXPENSES

Expenses (including attorneys' fees) actually and reasonably incurred by an officer or director of the corporation in defending any Proceeding shall be paid by the corporation in advance of the final disposition of such Proceeding upon receipt of a written request therefor (together with documentation reasonably evidencing such expenses) and an undertaking by or on behalf of the person to repay such amounts if it shall ultimately be determined that the person is not entitled to be indemnified under this Article VIII or the DGCL. Such expenses (including attorneys' fees) incurred by former directors and officers or other employees and agents of the corporation or by persons serving at the request of the corporation as directors, officers, employees or agents of another corporation, partnership, joint venture, trust or other enterprise may be so paid upon such terms and conditions, if any, as the corporation deems appropriate. The right to advancement of expenses shall not apply to any claim for which indemnity is excluded pursuant to these bylaws, but shall apply to any Proceeding referenced in Section 8.6(ii) or 8.6(iii) prior to a determination that the person is not entitled to be indemnified by the corporation.

### 8.6 LIMITATION ON INDEMNIFICATION

Subject to the requirements in Section 8.3 and the DGCL, the corporation shall not be obligated to indemnify any person pursuant to this Article VIII in connection with any Proceeding (or any part of any Proceeding):

- (i) for which payment has actually been made to or on behalf of such person under any statute, insurance policy, indemnity provision, vote or otherwise, except with respect to any excess beyond the amount paid;
- (ii) for an accounting or disgorgement of profits pursuant to Section 16(b) of the Exchange Act, or similar provisions of federal, state or local statutory law or common law, if such person is held liable therefor (including pursuant to any settlement arrangements);

(iii) for any reimbursement of the corporation by such person of any bonus or other incentive-based or equity-based compensation or of any profits realized by such person from the sale of securities of the corporation, as required in each case under the Exchange Act (including any such reimbursements that arise from an accounting restatement of the corporation pursuant to Section 304 of the Sarbanes-Oxley Act of 2002, as amended (the “**Sarbanes-Oxley Act**”), or the payment to the corporation of profits arising from the purchase and sale by such person of securities in violation of Section 306 of the Sarbanes-Oxley Act), if such person is held liable therefor (including pursuant to any settlement arrangements);

(iv) initiated by such person, including any Proceeding (or any part of any Proceeding) initiated by such person against the corporation or its directors, officers, employees, agents or other indemnitees, unless (a) the board of directors authorized the Proceeding (or the relevant part of the Proceeding) prior to its initiation, (b) the corporation provides the indemnification, in its sole discretion, pursuant to the powers vested in the corporation under applicable law, (c) otherwise required to be made under Section 8.7 or (d) otherwise required by applicable law; or

(v) if prohibited by applicable law; provided, however, that if any provision or provisions of this Article VIII shall be held to be invalid, illegal or unenforceable for any reason whatsoever: (1) the validity, legality and enforceability of the remaining provisions of this Article VIII (including, without limitation, each portion of any paragraph or clause containing any such provision held to be invalid, illegal or unenforceable, that is not itself held to be invalid, illegal or unenforceable) shall not in any way be affected or impaired thereby; and (2) to the fullest extent possible, the provisions of this Article VIII (including, without limitation, each such portion of any paragraph or clause containing any such provision held to be invalid, illegal or unenforceable) shall be construed so as to give effect to the intent manifested by the provision held invalid, illegal or unenforceable.

#### 8.7 DETERMINATION; CLAIM

If a claim for indemnification or advancement of expenses under this Article VIII is not paid in full within 90 days after receipt by the corporation of the written request therefor, the claimant shall be entitled to an adjudication by a court of competent jurisdiction of his or her entitlement to such indemnification or advancement of expenses. The corporation shall indemnify such person against any and all expenses that are actually and reasonably incurred by such person in connection with any action for indemnification or advancement of expenses from the corporation under this Article VIII, to the extent such person is successful in such action, and to the extent not prohibited by law. In any such suit, the corporation shall, to the fullest extent not prohibited by law, have the burden of proving that the claimant is not entitled to the requested indemnification or advancement of expenses.

#### 8.8 NON-EXCLUSIVITY OF RIGHTS

The indemnification and advancement of expenses provided by, or granted pursuant to, this Article VIII shall not be deemed exclusive of any other rights to which those seeking indemnification or advancement of expenses may be entitled under the certificate of incorporation or any statute, bylaw, agreement, vote of stockholders or disinterested directors or otherwise, both



as to action in such person's official capacity and as to action in another capacity while holding such office. The corporation is specifically authorized to enter into individual contracts with any or all of its directors, officers, employees or agents respecting indemnification and advancement of expenses, to the fullest extent not prohibited by the DGCL or other applicable law.

#### 8.9 INSURANCE

The corporation may purchase and maintain insurance on behalf of any person who is or was a director, officer, employee or agent of the corporation, or is or was serving at the request of the corporation as a director, officer, employee or agent of another corporation, partnership, joint venture, trust or other enterprise against any liability asserted against such person and incurred by such person in any such capacity, or arising out of such person's status as such, whether or not the corporation would have the power to indemnify such person against such liability under the provisions of the DGCL.

#### 8.10 SURVIVAL

The rights to indemnification and advancement of expenses conferred by this Article VIII shall continue as to a person who has ceased to be a director, officer, employee or agent and shall inure to the benefit of the heirs, executors and administrators of such a person.

#### 8.11 EFFECT OF REPEAL OR MODIFICATION

A right to indemnification or to advancement of expenses arising under a provision of the certificate of incorporation or a bylaw shall not be eliminated or impaired by an amendment to the certificate of incorporation or these bylaws after the occurrence of the act or omission that is the subject of the civil, criminal, administrative or investigative action, suit or proceeding for which indemnification or advancement of expenses is sought, unless the provision in effect at the time of such act or omission explicitly authorizes such elimination or impairment after such action or omission has occurred.

#### 8.12 CERTAIN DEFINITIONS

For purposes of this Article VIII, references to the "**corporation**" shall include, in addition to the resulting corporation, any constituent corporation (including any constituent of a constituent) absorbed in a consolidation or merger which, if its separate existence had continued, would have had power and authority to indemnify its directors, officers, employees or agents, so that any person who is or was a director, officer, employee or agent of such constituent corporation, or is or was serving at the request of such constituent corporation as a director, officer, employee or agent of another corporation, partnership, joint venture, trust or other enterprise, shall stand in the same position under the provisions of this Article VIII with respect to the resulting or surviving corporation as such person would have with respect to such constituent corporation if its separate existence had continued. For purposes of this Article VIII, references to "**other enterprises**" shall include employee benefit plans; references to "**finances**" shall include any excise taxes assessed on a person with respect to an employee benefit plan; and references to "**servicing at the request of the corporation**" shall include any service as a director, officer, employee or agent of the corporation which imposes duties on, or involves services by, such director, officer, employee or agent with respect to an employee benefit plan, its participants or beneficiaries; and a

person who acted in good faith and in a manner such person reasonably believed to be in the interest of the participants and beneficiaries of an employee benefit plan shall be deemed to have acted in a manner “**not opposed to the best interests of the corporation**” as referred to in this Article VIII.

## ARTICLE IX GENERAL MATTERS

### 9.1 EXECUTION OF CORPORATE CONTRACTS AND INSTRUMENTS

Except as otherwise provided by law, the certificate of incorporation or these bylaws, the board of directors may authorize any officer or officers, or agent or agents, to enter into any contract or execute any document or instrument in the name of and on behalf of the corporation; such authority may be general or confined to specific instances. Unless so authorized or ratified by the board of directors or within the agency power of an officer, no officer, agent or employee shall have any power or authority to bind the corporation by any contract or engagement or to pledge its credit or to render it liable for any purpose or for any amount.

### 9.2 FISCAL YEAR

The fiscal year of the corporation shall be fixed by resolution of the board of directors and may be changed by the board of directors.

### 9.3 SEAL

The corporation may adopt a corporate seal, which shall be adopted and which may be altered by the board of directors. The corporation may use the corporate seal by causing it or a facsimile thereof to be impressed or affixed or in any other manner reproduced.

### 9.4 CONSTRUCTION; DEFINITIONS

Unless the context requires otherwise, the general provisions, rules of construction, and definitions in the DGCL shall govern the construction of these bylaws. Without limiting the generality of this provision, the singular number includes the plural, the plural number includes the singular, and the term “**person**” includes both a corporation and a natural person.

### 9.5 FORUM

Unless the corporation consents in writing to the selection of an alternative forum, the sole and exclusive forum for (i) any derivative action or proceeding brought on behalf of the corporation, (ii) any action asserting a claim of breach of a fiduciary duty owed by any director, officer or other employee of the corporation to the corporation or the corporation’s stockholders, (iii) any action asserting a claim arising pursuant to any provision of the DGCL, the corporation’s certificate of incorporation, or these bylaws, (iv) any action to interpret, apply, enforce, or determine the validity of the corporation’s certificate of incorporation or these bylaws, or (v) any action asserting a claim governed by the internal affairs doctrine shall be a state or federal court located within the state of Delaware, in all cases subject to the court’s having personal jurisdiction over the indispensable parties named as defendants. Any person or entity purchasing or otherwise acquiring any interest in shares of capital stock of the corporation shall be deemed to have notice of and consented to the provisions of this Section 9.5.

---

**ARTICLE X**  
**AMENDMENTS**

These bylaws may be adopted, amended or repealed by the stockholders entitled to vote; provided, however, that the affirmative vote of the holders of at least sixty-six and two-thirds percent (66-2/3%) of the total voting power of outstanding voting securities, voting together as a single class, shall be required for the stockholders of the corporation to alter, amend or repeal, or adopt any provision of these bylaws. The board of directors shall also have the power to adopt, amend or repeal bylaws.

A bylaw amendment adopted by stockholders which specifies the votes that shall be necessary for the election of directors shall not be further amended or repealed by the board of directors.

## ALTAIR ENGINEERING INC.

## 2017 EQUITY INCENTIVE PLAN

1. Purposes of the Plan. The purposes of this Plan are:

- to attract and retain the best available personnel for positions of substantial responsibility,
- to provide additional incentive to Employees, Directors and Consultants, and
- to promote the success of the Company's business.

The Plan permits the grant of Incentive Stock Options, Nonstatutory Stock Options, Restricted Stock, Restricted Stock Units, Stock Appreciation Rights, Performance Units, Performance Shares, Other Cash-Based Awards and Other Stock-Based Awards.

2. Definitions. As used herein, the following definitions will apply:

(a) "Administrator" means the Board or any of its Committees as will be administering the Plan, in accordance with Section 4 of the Plan.

(b) "Affiliate" means, with respect to a Person, a Person that directly or indirectly Controls, or is Controlled by, or is under common Control with, such Person.

(c) "Applicable Laws" means the requirements relating to the administration of equity-based awards under U.S. state corporate laws, U.S. federal and state securities laws, the Code, any stock exchange or quotation system on which the Common Stock is listed or quoted and the applicable laws of any foreign country or jurisdiction where Awards are, or will be, granted under the Plan.

(d) "Award" means, individually or collectively, a grant under the Plan of Options, Stock Appreciation Rights, Restricted Stock, Restricted Stock Units, Performance Units, Performance Shares, an Other Cash-Based Award, or an Other Stock-Based Award.

(e) "Award Agreement" means the written or electronic agreement setting forth the terms and provisions applicable to each Award granted under the Plan. The Award Agreement is subject to the terms and conditions of the Plan.

(f) "Board" means the Board of Directors of the Company.

(g) "Cause" means (i) conviction of, or the entry of a plea of guilty or no contest to, a felony or any other crime that causes the Company or its Affiliates public disgrace or disrepute, or materially and adversely affects the Company's or its Affiliates' operations or financial performance or the relationship the Company has with its customers, (ii) gross negligence or willful misconduct with respect to the Company or any of its Affiliates, including, without limitation fraud, embezzlement, theft or proven dishonesty in the course of his or her employment; (iii) refusal to perform any lawful, material obligation or fulfill any duty (other

than any duty or obligation of the type described in clause (v) below) to the Company or its Affiliates (other than due to a Disability), which refusal, if curable, is not cured within 10 days after delivery of written notice thereof; (iv) material breach of any agreement with or duty owed to the Company or any of its Affiliates, which breach, if curable, is not cured within 10 days after the delivery of written notice thereof; or (v) any breach of any obligation or duty to the Company or any of its Affiliates (whether arising by statute, common law or agreement) relating to confidentiality, noncompetition, nonsolicitation or proprietary rights. Notwithstanding the foregoing, if a Participant and the Company (or any of its Affiliates) have entered into an employment agreement, consulting agreement or other similar agreement that specifically defines "cause," then with respect to such Participant, "Cause" shall have the meaning defined in that employment agreement, consulting agreement or other agreement.

(h) "Change in Control" means the occurrence of any of the following events:

(i) A change in the ownership of the Company which occurs on the date that any one Person, or more than one Person acting as a group, acquires ownership of the stock of the Company that, together with the stock held by such Person, constitutes more than fifty percent (50%) of the total voting power of the stock of the Company; provided, however, that for purposes of this subsection, the acquisition of additional stock by any one Person, who is considered to own more than fifty percent (50%) of the total voting power of the stock of the Company will not be considered a Change in Control. Further, if the stockholders of the Company immediately before such change in ownership continue to retain immediately after the change in ownership, in substantially the same proportions as their ownership of shares of the Company's voting stock immediately prior to the change in ownership, direct or indirect beneficial ownership of fifty percent (50%) or more of the total voting power of the stock of the Company or of the ultimate parent entity of the Company, such event shall not be considered a Change in Control under this subsection (i). For this purpose, indirect beneficial ownership shall include, without limitation, an interest resulting from ownership of the voting securities of one or more corporations or other business entities which own the Company, as the case may be, either directly or through one or more subsidiary corporations or other business entities;

(ii) A change in the effective control of the Company which occurs on the date that a majority of members of the Board is replaced during any twelve (12) month period by Directors whose appointment or election is not endorsed by a majority of the members of the Board prior to the date of the appointment or election. For purposes of this subsection (ii), if any Person is considered to be in effective control of the Company, the acquisition of additional control of the Company by the same Person will not be considered a Change in Control; or

(iii) A change in the ownership of a substantial portion of the Company's assets which occurs on the date that any Person acquires (or has acquired during the twelve (12) month period ending on the date of the most recent acquisition by such Person or Persons) assets from the Company that have a total gross fair market value equal to or more than fifty percent (50%) of the total gross fair market value of all of the assets of the Company immediately prior to such acquisition or acquisitions;

provided, however, that for purposes of this subsection (iii), the following will not constitute a change in the ownership of a substantial portion of the Company's assets: (A) a transfer to an entity that is controlled by the Company's stockholders immediately after the transfer, or (B) a transfer of assets by the Company to: (1) a stockholder of the Company (immediately before the asset transfer) in exchange for or with respect to the Company's stock, (2) an entity, fifty percent (50%) or more of the total value or voting power of which is owned, directly or indirectly, by the Company, (3) a Person, that owns, directly or indirectly, fifty percent (50%) or more of the total value or voting power of all the outstanding stock of the Company, or (4) an entity, at least fifty percent (50%) of the total value or voting power of which is owned, directly or indirectly, by a Person described in this subsection (iii)(B) (3). For purposes of this subsection (iii), gross fair market value means the value of the assets of the Company, or the value of the assets being disposed of, determined without regard to any liabilities associated with such assets.

Notwithstanding the foregoing, a transaction will not be deemed a Change in Control unless the transaction qualifies as a "change in control event" within the meaning of Section 409A of the Code, as it has been and may be amended from time to time, and any proposed or final Treasury Regulations and Internal Revenue Service guidance that has been promulgated or may be promulgated thereunder from time to time.

Further and for the avoidance of doubt, a transaction will not constitute a Change in Control if: (i) its sole purpose is to change the state of the Company's incorporation, or (ii) its sole purpose is to create a holding company that will be owned in substantially the same proportions by the Persons who held the Company's securities immediately before such transaction.

(i) "Code" means the Internal Revenue Code of 1986, as amended. Reference to a specific section of the Code or regulation thereunder shall include such section or regulation, any valid regulation promulgated under such section, and any comparable provision of any future legislation or regulation amending, supplementing or superseding such section or regulation.

(j) "Committee" means a committee of Directors or of other individuals satisfying Applicable Laws appointed by the Board, or a duly authorized committee of the Board, in accordance with Section 4 of the Plan.

(k) "Common Stock" means, as of the Registration Date, the Class A common stock of the Company.

(l) "Company" means, as of the Registration Date, Altair Engineering Inc., a Delaware corporation, or any successor thereto.

(m) "Consultant" means any Person, including an advisor, engaged by the Company or a Parent, Subsidiary or Affiliate to render bona fide services to such entity, provided the services (i) are not in connection with the offer or sale of securities in a capital-raising transaction, and (ii) do not directly promote or maintain a market for the Company's securities, in each case, within the meaning of Form S-8 promulgated under the Securities Act, and provided, further, that a Consultant will include only those Persons to whom the issuance of Shares may be registered under Form S-8 promulgated under the Securities Act.

(n) “Control” means, as to any Person, the power to direct or cause the direction of the management and policies of such Person (the terms “Controlled by” and “under common Control with” shall have correlative meanings).

(o) “Director” means a member of the Board.

(p) “Disability” means total and permanent disability as defined in Section 22(e)(3) of the Code, provided that in the case of Awards other than Incentive Stock Options, the Administrator in its sole discretion may determine whether a permanent and total disability exists in accordance with uniform and non-discriminatory standards adopted by the Administrator from time to time.

(q) “Employee” means any natural Person, including Officers and Directors, providing services as an employee of the Company or any Parent, Subsidiary or Affiliate of the Company. Neither service as a Director nor payment of a director’s fee by the Company will be sufficient to constitute “employment” by the Company.

(r) “Exchange Act” means the Securities Exchange Act of 1934, as amended.

(s) “Exchange Program” means a program under which (i) outstanding Awards are surrendered or cancelled in exchange for awards of the same type (which may have higher or lower exercise prices and different terms), awards of a different type, and/or cash, (ii) Participants would have the opportunity to transfer any outstanding Awards to a financial institution or other Person selected by the Administrator, and/or (iii) the exercise price of an outstanding Award is increased or reduced. The Administrator will determine the terms and conditions of any Exchange Program in its sole discretion.

(t) “Fair Market Value” means, as of any date, the value of Common Stock determined as follows:

(i) If the Common Stock is listed on any established stock exchange or a national market system, including without limitation the New York Stock Exchange, the NASDAQ Global Select Market, the NASDAQ Global Market or the NASDAQ Capital Market of The NASDAQ Stock Market, its Fair Market Value will be the closing sales price for such stock (or the closing bid, if no sales were reported) as quoted on such exchange or system on the day of determination, as reported in *The Wall Street Journal* or such other source as the Administrator deems reliable;

(ii) If the Common Stock is regularly quoted by a recognized securities dealer but selling prices are not reported, the Fair Market Value of a Share will be the mean between the high bid and low asked prices for the Common Stock on the day of determination (or, if no bids and asks were reported on that date, as applicable, on the last trading date such bids and asks were reported), as reported in *The Wall Street Journal* or such other source as the Administrator deems reliable;

(iii) For purposes of any Awards granted on the Registration Date, the Fair Market Value will be the initial price to the public as set forth in the final prospectus included within the registration statement on Form S-1 filed with the Securities and Exchange Commission for the initial public offering of the Common Stock; or

(iv) In the absence of an established market for the Common Stock, the Fair Market Value will be determined in good faith by the Administrator in a manner consistent with Section 409A of the Code and Treasury Regulation 1.409A-1(b)(5)(iv).

(u) "Fiscal Year" means the fiscal year of the Company.

(v) "Incentive Stock Option" means an Option intended to qualify as an incentive stock option within the meaning of Section 422 of the Code and the regulations promulgated thereunder.

(w) "Inside Director" means a Director who is an Employee.

(x) "Nonstatutory Stock Option" means an Option that by its terms does not qualify or is not intended to qualify as an Incentive Stock Option.

(y) "Officer" means a natural Person who is an officer of the Company within the meaning of Section 16 of the Exchange Act and the rules and regulations promulgated thereunder.

(z) "Option" means a stock option granted pursuant to the Plan.

(aa) "Other Cash-Based Award" means a contractual right granted to a Service Provider under Section 12 of the Plan entitling such Service Provider to receive a cash payment at such times, and subject to such conditions, as are set forth in the Plan and the applicable Award Agreement.

(bb) "Other Stock-Based Award" means a contractual right granted to a Service Provider under Section 12 of the Plan representing a notional unit interest equal in value to a share of Common Stock to be paid and distributed at such times, and subject to such conditions, as are set forth in the Plan and the applicable Award Agreement.

(cc) "Outside Director" means a Director who is not an Employee.

(dd) "Parent" means a "parent corporation," whether now or hereafter existing, as defined in Section 424(e) of the Code in relation to the Company.

(ee) "Participant" means the holder of an outstanding Award.

(ff) "Performance Goals" shall mean performance goals established by the Administrator as contingencies for the grant, exercise, vesting, distribution, payment and/or settlement, as applicable, of Awards.

(gg) "Performance Share" means an Award denominated in Shares which may be earned in whole or in part upon attainment of performance goals or other vesting criteria as the Administrator may determine pursuant to Section 10 of the Plan.



(hh) "Performance Unit" means an Award which may be earned in whole or in part upon attainment of performance goals or other vesting criteria as the Administrator may determine and which may be settled for cash, Shares or other securities or a combination of the foregoing pursuant to Section 10 of the Plan.

(ii) "Period of Restriction" means the period during which the transfer of Shares of Restricted Stock are subject to restrictions and therefore, the Shares are subject to a substantial risk of forfeiture. Such restrictions may be based on the passage of time, the achievement of target levels of performance, or the occurrence of other events as determined by the Administrator.

(jj) "Person" shall mean any individual, partnership, firm, trust, corporation, limited liability company or other similar entity. When two or more Persons act as a partnership, limited partnership, syndicate or other group for the purpose of acquiring, holding or disposing of Shares, such partnership, limited partnership, syndicate or group shall be deemed a "Person".

(kk) "Plan" means this Altair Engineering Inc. 2017 Equity Incentive Plan.

(ll) "Registration Date" means the effective date of the first registration statement that is filed by the Company and declared effective pursuant to Section 12 of the Exchange Act, with respect to any class of the Company's securities.

(mm) "Reporting Person" means an officer, director or greater than ten percent stockholder of the Company within the meaning of Rule 16a-2 under the Exchange Act, who is required to file reports pursuant to Rule 16a-3 under the Exchange Act.

(nn) "Restricted Stock" means Shares issued pursuant to a Restricted Stock award under Section 7 of the Plan, or issued pursuant to the early exercise of an Option.

(oo) "Restricted Stock Unit" means a bookkeeping entry representing an amount equal to the Fair Market Value of one Share, granted pursuant to Section 8 of the Plan. Each Restricted Stock Unit represents an unfunded and unsecured obligation of the Company.

(pp) "Rule 16b-3" means Rule 16b-3 of the Exchange Act or any successor to Rule 16b-3, as in effect when discretion is being exercised with respect to the Plan.

(qq) "Section 16(b)" means Section 16(b) of the Exchange Act.

(rr) "Section 162(m) Award" shall mean any Award granted pursuant to the Plan that is intended to qualify for the exception for "qualified performance-based compensation" under Section 162(m) of the Code and the regulations thereunder.

(ss) "Securities Act" means the Securities Act of 1933, as amended.

(tt) "Service Provider" means an Employee, Director or Consultant.

(uu) “Share” means a share of Common Stock, as adjusted in accordance with Section 16 of the Plan.

(vv) “Stock Appreciation Right” means an Award, granted alone or in connection with an Option, that pursuant to Section 9 of the Plan is designated as a Stock Appreciation Right.

(ww) “Subsidiary” means a “subsidiary corporation,” whether now or hereafter existing, as defined in Section 424(f) of the Code in relation to the Company.

### 3. Stock Subject to the Plan.

(a) Stock Subject to the Plan. Subject to the provisions of Section 16 of the Plan and the automatic increase set forth in Section 3(b), the maximum aggregate number of Shares that may be issued under the Plan is 6,207,976 Shares. In addition, Shares may become available for issuance under the Plan pursuant to Sections 3(b) and 3(c). The Shares may be authorized, but unissued, or reacquired Common Stock.

(b) Automatic Share Reserve Increase. Subject to the provisions of Section 16 of the Plan, the number of Shares available for issuance under the Plan will automatically be increased on the first day of each Fiscal Year beginning with the 2018 Fiscal Year, in an amount equal to the least of (i) three percent (3%) of the outstanding shares of all classes of the Company’s common stock on the last day of the immediately preceding Fiscal Year, or (ii) such number of Shares determined by the Administrator (the “Annual Increase”).

(c) Lapsed Awards. If an Award expires or becomes unexercisable without having been exercised in full, is surrendered pursuant to an Exchange Program, or, with respect to any Award payable in Shares, is forfeited to or repurchased by the Company due to failure to vest, the unpurchased Shares (or for Awards other than Options or Stock Appreciation Rights the forfeited or repurchased Shares), which were subject thereto will become available for future grant or sale under the Plan (unless the Plan has terminated). With respect to Stock Appreciation Rights, only Shares actually issued (i.e., the net Shares issued) pursuant to a Stock Appreciation Right will cease to be available under the Plan; all remaining Shares under Stock Appreciation Rights will remain available for future grant or sale under the Plan (unless the Plan has terminated). Shares that have actually been issued under the Plan under any Award will not be returned to the Plan and will not become available for future distribution under the Plan; provided, however, that if Shares issued pursuant to an Award payable in Shares are repurchased by the Company or are forfeited to the Company, such Shares will become available for future grant under the Plan. Shares used to pay the exercise price of an Award or to satisfy the tax withholding obligations related to an Award will become available for future grant or sale under the Plan. To the extent an Award under the Plan is paid out in cash rather than Shares, such cash payment will not result in reducing the number of Shares available for issuance under the Plan. Notwithstanding the foregoing and, subject to adjustment as provided in Section 16 of the Plan, the maximum number of Shares that may be issued upon the exercise of Incentive Stock Options will equal the aggregate Share number stated in Section 3(a), and shall be increased on January 1, 2018 and each January 1 thereafter until (and including) January 1, 2027, by the lesser of (i) the Annual Increase for such calendar year, and (ii) 1,980,292 Shares.

(d) Share Reserve. The Company, during the term of this Plan, will at all times reserve and keep available such number of Shares as will be sufficient to satisfy the requirements of the Plan.

#### 4. Administration of the Plan.

##### (a) Procedure.

(i) Multiple Administrative Bodies. Different Committees with respect to different groups of Service Providers may administer the Plan.

(ii) Section 162(m). To the extent that the Administrator determines it to be desirable to qualify Awards granted hereunder as Section 162(m) Awards, the Plan will be administered by a Committee of two (2) or more "outside directors" within the meaning of Section 162(m) of the Code.

(iii) Rule 16b-3. To the extent desirable to qualify transactions hereunder as exempt under Rule 16b-3, the transactions contemplated hereunder will be structured to satisfy the requirements for exemption under Rule 16b-3.

(iv) Other Administration. Other than as provided above, the Plan will be administered by (A) the Board or (B) a Committee, which committee will be constituted to satisfy Applicable Laws.

(b) Powers of the Administrator. Subject to the provisions of the Plan, and in the case of a Committee, subject to the specific duties delegated by the Board to such Committee, the Administrator will have the authority, in its sole discretion:

(i) to determine the Fair Market Value;

(ii) to select the Service Providers to whom Awards may be granted hereunder;

(iii) to determine the number of Shares to be covered by each Award granted hereunder;

(iv) to approve forms of Award Agreements for use under the Plan;

(v) to determine the terms and conditions, not inconsistent with the terms of the Plan, of any Award granted hereunder. Such terms and conditions include, but are not limited to, the exercise price, the time or times when Awards may be exercised (which may be based on performance criteria), any vesting acceleration or waiver of forfeiture restrictions, and any restriction or limitation regarding any Award or the Shares relating thereto, based in each case on such factors as the Administrator will determine;

(vi) to institute and determine the terms and conditions of an Exchange Program;

(vii) to construe and interpret the terms of the Plan and Awards granted pursuant to the Plan;

(viii) to prescribe, amend and rescind rules and regulations relating to the Plan, including rules and regulations relating to sub-plans established for the purpose of satisfying applicable foreign laws or for qualifying for favorable tax treatment under applicable foreign laws;

(ix) to modify or amend each Award (subject to Section 20 of the Plan), including but not limited to the discretionary authority to extend the post-termination exercisability period of Awards, and to accelerate the vesting or exercisability of any Award;

(x) to allow Participants to satisfy tax withholding obligations in such manner as prescribed in Section 17 of the Plan;

(xi) to authorize any Person to execute on behalf of the Company any instrument required to effect the grant of an Award previously granted by the Administrator;

(xii) to allow a Participant to defer the receipt of the payment of cash or the delivery of Shares that would otherwise be due to such Participant under an Award; and

(xiii) to make all other determinations deemed necessary or advisable for administering the Plan.

(c) Effect of Administrator's Decision. The Administrator's decisions, determinations, interpretations and actions will be final, conclusive and binding on all Participants and any other holders of Awards. The Administrator's decisions, determinations, interpretations and actions under the Plan need not be uniform.

(d) No Liability; Indemnification. The Administrator shall not be liable for any act, omission, interpretation, construction or determination made in good faith with respect to the Plan, any Award or any Award Agreement. The Company and its Subsidiaries shall pay or reimburse the Administrator, as well as any other Person who has the authority to and takes action on behalf of the Plan, for all reasonable expenses incurred with respect to the Plan, and to the full extent allowable under Applicable Laws shall indemnify each and every one of them for any claims, liabilities, and costs (including, without limitation, reasonable attorney's fees) arising out of their good faith performance of duties on behalf of the Company with respect to the Plan. The Company and its Subsidiaries may, but shall not be required to, obtain liability insurance for this purpose.

5. Eligibility. Nonstatutory Stock Options, Stock Appreciation Rights, Restricted Stock, Restricted Stock Units, Performance Shares, Performance Units, Other Cash-Based Awards, and Other Stock-Based Awards may be granted to Service Providers. Incentive Stock Options may be granted only to Employees of the Company or a Parent or Subsidiary.

## 6. Stock Options.

(a) Limitations. Each Option will be designated in the Award Agreement as either an Incentive Stock Option or a Nonstatutory Stock Option. However, notwithstanding such designation, to the extent that the aggregate Fair Market Value of the Shares with respect to which Incentive Stock Options are exercisable for the first time by the Participant during any calendar year (under all plans of the Company and any Parent or Subsidiary) exceeds one hundred thousand dollars (\$100,000), such Options will be treated as Nonstatutory Stock Options. For purposes of this Section 6(a), Incentive Stock Options will be taken into account in the order in which they were granted. The Fair Market Value of the Shares will be determined as of the time the Option with respect to such Shares is granted.

(b) Term of Option. The term of each Option will be stated in the Award Agreement. In the case of an Incentive Stock Option, the term will be no more than ten (10) years from the date of grant (or five (5) years in the case of an Incentive Stock Option granted to a Participant who, at the time the Incentive Stock Option is granted, owns stock representing more than ten percent (10%) of the total combined voting power of all classes of stock of the Company or any Parent or Subsidiary).

### (c) Option Exercise Price and Consideration.

(i) Exercise Price. The per share exercise price for the Shares to be issued pursuant to exercise of an Option will be determined by the Administrator, but shall not be less than one hundred percent (100%) of the Fair Market Value per Share on the date of grant (or 110% for an Incentive Stock Option granted to an Employee who, at the time the Incentive Stock Option is granted, owns stock representing more than ten percent (10%) of the voting power of all classes of stock of the Company or any Parent or Subsidiary). Notwithstanding the foregoing, Options may be granted with a per Share exercise price of less than one hundred percent (100%) of the Fair Market Value per Share on the date of grant pursuant to a transaction described in, and in a manner consistent with, Section 424(a) of the Code.

(ii) Waiting Period and Exercise Dates. At the time an Option is granted, the Administrator will fix the period within which the Option may be exercised and will determine any conditions that must be satisfied before the Option may be exercised.

(iii) Form of Consideration. The Administrator will determine the acceptable form of consideration for exercising an Option, including the method of payment. In the case of an Incentive Stock Option, the Administrator will determine the acceptable form of consideration at the time of grant. Such consideration may consist entirely of one or more of the following: (A) cash; (B) check; (C) promissory note, to the extent permitted by Applicable Laws; (D) other Shares, provided that such Shares have a Fair Market Value on the date of surrender equal to the aggregate exercise price of the Shares as to which such Option will be exercised and provided that accepting such Shares will not result in any adverse accounting consequences to the Company, as the Administrator determines in its sole discretion; (E) consideration received by the

Company under a cashless exercise program (whether through a broker or otherwise) implemented by the Company in connection with the Plan; (F) via net exercise; or (G) such other consideration and method of payment for the issuance of Shares to the extent permitted by Applicable Laws.

(d) Exercise of Option.

(i) Procedure for Exercise; Rights as a Stockholder. Any Option granted hereunder will be exercisable according to the terms of the Plan and at such times and under such conditions as determined by the Administrator and set forth in the Award Agreement. An Option may not be exercised for a fraction of a Share.

An Option will be deemed exercised when the Company receives: (i) a notice of exercise (in such form as the Administrator may specify from time to time) from the Person entitled to exercise the Option, and (ii) full payment for the Shares with respect to which the Option is exercised (together with applicable withholding taxes). Full payment may consist of any consideration and method of payment authorized by the Administrator and permitted by the Award Agreement and the Plan. Shares issued upon exercise of an Option will be issued in the name of the Participant or, if requested by the Participant, in the name of the Participant and his or her spouse.

(ii) Disqualifying Dispositions. If Shares acquired by exercise of an Incentive Stock Option are disposed of within two (2) years following the date of grant of such Option or one (1) year following the transfer of such Shares to the Participant upon exercise of such Option, the Participant shall, promptly following such disposition of Shares, notify the Company in writing of the date and terms of such disposition and provide such other information regarding the disposition as the Company may reasonably require.

(iii) Termination of Relationship as a Service Provider. If a Participant ceases to be a Service Provider, other than upon the Participant's termination as the result of the Participant's death or Disability, the Participant may exercise his or her Option within such period of time as is specified in the Award Agreement to the extent that the Option is vested on the date of termination (but in no event later than the expiration of the term of such Option as set forth in the Award Agreement). In the absence of a specified time in the Award Agreement, the Option will remain exercisable for ninety (90) days following the Participant's termination. Unless otherwise provided by the Administrator, if on the date of termination the Participant is not vested as to his or her entire Option, the Shares covered by the unvested portion of the Option will revert to the Plan. If after termination the Participant does not exercise any vested portion of his or her Option within the time specified by the Administrator, such vested portion of the Option will terminate, and the Shares covered by such vested portion of the Option will revert to the Plan.

(iv) Disability of Participant. If a Participant ceases to be a Service Provider as a result of the Participant's Disability, the Participant may exercise his or her Option within such period of time as is specified in the Award Agreement to the extent

the Option is vested on the date of termination (but in no event later than the expiration of the term of such Option as set forth in the Award Agreement). In the absence of a specified time in the Award Agreement, the Option will remain exercisable for twelve (12) months following the Participant's termination. Unless otherwise provided by the Administrator, if on the date of termination the Participant is not vested as to his or her entire Option, the Shares covered by the unvested portion of the Option will revert to the Plan. If after termination the Participant does not exercise any vested portion of his or her Option within the time specified herein, such vested portion of the Option will terminate, and the Shares covered by such vested portion of the Option will revert to the Plan.

(v) Death of Participant. If a Participant dies while a Service Provider, the Option may be exercised following the Participant's death within such period of time as is specified in the Award Agreement to the extent that the Option is vested on the date of death (but in no event may the option be exercised later than the expiration of the term of such Option as set forth in the Award Agreement), by the Participant's designated beneficiary, provided such beneficiary has been designated prior to Participant's death in a form acceptable to the Administrator. If no such beneficiary has been designated by the Participant, then such Option may be exercised by the personal representative of the Participant's estate or by the Person(s) to whom the Option is transferred pursuant to the Participant's will or in accordance with the laws of descent and distribution. In the absence of a specified time in the Award Agreement, the Option will remain exercisable for twelve (12) months following Participant's death. Unless otherwise provided by the Administrator, if at the time of death Participant is not vested as to his or her entire Option, the Shares covered by the unvested portion of the Option will immediately revert to the Plan. If the vested portion of the Option is not so exercised within the time specified herein, such vested portion of the Option will terminate, and the Shares covered by such vested portion of the Option will revert to the Plan.

#### 7. Restricted Stock.

(a) Grant of Restricted Stock. Subject to the terms and provisions of the Plan, the Administrator, at any time and from time to time, may grant Shares of Restricted Stock to Service Providers in such amounts as the Administrator, in its sole discretion, will determine.

(b) Restricted Stock Agreement. Each Award of Restricted Stock will be evidenced by an Award Agreement that will specify the Period of Restriction, the number of Shares granted, and such other terms and conditions as the Administrator, in its sole discretion, will determine. Unless the Administrator determines otherwise, the Company as escrow agent will hold Shares of Restricted Stock until the restrictions on such Shares have lapsed.

(c) Transferability. Except as provided in this Section 7 or the Award Agreement, Shares of Restricted Stock may not be sold, transferred, pledged, assigned, or otherwise alienated or hypothecated until the end of the applicable Period of Restriction.

(d) Other Restrictions. The Administrator, in its sole discretion, may impose such other restrictions on Shares of Restricted Stock as it may deem advisable or appropriate.

(e) Removal of Restrictions. Except as otherwise provided in this Section 7, Shares of Restricted Stock covered by each Restricted Stock grant made under the Plan will be released from escrow as soon as practicable after the last day of the Period of Restriction or at such other time as the Administrator may determine. The Administrator, in its sole discretion, may accelerate the time at which any restrictions will lapse or be removed.

(f) Voting Rights. During the Period of Restriction, Service Providers holding Shares of Restricted Stock granted hereunder may exercise full voting rights with respect to those Shares, unless the Administrator determines otherwise.

(g) Dividends and Other Distributions. During the Period of Restriction, Service Providers holding Shares of Restricted Stock will be entitled to receive all dividends and other distributions paid with respect to such Shares, unless the Administrator provides otherwise. If any such dividends or distributions are paid in Shares, the Shares will be subject to the same restrictions on transferability and forfeitability as the Shares of Restricted Stock with respect to which they were paid.

(h) Return of Restricted Stock to Company. On the date set forth in the Award Agreement, the Restricted Stock for which restrictions have not lapsed will revert to the Company and again will become available for grant under the Plan.

(i) Section 83(b) Election. If a Participant makes an election pursuant to Section 83(b) of the Code with respect to an Award of Restricted Stock, the Participant shall file, within 30 days following the date of grant, a copy of such election with the Company (directed to the Secretary thereof) and with the Internal Revenue Service, in accordance with the regulations under Section 83 of the Code. The Administrator may provide in an Award Agreement that the Award of Restricted Stock is conditioned upon the Participant's making or refraining from making an election with respect to the Award under Section 83(b) of the Code.

#### 8. Restricted Stock Units.

(a) Grant. Restricted Stock Units may be granted at any time and from time to time as determined by the Administrator. After the Administrator determines that it will grant Restricted Stock Units under the Plan, it will advise the Participant in an Award Agreement of the terms, conditions, and restrictions related to the grant, including the number of Restricted Stock Units. A Restricted Stock Unit may be granted together with a dividend equivalent right with respect to the Shares subject to the Award, which may be accumulated and may be deemed reinvested in additional stock units, as determined by the Administrator in its sole discretion. If any dividend equivalents are paid while a Restricted Stock Unit is subject to restrictions under this Section 8, or attainment of Performance Measures (as defined in Section 13 of the Plan), the dividend equivalents shall be subject to the same restrictions on transferability as the Restricted Stock Units to which they were paid, unless otherwise set forth in the Award Agreement.

(b) Vesting Criteria and Other Terms. The Administrator will set vesting criteria in its sole discretion, which, depending on the extent to which the criteria are met, will determine the number of Restricted Stock Units that will be paid out to the Participant. The Administrator may set vesting criteria based upon the achievement of Company-wide, divisional,



business unit, or individual goals (including, but not limited to, continued employment or service), applicable federal or state securities laws or any other basis determined by the Administrator in its sole discretion.

(c) Earning Restricted Stock Units. Upon meeting the applicable vesting criteria, the Participant will be entitled to receive a payout as determined by the Administrator. Notwithstanding the foregoing, at any time after the grant of Restricted Stock Units, the Administrator, in its sole discretion, may reduce or waive any vesting criteria that must be met to receive a payout.

(d) Form and Timing of Payment. Payment of earned Restricted Stock Units will be made as soon as practicable after the date(s) determined by the Administrator and set forth in the Award Agreement. The Administrator, in its sole discretion, may only settle earned Restricted Stock Units in cash, Shares, or a combination of both. Any cash payment of a Restricted Stock Unit shall be made based upon the Fair Market Value of the Common Stock, determined on such date or over such time period as determined by the Administrator.

(e) Cancellation. On the date set forth in the Award Agreement, all unearned Restricted Stock Units will be forfeited to the Company.

#### 9. Stock Appreciation Rights.

(a) Grant of Stock Appreciation Rights. Subject to the terms and conditions of the Plan, a Stock Appreciation Right may be granted to Service Providers at any time and from time to time as will be determined by the Administrator, in its sole discretion.

(b) Number of Shares. The Administrator will have complete discretion to determine the number of Stock Appreciation Rights granted to any Service Provider.

(c) Exercise Price and Other Terms. The per share exercise price for the Shares to be issued pursuant to exercise of a Stock Appreciation Right will be determined by the Administrator and will be no less than one hundred percent (100%) of the Fair Market Value per Share on the date of grant. Otherwise, the Administrator, subject to the provisions of the Plan, will have sole discretion to determine the terms and conditions of Stock Appreciation Rights granted under the Plan.

(d) Stock Appreciation Right Agreement. Each Stock Appreciation Right grant will be evidenced by an Award Agreement that will specify the exercise price, the term of the Stock Appreciation Right, the conditions of exercise, vesting criteria and such other terms and conditions as the Administrator, in its sole discretion, will determine.

(e) Expiration of Stock Appreciation Rights. A Stock Appreciation Right granted under the Plan will expire upon the date determined by the Administrator, in its sole discretion, and set forth in the Award Agreement. Notwithstanding the foregoing, the rules of Section 6(b) of the Plan relating to the maximum term and Section 6(d) of the Plan relating to exercise also will apply to Stock Appreciation Rights.

(f) Payment of Stock Appreciation Right Amount. Subject to such terms and

conditions as shall be specified in an Award Agreement, a vested Stock Appreciation Right may be exercised in whole or in part at any time during the term thereof by notice in the form required by the Company and payment of any exercise price. Upon exercise of a Stock Appreciation Right, a Participant will be entitled to receive payment from the Company in an amount determined by multiplying:

- (i) The difference between the Fair Market Value of a Share on the date of exercise over the exercise price; by
- (ii) The number of Shares with respect to which the Stock Appreciation Right is exercised.

At the discretion of the Administrator, the payment upon Stock Appreciation Right exercise may be in cash, in Shares of equivalent value, or in some combination thereof.

10. Performance Units and Performance Shares.

(a) Grant of Performance Units/Shares. Performance Units and Performance Shares may be granted to Service Providers at any time and from time to time, as will be determined by the Administrator, in its sole discretion. The Administrator will have sole discretion in determining the number of Performance Units and Performance Shares granted to each Participant.

(b) Value of Performance Units/Shares. Each Performance Unit will have an initial value that is established by the Administrator on or before the date of grant. Each Performance Share will have an initial value equal to the Fair Market Value of a Share on the date of grant.

(c) Performance Objectives and Other Terms. The Administrator will set performance objectives or other vesting provisions (including, without limitation, continued status as a Service Provider) in its sole discretion which, depending on the extent to which they are met, will determine the number or value of Performance Units/Shares that will be paid out to the Service Providers. The time period during which the performance objectives or other vesting provisions must be met will be called the "Performance Period." Each Award of Performance Units/Shares will be evidenced by an Award Agreement that will specify the Performance Period, and such other terms and conditions as the Administrator, in its sole discretion, will determine. The Administrator may set performance objectives based upon the achievement of Company-wide, divisional, business unit or individual goals (including, but not limited to, continued employment or service), applicable federal or state securities laws, or any other basis determined by the Administrator in its sole discretion.

(d) Earning of Performance Units/Shares. Unless otherwise set forth in an Award Agreement, after the applicable Performance Period has ended, the holder of Performance Units/Shares will be entitled to receive a payout of the number of Performance Units/Shares earned by the Participant over the Performance Period, to be determined as a function of the extent to which the corresponding performance objectives or other vesting provisions have been achieved. After the grant of a Performance Unit/Share, the Administrator, in its sole discretion, may reduce or waive any performance objectives or other vesting provisions for such Performance Unit/Share.

(e) Form and Timing of Payment of Performance Units/Shares. Payment of earned Performance Units/Shares will be made as soon as practicable after the expiration of the applicable Performance Period. The Administrator, in its sole discretion, may pay earned Performance Units/Shares in the form of cash, in Shares (which have an aggregate Fair Market Value equal to the value of the earned Performance Units/Shares at the close of the applicable Performance Period) or in a combination thereof. Any Shares paid to Participant under this Section 10(e) may be subject to any restrictions deemed appropriate by the Administrator.

(f) Cancellation of Performance Units/Shares. On the date set forth in the Award Agreement, all unearned or unvested Performance Units/Shares will be forfeited to the Company, and again will be available for grant under the Plan.

11. Outside Director Limitations.

(a) Cash-Settled Awards. No Outside Director may be granted, in any Fiscal Year, cash-settled Awards with a grant date fair value (determined in accordance with U.S. generally accepted accounting principles) of more than \$500,000.

(b) Stock-Settled Awards. No Outside Director may be granted, in any Fiscal Year, stock-settled Awards with a grant date fair value (determined in accordance with U.S. generally accepted accounting principles) of more than \$500,000.

12. Other Cash-Based Awards and Other Stock-Based Awards.

(a) Other Cash-Based and Stock-Based Awards. The Administrator may grant other types of equity-based or equity-related Awards not otherwise described by the terms of this Plan (including the grant or offer for sale of unrestricted Shares) in such amounts and subject to such terms and conditions, as the Administrator shall determine. Such Awards may involve the transfer of actual shares of Common Stock to a Participant, or payment in cash or otherwise of amounts based on the value of shares of Common Stock. In addition, the Administrator, at any time and from time to time, may grant Other Cash-Based Awards to a Service Provider in such amounts and upon such terms as the Administrator shall determine, in its sole discretion.

(b) Value of Other Cash-Based Awards and Other Stock-Based Awards. Each Other Stock-Based Award shall be expressed in terms of Shares or units based on Shares, as determined by the Administrator, in its sole discretion. Each Other Cash-Based Award shall specify a payment amount or payment range as determined by the Administrator, in its sole discretion. If the Administrator exercises its discretion to establish performance goals, the value of Other Cash-Based Awards that shall be paid to the Participant will depend on the extent to which such performance goals are met.

(c) Payment of Other Cash-Based Awards and Other Stock-Based Awards. Payment, if any, with respect to Other Cash-Based Awards and Other Stock-Based Awards shall be made in accordance with the terms of the Award, in cash or Shares as the Administrator determines.

13. Section 162(m) Awards.

(a) Awards Granted Under Code Section 162(m). Any Restricted Stock, Restricted Stock Unit, Performance Share, Performance Unit, Other Stock Based-Award or Other Cash Based-Award may be granted as a Section 162(m) Award. Such an Award will be administered by a Committee of two (2) or more “outside directors” within the meaning of Section 162(m) of the Code, and must comply with the following additional requirements, which shall control over any other provision that pertains to such Award.

(b) Performance Measures.

(i) Each Section 162(m) Award shall be based upon the attainment of specified levels of pre-established, objective “Performance Measures” (as defined in Section 13(b)(ii) below) that are intended to satisfy the performance based compensation exemption requirements of Section 162(m) of the Code and the regulations promulgated thereunder. Further, at the sole discretion of the Committee, an Award also may be subject to goals and restrictions in addition to the Performance Measures.

(ii) “Performance Measures” means the measures of performance of the Company and its Subsidiaries used to determine a Participant’s entitlement to an Award under the Plan. Such performance measures shall have the same meanings as used in the Company’s financial statements, or, if such terms are not used in the Company’s financial statements, they shall have the meaning applied pursuant to generally accepted accounting principles, or as used generally in the Company’s industry. Performance Measures shall be calculated with respect to the Company and each Subsidiary consolidated therewith for financial reporting purposes or such division or other business unit as may be selected by the Committee. For purposes of the Plan, the Performance Measures shall be calculated in accordance with generally accepted accounting principles to the extent applicable, but, unless otherwise determined by the Committee, prior to the accrual or payment of any Award under this Plan for the same performance period and excluding the effect (whether positive or negative) of any change in accounting standards or any extraordinary, unusual or nonrecurring item, as determined by the Committee, occurring after the establishment of the performance goals. Performance Measures shall be based on one or more of the criteria set forth in Exhibit A which is hereby incorporated by reference, as determined by the Committee.

(iii) For each Section 162(m) Award, the Committee shall (A) select the Service Provider who shall be eligible to receive a Section 162(m) Award, (B) determine the applicable performance period, (C) determine the target levels of the Company or Subsidiary Performance Measures, and (D) determine the number of Shares or cash or other property (or combination thereof) subject to an Award to be paid to each selected Participant. The Committee shall make the foregoing determinations prior to the commencement of services to which an Award relates (or within the permissible time period established under Section 162(m) of the Code) and while the outcome of the performance goals and targets are uncertain.

(c) Attainment of Section 162(m) Goals.

(i) After each performance period, the Committee shall certify in writing (which may include the written minutes for any meeting of the Committee): (A) if the Company has attained the performance targets, and (B) the number of shares pursuant to the Award that are to become freely transferable, if applicable, or the cash or other property payable under the Award. The Committee shall have no discretion to waive all or part of the conditions, goals and restrictions applicable to the receipt of full or partial payment of an Award except in the case of a Change in Control of the Company or the death or Disability of a Participant.

(ii) Notwithstanding the foregoing, the Committee may, in its sole discretion, reduce any Award based on such factors as may be determined by the Committee, including, without limitation, a determination by the Committee that such a reduction is appropriate in light of pay practices of competitors, or the performance of the Company, a Subsidiary or a Participant relative to the performance of competitors, or performance with respect to the Company's strategic business goals.

(d) Individual Participant Limitations. Subject to adjustment as provided in Section 16 of the Plan, the maximum number of Shares with respect to which Options or Stock Appreciation Rights may be granted to any one individual under the Plan during any calendar year shall be 620,800 Shares. Subject to adjustment as provided in Section 16 of the Plan, the maximum number of Shares subject to Section 162(m) Awards (other than Options and Stock Appreciation Rights) that may be paid to any one individual in respect of any calendar year if the applicable Performance Goals are attained is 620,800 Shares. The maximum cash amount that may be paid pursuant to Section 162(m) Awards (other than Options and Stock Appreciation Rights) to any one individual in respect of any calendar year if the applicable Performance Goals are attained is \$3,000,000. In the case of Performance Goals based on performance periods beginning and ending in different calendar years, the number of Shares or cash amount which is paid in respect of each calendar year during the performance period shall be determined by multiplying the total number of Shares or cash amount, as applicable, paid for the performance period by a fraction, of which (i) the numerator is the number of days during the performance period in that particular calendar year, and (ii) the denominator is the total number of days during the performance period. The limitations in this Section 13(d) shall be interpreted and applied in a manner consistent with Section 162(m) of the Code and the regulations thereunder. If an Award is cancelled, the cancelled Award shall continue to be counted towards the applicable limitations.

14. Leaves of Absence/Transfer Between Locations. Unless the Administrator provides otherwise, vesting of Awards granted hereunder will be suspended during any unpaid leave of absence. A Participant will not cease to be an Employee in the case of (i) any leave of absence approved by the Company or (ii) transfers between locations of the Company or between the Company, its Parent, or any Subsidiary. For purposes of Incentive Stock Options, no such leave may exceed three (3) months, unless reemployment upon expiration of such leave is guaranteed by statute or contract. If reemployment upon expiration of a leave of absence approved by the Company is not so guaranteed, then six (6) months following the first (1st) day of such leave any Incentive Stock Option held by the Participant will cease to be treated as an Incentive Stock Option and will be treated for tax purposes as a Nonstatutory Stock Option.

15. Transferability of Awards. Unless determined otherwise by the Administrator, an Award may not be sold, pledged, assigned, hypothecated, transferred, or disposed of in any manner other than by will or by the laws of descent or distribution and may be exercised, during the lifetime of the Participant, only by the Participant. If the Administrator makes an Award transferable, such Award will contain such additional terms and conditions as the Administrator deems appropriate.

16. Adjustments; Dissolution or Liquidation; Merger or Change in Control.

(a) Adjustments. In the event that any dividend or other distribution (whether in the form of cash, Shares, other securities, or other property), recapitalization, stock split, reverse stock split, reorganization, merger, consolidation, split-up, spin-off, combination, repurchase, or exchange of Shares or other securities of the Company, or other change in the corporate structure of the Company affecting the Shares occurs, the Administrator, in order to prevent diminution or enlargement of the benefits or potential benefits intended to be made available under the Plan, will adjust the number and class of Shares that may be delivered under the Plan and/or the number, class, and price of Shares covered by each outstanding Award, and the numerical Share limits in Section 3 of the Plan.

(b) Dissolution or Liquidation. In the event of the proposed dissolution or liquidation of the Company, the Administrator will notify each Participant as soon as practicable prior to the effective date of such proposed transaction. To the extent it has not been previously exercised, an Award will terminate immediately prior to the consummation of such proposed action.

(c) Change in Control. In the event of a merger of the Company with or into another corporation or other entity or a Change in Control, each outstanding Award will be treated as the Administrator determines in its sole discretion, subject to the terms of this Section 16(c) set forth below, including, without limitation, that each Award be assumed or an equivalent option or right substituted by the successor corporation or a Parent or Subsidiary of the successor corporation. The Administrator will not be required to treat all Awards similarly in the transaction.

In the event that the successor corporation does not assume or substitute for the Award (or portion thereof), the Participant will fully vest in and have the right to exercise such outstanding Option and Stock Appreciation Right, including Shares as to which such Award would not otherwise be vested or exercisable, all restrictions on such Restricted Stock and Restricted Stock Units will lapse, and, with respect to such Awards with performance-based vesting, all performance goals or other vesting criteria will be deemed achieved at one hundred percent (100%) of target levels and all other terms and conditions met. In addition, if an Option or Stock Appreciation Right is not assumed or substituted in the event of a merger or Change in Control, the Administrator will notify the Participant in writing or electronically that such Option or Stock Appreciation Right will be exercisable for a period of time determined by the Administrator in its sole discretion, and the Option or Stock Appreciation Right will terminate upon the expiration of such period.

For the purposes of this subsection (c), an Award will be considered assumed if, following the Change in Control, the Award confers the right to purchase or receive, for each Share subject to the Award immediately prior to the Change in Control, if any, the consideration (whether stock, cash, or other securities or property) received in the Change in Control by holders of Common Stock for each Share held on the effective date of the transaction (and if holders were offered a choice of consideration, the type of consideration chosen by the holders of a majority of the outstanding Shares); provided, however, that if such consideration received in the Change in Control is not solely common stock of the successor corporation or its Parent, the Administrator may, with the consent of the successor corporation, provide for the consideration to be received upon the exercise of an Option or Stock Appreciation Right or upon the payout of a Restricted Stock Unit, Performance Unit, Performance Share, and Other Stock-Based Award, for each Share subject to such Award, to be solely common stock of the successor corporation or its Parent equal in fair market value to the per share consideration received by holders of Common Stock in the Change in Control.

Notwithstanding anything in this Section 16(c) to the contrary, an Award that vests, is earned or paid-out upon the satisfaction of one or more performance goals will not be considered assumed if the Company or its successor modifies any of such performance goals without the Participant's consent; provided, however, a modification to such performance goals only to reflect the successor corporation's post-Change in Control corporate structure will not be deemed to invalidate an otherwise valid Award assumption.

17. Tax.

(a) Withholding Requirements. Prior to the delivery of any Shares or cash pursuant to an Award (or exercise thereof) or such earlier time as any tax withholding obligations are due, the Company will have the power and the right to deduct or withhold, or require a Participant to remit to the Company, an amount sufficient to satisfy federal, state, local, foreign or other taxes (including the Participant's FICA or other social insurance contribution obligation) required to be withheld with respect to such Award (or exercise thereof).

(b) Withholding Arrangements. The Administrator, in its sole discretion and pursuant to such procedures as it may specify from time to time, may permit a Participant to satisfy such tax withholding obligation, in whole or in part by (without limitation) (i) paying cash (including cash from the sale of Shares issued to the Participant at exercise), (ii) electing to have the Company withhold otherwise deliverable Shares having a fair market value equal to the amount required to be withheld or (iii) delivering to the Company already-owned Shares having a fair market value equal to the amount required to be withheld. The fair market value of the Shares to be withheld or delivered will be determined as of the date that the taxes are required to be withheld. If withholding or accepting delivery of Shares will result in adverse accounting consequences to the Company, then the Administrator may choose to not permit such withholding or delivery.

(c) Compliance With Section 409A of the Code. Awards will be designed and operated in such a manner that they are either exempt from the application of, or comply with, the requirements of Section 409A of the Code such that the grant, payment, settlement or deferral will not be subject to the additional tax or interest applicable under Section 409A of the

Code. The Plan and each Award Agreement under the Plan is intended to meet the requirements of Section 409A of the Code and will be construed and interpreted in accordance with such intent. To the extent that an Award or payment, or the settlement or deferral thereof, is subject to Section 409A of the Code the Award will be granted, paid, settled or deferred in a manner that will meet the requirements of Section 409A of the Code, such that the grant, payment, settlement or deferral will not be subject to the additional tax or interest applicable under Section 409A of the Code. Notwithstanding anything in the Plan or an Award Agreement to the contrary, in the event that any provision of the Plan or an Award Agreement is determined by the Administrator, in its sole discretion, to not comply with the requirements of Section 409A of the Code or an exemption thereto, the Administrator shall, in its sole discretion, have the authority to take such actions and to make such interpretations or changes to the Plan or an Award Agreement as the Administrator deems necessary, regardless of whether such actions, interpretations, or changes may adversely affect a Participant, subject to the limitations, if any, of applicable law. In no event whatsoever shall the Company be liable for any additional tax, interest or penalties that may be imposed on any Participant by Section 409A of the Code or any damages for failing to comply with Section 409A of the Code.

18. General Provisions.

(a) No Effect on Employment or Service. Neither the Plan nor any Award will confer upon a Participant any right with respect to continuing the Participant's relationship as a Service Provider with the Company or its Parent, Subsidiary or Affiliate, as applicable, nor will they interfere in any way with the Participant's right or the right of the Company or its Parent, Subsidiary or Affiliate to terminate such relationship at any time, with or without cause, to the extent permitted by Applicable Laws.

(b) No Rights as Stockholder. A Participant shall have no rights as a holder of Shares with respect to any unissued securities covered by an Award until the date the Participant becomes the holder of record of such securities.

(c) Fractional Shares. In the case of any fractional share or unit resulting from the grant, vesting, payment or crediting of dividends or dividend equivalents under an Award, the Administrator shall have the discretionary authority to (i) disregard such fractional share or unit, (ii) round such fractional share or unit to the nearest lower or higher whole share or unit or (iii) convert such fractional share or unit into a right to receive a cash payment.

(d) Other Compensation and Benefit Plans. The amount of any compensation deemed to be received by a Participant pursuant to an Award shall not constitute includable compensation for purposes of determining the amount of benefits to which a Participant is entitled under any other compensation or benefit plan or program of the Company or any Subsidiary, including, without limitation, under any bonus, pension, profit-sharing, life insurance, salary continuation or severance benefits plan, except to the extent specifically provided by the terms of any such plan.

(e) Plan Binding on Transferees. The Plan shall be binding upon the Company, its transferees and assigns, and the Participant, the Participant's executor, administrator and permitted transferees and beneficiaries. In addition, all obligations of the



Company under this Plan with respect to Awards granted hereunder shall be binding on any successor to the Company, whether the existence of such successor is the result of a direct or indirect purchase, merger, consolidation, or otherwise, of all or substantially all of the business and/or assets of the Company.

(f) Clawback. Any amounts paid hereunder shall be subject to recoupment in accordance with The Dodd–Frank Wall Street Reform and Consumer Protection Act and any implementing regulations thereunder, any “clawback” policy adopted by the Company or as is otherwise required by applicable law or stock exchange listing condition.

(g) Foreign Jurisdictions. The Administrator may adopt, amend and terminate such arrangements and grant such Awards, not inconsistent with the intent of the Plan, as it may deem necessary or desirable to comply with any tax, securities, regulatory or other laws of other jurisdictions with respect to Awards that may be subject to such laws. The terms and conditions of such Awards may vary from the terms and conditions that would otherwise be required by the Plan solely to the extent the Administrator deems necessary for such purpose. Moreover, the Board may approve such supplements to or amendments, restatements or alternative versions of the Plan, not inconsistent with the intent of the Plan, as it may consider necessary or appropriate for such purposes, without thereby affecting the terms of the Plan as in effect for any other purpose.

(h) No Guarantee of Tax Consequences. Neither the Company, the Board, the Committee, the Administrator nor any other Person make any commitment or guarantee that any federal, state, local or foreign tax treatment will apply or be available to any Participant or any other Person hereunder.

(i) Severability. If any provision of the Plan or any Award Agreement shall be determined to be illegal or unenforceable by any court of law in any jurisdiction, the remaining provisions hereof and thereof shall be severable and enforceable in accordance with their terms, and all provisions shall remain enforceable in any other jurisdiction.

(j) Date of Grant. The date of grant of an Award will be, for all purposes, the date on which the Administrator makes the determination granting such Award, or such other later date as is determined by the Administrator. Notice of the determination will be provided to each Participant within a reasonable time after the date of such grant.

(k) Change in Time Commitment. In the event a Participant’s regular level of time commitment in the performance of the Participant’s services for the Company and any Affiliates is reduced (for example, and without limitation, if the Participant is an employee of the Company and the employee has a change in status from a full-time employee to a part-time employee) after the date of grant of any Award to the Participant, the Administrator has the right in its sole discretion to (i) make a corresponding reduction in the number of shares subject to any portion of such Award that is scheduled to vest or become payable after the date of such change in time commitment, and (ii) in lieu of or in combination with such a reduction, extend the vesting or payment schedule applicable to such Award. In the event of any such reduction, the Participant will have no right with respect to any portion of the Award that is so reduced or extended.

(l) Incentive Arrangement. The Plan is designed to provide an on-going, pecuniary incentive for Participants to produce their best efforts to increase the value of the Company. The Plan is not intended to provide retirement income or to defer the receipt of payments hereunder to the termination of a Participant's employment or beyond. The Plan is thus intended not to be a pension or welfare benefit plan that is subject to Employee Retirement Income Security Act of 1974 ("ERISA"), and shall be construed accordingly. All interpretations and determinations hereunder shall be made on a basis consistent with the Plan's status as not an employee benefit plan subject to ERISA.

(m) Unfunded Plan. The adoption of the Plan and any reservation of Shares or cash amounts by the Company to discharge its obligations hereunder shall not be deemed to create a trust or other funded arrangement. Except upon the issuance of Shares pursuant to an Award, any rights of a Participant under the Plan shall be those of a general unsecured creditor of the Company, and neither a Participant nor the Participant's permitted transferees or estate shall have any other interest in any assets of the Company by virtue of the Plan. Notwithstanding the foregoing, the Company shall have the right to implement or set aside funds in a grantor trust, subject to the claims of the Company's creditors or otherwise, to discharge its obligations under the Plan.

19. Term of Plan. Subject to Section 23 of the Plan, the Plan will become effective upon the later to occur of (i) its adoption by the Board or (ii) the business day immediately prior to the Registration Date. It will continue in effect for a term of ten (10) years from the date adopted by the Board, unless terminated earlier under Section 20 of the Plan, provided, however, that Awards granted prior to such termination date shall extend beyond such date.

20. Amendment and Termination of the Plan.

(a) Amendment and Termination. The Administrator may at any time amend, alter, suspend or terminate the Plan.

(b) Stockholder Approval. The Company will obtain stockholder approval of any Plan amendment to the extent necessary to comply with Applicable Laws.

(c) Effect of Amendment or Termination. No amendment, alteration, suspension or termination of the Plan will impair the rights of any Participant, unless mutually agreed otherwise between the Participant and the Administrator, which agreement must be in writing and signed by the Participant and the Company. Termination of the Plan will not affect the Administrator's ability to exercise the powers granted to it hereunder with respect to Awards granted under the Plan prior to the date of such termination.

21. Conditions Upon Issuance of Shares.

(a) Legal Compliance. Shares will not be issued pursuant to the exercise of an Award unless the exercise of such Award and the issuance and delivery of such Shares will comply with Applicable Laws and will be further subject to the approval of counsel for the Company with respect to such compliance.

(b) Investment Representations. As a condition to the exercise of an Award, the Company may require the Person exercising such Award to represent and warrant at the time of any such exercise that the Shares are being purchased only for investment and without any present intention to sell or distribute such Shares if, in the opinion of counsel for the Company, such a representation is required.

22. Inability to Obtain Authority. The inability of the Company to obtain authority from any regulatory body having jurisdiction or to complete or comply with the requirements of any registration or other qualification of the Shares under any state, federal or foreign law or under the rules and regulations of the Securities and Exchange Commission, the stock exchange on which Shares of the same class are then listed, or any other governmental or regulatory body, which authority, registration, qualification or rule compliance is deemed by the Company's counsel to be necessary or advisable for the issuance and sale of any Shares hereunder, will relieve the Company of any liability in respect of the failure to issue or sell such Shares as to which such requisite authority, registration, qualification or rule compliance will not have been obtained.

23. Stockholder Approval. The Plan will be subject to approval by the stockholders of the Company within twelve (12) months after the date the Plan is adopted by the Board. Such stockholder approval will be obtained in the manner and to the degree required under Applicable Laws.

24. Governing Law. The Plan and all rights hereunder shall be subject to and interpreted in accordance with the laws of the State of Delaware, without reference to the principles of conflicts of laws, and to applicable Federal securities laws.

## EXHIBIT A

### PERFORMANCE MEASURES

Section 162(m) Awards shall be based on the attainment of objective performance goals that are established by the Committee and relate to one or more Performance Measures, in each case on specified date or over any period, up to 10 years, as determined by the Committee.

“Performance Measures” means the following business criteria (or any combination thereof) with respect to one or more of the Company, any Subsidiary or any division or operating unit thereof:

- pre-tax income;
- after-tax income;
- net income (meaning net income as reflected in the Company’s financial reports for the applicable period, on an aggregate, diluted and/or per share basis, or economic net income);
- operating income or profit;
- adjusted EBITDA;
- customer installations;
- billings;
- adjusted billings;
- billings on a constant currency basis;
- cash flow, free cash flow, cash flow return on investment (discounted or otherwise), net cash provided by operations or cash flow in excess of cost of capital;
- earnings per share (basic or diluted);
- return on equity;
- cash, funds or earnings available for distribution;
- appreciation in the fair market value of the Common Stock;
- operating expenses;
- implementation or completion of critical projects or processes;
- return on investment;

- total return to stockholders (meaning the aggregate Common Stock price appreciation and dividends paid (assuming full reinvestment of dividends) during the applicable period);
- net earnings growth;
- return measures (including but not limited to return on assets, capital, equity, sales, or revenues);
- increase in revenues;
- the Company's published ranking against its peer group of companies based on total stockholder return;
- net earnings;
- changes (or the absence of changes) in the per share price of the Common Stock;
- earnings before or after any one or more of the following items: interest, taxes, depreciation or amortization, as reflected in the Company's financial reports for the applicable period;
- total revenue growth (meaning the increase in total revenues after the date of grant of an award and during the applicable period, as reflected in the Company's financial reports for the applicable period);
- economic value created;
- operating margin or profit margin;
- share price or total shareholder return;
- cost targets, reductions and savings, productivity and efficiencies;
- strategic business criteria, consisting of one or more objectives based on meeting objectively determinable criteria: specified market penetration, geographic business expansion, investor satisfaction, employee satisfaction, human resources management, supervision of litigation, information technology, and goals relating to acquisitions, divestitures, joint ventures and similar transactions, and budget comparisons;
- objectively determinable personal or professional objectives, including any of the following performance goals: the implementation of policies and plans, the negotiation of transactions, the development of long term business goals, formation of joint ventures, research or development collaborations, and the completion of other corporate transactions; and
- any combination of, or a specified increase or improvement in, any of the foregoing.

Where applicable, the Performance Measures may be expressed in terms of attaining a specified level of the particular criteria or the attainment of a percentage increase or decrease in the particular criteria, and may be applied to one or more of the Company, a Subsidiary or affiliate, or a division or strategic business unit of the Company, or may be applied to the performance of the Company relative to a market index, a group of other companies or a combination thereof, all as determined by the Committee.

The Performance Measures may include a threshold level of performance below which no payment shall be made (or no vesting shall occur), levels of performance at which specified payments shall be made (or specified vesting shall occur), and a maximum level of performance above which no additional payment shall be made (or at which full vesting shall occur).

Except as otherwise expressly provided, all financial terms are used as defined under Generally Accepted Accounting Principles ("GAAP") and all determinations shall be made in accordance with GAAP, as applied by the Company in the preparation of its periodic reports to stockholders.

To the extent permitted by Section 162(m) of the Code, unless the Committee provides otherwise at the time of establishing the performance goals, for each fiscal year of the Company, the Committee shall have the authority to make equitable adjustments to the Performance Measures in recognition of unusual or non-recurring events affecting the Company or any Subsidiary or affiliate or the financial statements of the Company or any Subsidiary or affiliate and may provide for objectively determinable adjustments, as determined in accordance with GAAP, to any of the Performance Measures described above for one or more of the items of gain, loss, profit or expense: (A) determined to be extraordinary or unusual in nature or infrequent in occurrence, (B) related to the disposal of a segment of a business, (C) related to a change in accounting principle under GAAP or a change in applicable laws or regulations, (D) related to discontinued operations that do not qualify as a segment of a business under GAAP, and (E) attributable to the business operations of any entity acquired by the Company during the Fiscal Year.

**ALTAIR ENGINEERING INC.**  
**2017 EQUITY INCENTIVE PLAN**  
**STOCK OPTION AGREEMENT**

Unless otherwise defined herein, the terms defined in the Altair Engineering Inc. 2017 Equity Incentive Plan (the "Plan") will have the same defined meanings in this Stock Option Agreement, including the Notice of Stock Option Grant (the "Notice of Grant"), the Terms and Conditions of Stock Option Grant, attached hereto as Exhibit A, and the Non-US Country-Specific Terms and Conditions, attached hereto as Exhibit B (collectively this "Agreement").

**NOTICE OF STOCK OPTION GRANT**

**Participant:** \_\_\_\_\_

Participant has been granted an Option to purchase Common Stock of Altair Engineering Inc. (the "Company"), subject to the terms and conditions of the Plan and this Agreement, as follows:

Grant Number \_\_\_\_\_

Date of Grant \_\_\_\_\_

Vesting Commencement Date \_\_\_\_\_

Number of Shares Granted \_\_\_\_\_

Exercise Price per Share \$ \_\_\_\_\_

Total Exercise Price \$ \_\_\_\_\_

Type of Option \_\_\_\_\_ Incentive Stock Option  
\_\_\_\_\_ Nonstatutory Stock Option

Term/Expiration Date \_\_\_\_\_

**Vesting Schedule:**

Subject to accelerated vesting as set forth below or in the Plan, this Option will be exercisable, in whole or in part, in accordance with the following schedule:

The Option shall vest with respect to twenty-five percent (25%) of the shares of Class A common stock ("Shares") underlying the Option on the one (1) year anniversary of the Vesting Commencement Date; and the balance shall vest with respect to twenty-five percent (25%) of the Shares underlying the Option on each anniversary of the Vesting Commencement Date thereafter (such that the Option shall be fully vested on the fourth anniversary of the Vesting Commencement Date), subject to Participant continuing to be a Service Provider through each such date.

Termination Period:

This Option will be exercisable for three (3) months after Participant ceases to be a Service Provider, unless such termination is due to Participant's death or Disability, in which case this Option will be exercisable for twelve (12) months after Participant ceases to be a Service Provider. Notwithstanding the foregoing, in the event that Participant is terminated for Cause, this Option shall immediately terminate on the date of such termination and shall not be exercisable for any period following such date. In no event may this Option be exercised after the Term/Expiration Date as provided above and may be subject to earlier termination as provided in Section 16(c) of the Plan.

For purposes of this Option, Participant's status as a Service Provider will be considered terminated as of the date Participant is no longer actively providing services to the Company or any Parent or Subsidiary of the Company (regardless of the reason for such termination and whether or not later found to be invalid or in breach of employment laws in the jurisdiction where Participant is employed or the terms of Participant's employment or service agreement, if any), and unless otherwise expressly provided in this Agreement or determined by the Company, (i) Participant's right to vest in this Option under the Plan, if any, will terminate as of such date and will not be extended by any notice period (e.g., Participant's period of service would not include any contractual notice period or any period of "garden leave" or similar period mandated under employment laws in the jurisdiction where Participant is employed or the terms of Participant's employment or service agreement, if any); and (ii) the period (if any) during which Participant may exercise this Option after such termination of Participant as a Service Provider will commence on the date Participant ceases to actively provide services and will not be extended by any notice period mandated under employment laws in the jurisdiction where Participant is employed or terms of Participant's employment or service agreement, if any; the Administrator shall have the sole discretion to determine when Participant is no longer actively providing services for purposes of his or her Option grant (including whether Participant may still be considered to be providing services while on a leave of absence).

Participant has reviewed the Plan and this Agreement in their entirety, has had an opportunity to obtain the advice of counsel prior to executing this Agreement and fully understands all provisions of the Plan and this Agreement. Participant hereby agrees to accept as binding, conclusive and final all decisions or interpretations of the Administrator upon any questions relating to the Plan and this Agreement. Participant further agrees to notify the Company upon any change in the residence address indicated above.



## EXHIBIT A

### TERMS AND CONDITIONS OF STOCK OPTION GRANT

1. Grant of Option. The Company hereby grants to Participant named in the Notice of Grant (“Participant”) an option (the “Option”) to purchase the number of Shares, as set forth in the Notice of Grant, at the exercise price per Share set forth in the Notice of Grant (the “Exercise Price”), subject to all of the terms and conditions in this Agreement and the Plan, which are incorporated herein by reference. In the event of a conflict between the terms and conditions of the Plan and the terms and conditions of this Agreement, the terms and conditions of the Plan will prevail.

If designated in the Notice of Grant as an Incentive Stock Option (“ISO”) for a U.S. taxpayer, this Option is intended to qualify as an ISO under Section 422 of the U.S. Internal Revenue Code of 1986, as amended (the “Code”). However, if this Option is intended to be an ISO, to the extent that it exceeds the US\$100,000 rule of Section 422(d) of the Code it will be treated as a Nonstatutory Stock Option (“NSO”). Further, if for any reason this Option (or portion thereof) will not qualify as an ISO, then, to the extent of such nonqualification, such Option (or portion thereof) shall be regarded as a NSO granted under the Plan. In no event will the Administrator, the Company or any Parent or Subsidiary of the Company or any of their respective employees or directors have any liability to Participant (or any other person) due to the failure of the Option to qualify for any reason as an ISO.

2. Vesting Schedule. Except as provided in Section 3 of this Agreement, the Option awarded by this Agreement will vest in accordance with the vesting provisions set forth in the Notice of Grant. Shares scheduled to vest on a certain date or upon the occurrence of a certain condition will not vest in Participant in accordance with any of the provisions of this Agreement, unless Participant will have been continuously a Service Provider from the Date of Grant until the date such vesting occurs.

3. Administrator Discretion. The Administrator, in its sole discretion, may accelerate the vesting of the balance, or some lesser portion of the balance, of the unvested Option at any time, subject to the terms of the Plan. If so accelerated, such Option will be considered as having vested as of the date specified by the Administrator.

#### 4. Exercise of Option.

(a) Right to Exercise. This Option may be exercised only within the term set out in the Notice of Grant, and may be exercised during such term only in accordance with the Plan and the terms of this Agreement.

(b) Method of Exercise. This Option is exercisable by delivery of an exercise notice, in the form attached as Exhibit C (the “Exercise Notice”) or in a manner and pursuant to such procedures as the Administrator may determine, which will state the election to exercise the Option, the number of Shares in respect of which the Option is being exercised (the “Exercised Shares”), and such other representations and agreements as may be required by the Company pursuant to the provisions of the Plan. The Exercise Notice will be completed by Participant and delivered to the Company. The Exercise Notice will be accompanied by payment of the

aggregate Exercise Price as to all Exercised Shares together with any Tax-Related Items (as described in Section 6(a) of this Agreement). This Option will be deemed to be exercised upon receipt by the Company of such fully executed Exercise Notice accompanied by the aggregate Exercise Price. Notwithstanding the foregoing, no Exercised Shares shall be issued unless such exercise and issuance complies with the requirements relating to the administration of stock option plans and other applicable equity plans under U.S. state corporate laws, U.S. federal and state securities laws, the Code, any stock exchange or quotation system on which the Common Stock is listed or quoted, and the applicable laws of any foreign country or jurisdiction where stock grants or other applicable equity grants are made under the Plan; assuming such compliance, for income tax purposes the Exercised Shares shall be considered transferred to Participant on the date the Option is exercised with respect to such Exercised Shares.

5. Method of Payment. Payment of the aggregate Exercise Price will be by any of the following, or a combination thereof, at the election of Participant:

(a) cash;

(b) check;

(c) consideration received by the Company under a formal cashless exercise program adopted by the Company in connection with the Plan; or

(d) subject to the sole discretion of the Administrator, surrender of other Shares which have a Fair Market Value on the date of surrender equal to the aggregate Exercise Price of the Exercised Shares, provided that accepting such Shares will not result in any adverse accounting consequences to the Company, or such other consideration and method of payment for the issuance of Shares to the extent permitted by the Plan and Applicable Law.

6. Tax Obligations.

(a) Responsibility for Taxes. Participant acknowledges that, regardless of any action taken by the Company or, if different, Participant's employer (the "Employer"), the ultimate liability for all income tax, social insurance, payroll tax, fringe benefits tax, payment on account or other tax-related items related to Participant's participation in the Plan and legally applicable to Participant ("Tax-Related Items"), is and remains Participant's responsibility and may exceed the amount actually withheld by the Company or the Employer. Further, notwithstanding any contrary provision of this Agreement, no Shares will be issued to Participant, unless and until satisfactory arrangements (as determined by the Administrator) will have been made by Participant with respect to the payment of any Tax-Related Items which the Company determines must be withheld with respect to such Shares. In addition, if Participant is subject to Tax-Related Items in more than one jurisdiction, Participant acknowledges that the Company and/or the Employer (or former employer, as applicable) may be required to withhold or account for Tax-Related Items in more than one jurisdiction. Participant further acknowledges that the Company and/or the Employer (i) make no representations or undertakings regarding the treatment of any Tax-Related Items in connection with any aspect of the Option, including, but not limited to, the grant, vesting or exercise of the Option, the subsequent sale of Shares acquired pursuant to such exercise and the receipt of any dividends; and (ii) do not commit to and are under no obligation to structure the terms of the grant or any aspect of the Option to reduce or eliminate Participant's liability for Tax-Related Items or achieve any particular tax result.

To the extent determined appropriate by the Company in its sole discretion, the Company will have the right (but not the obligation) to satisfy any Tax-Related Items by (i) withholding from Participant's wages or other cash compensation paid to Participant, (ii) reducing the number of Shares otherwise deliverable to Participant by an amount of Shares with a fair market value equal to Participant's obligation for Tax-Related Items, (iii) withholding from proceeds of the sale of Shares acquired at exercise of the Option either through a voluntary sale or through a mandatory sale arranged by the Company (on Participant's behalf pursuant to this authorization) without further consent, or (iv) any other withholding method that may be approved by the Administrator.

(b) Notice of Disqualifying Disposition of ISO Shares. If the Option granted to Participant herein is an ISO, and if Participant sells or otherwise disposes of any of the Shares acquired pursuant to the ISO on or before the later of (i) the date two (2) years after the Date of Grant, or (ii) the date one (1) year after the date of exercise, Participant will immediately notify the Company in writing of such disposition. Participant agrees that Participant may be subject to income tax withholding by the Company and/or the Employer on any compensation income recognized by Participant.

(c) Section 409A of the Code. For U.S. taxpayers, under Section 409A of the Code, an option that is granted with a per share exercise price that is determined by the U.S. Internal Revenue Service (the "IRS") to be less than the Fair Market Value of a share on the date of grant (a "Discount Option") may be considered "deferred compensation." A Discount Option may result in (i) income recognition by Participant prior to the exercise of the option, (ii) an additional twenty percent (20%) U.S. federal income tax, and (iii) potential penalty and interest charges. The Discount Option may also result in additional state income, penalty and interest charges to Participant. Participant acknowledges that the Company cannot and has not guaranteed that the IRS will agree that the per Share Exercise Price of this Option equals or exceeds the Fair Market Value of a Share on the Date of Grant in a later examination. Participant agrees that if the IRS determines that the Option was granted with a per Share Exercise Price that was less than the Fair Market Value of a Share on the Date of Grant, Participant will be solely responsible for Participant's costs related to such a determination.

7. Nature of Grant. In accepting this Option, Participant acknowledges, understands and agrees that:

(a) the grant of this Option is voluntary and occasional and does not create any contractual or other right to receive future grants of options, or benefits in lieu of options, even if options have been granted in the past;

(b) all decisions with respect to future options or other grants, if any, will be at the sole discretion of the Company;

(c) Participant is voluntarily participating in the Plan;

(d) this Option and any Shares acquired under the Plan, and the income and value of same, are not intended to replace any pension rights or compensation;

(e) this Option and any Shares acquired under the Plan, and the income and value of same, are not part of normal or expected compensation for purposes of calculating any severance, resignation, termination, redundancy, dismissal, end-of-service payments, bonuses, long-service awards, pension or retirement or welfare benefits or similar payments;

(f) the future value of the Shares underlying this Option is unknown, indeterminable, and cannot be predicted with any certainty;

(g) if the underlying Shares do not increase in value, this Option will have no value;

(h) if Participant exercises this Option and acquires Shares, the value of such Shares may increase or decrease in value, even below the Exercise Price;

(i) unless otherwise provided in the Plan or by the Company in its sole discretion, this Option and the benefits evidenced by this Agreement do not create any entitlement to have this Option or any such benefits transferred to, or assumed by, another company nor to be exchanged, cashed out or substituted for, in connection with any corporate transaction affecting the Common Stock;

(j) unless otherwise agreed with the Company, this Option and the Shares underlying this Option, and the income and value of same, are not granted as consideration for, or in connection with, any services Participant may provide as a director of a Subsidiary or affiliate of the Company; and

(k) the following provisions apply only if Participant is providing services outside the U.S.:

(i) No claim or entitlement to compensation or damages shall arise from forfeiture of this Option resulting from the termination of Participant as a Service Provider (for any reason whatsoever, whether or not later found to be invalid or in breach of employment laws in the jurisdiction where Participant is employed or the terms of Participant's employment or service agreement, if any), and in consideration of the grant of this Option to which Participant is otherwise not entitled, Participant irrevocably agrees never to institute any claim against the Company, the Employer or any other Parent or Subsidiary, waives his or her ability, if any, to bring any such claim, and releases the Company, the Employer and any other Parent or Subsidiary from any such claim; if, notwithstanding the foregoing, any such claim is allowed by a court of competent jurisdiction, then, by participating in the Plan, Participant shall be deemed irrevocably to have agreed not to pursue such claim and agrees to execute any and all documents necessary to request dismissal or withdrawal of such claim; and

(ii) Participant acknowledges and agrees that neither the Company, the Employer nor any other Parent or Subsidiary shall be liable for any foreign exchange rate fluctuation between Participant's local currency and the U.S. Dollar that may affect the value of this Option or of any amounts due to Participant pursuant to the exercise of this Option or the subsequent sale of any Shares acquired upon exercise.

## 8. Data Privacy.

(a) Participant hereby explicitly and unambiguously consents to the collection, use and transfer, in electronic or other form, of Participant's personal data as described in this Agreement and any other option grant materials ("Data") by and among, as applicable, the Employer, the Company and any Parent or Subsidiary of the Company for the exclusive purpose of implementing, administering and managing Participant's participation in the Plan.

(b) Participant understands that the Company and the Employer may hold certain personal data about Participant, including, but not limited to, Participant's name, home address and telephone number, email address, date of birth, social insurance, passport or other identification number (e.g., resident registration number), salary, nationality, job title, any Shares or directorships held in the Company, details of all options or any other entitlement to Shares awarded, canceled, exercised, vested, unvested or outstanding in Participant's favor, for the exclusive purpose of implementing, administering and managing the Plan.

(c) Participant understands that Data may be transferred to such stock plan service provider as may be selected by the Company from time to time (the "Designated Broker"), which is assisting the Company with the implementation, administration and management of the Plan. Participant understands that the recipients of Data may be located in the United States or elsewhere, and that the recipient's country (e.g., the United States) may have different data privacy laws and protections than Participant's country. Participant understands that if he or she resides outside the United States, he or she may request a list with the names and addresses of any potential recipients of Data by contacting his or her local human resources representative.

(d) Participant authorizes the Company, the Designated Broker and any possible recipients which may assist the Company (presently or in the future) with implementing, administering and managing the Plan to receive, possess, use, retain and transfer Data, in electronic or other form, for the sole purposes of implementing, administering and managing Participant's participation in the Plan. Participant understands that Data will be held only as long as is necessary to implement, administer and manage Participant's participation in the Plan. Participant understands that if he or she resides outside the United States, he or she may, at any time, view Data, request additional information about the storage and processing of Data, require any necessary amendments to Data or refuse or withdraw the consents herein, in any case without cost, by contacting in writing his or her local human resources representative. Furthermore, Participant understands that the transfer of Data to such recipients is necessary to facilitate Participant's participation in the Plan.

(e) Further, Participant understands that he or she is providing the consents herein on a purely voluntary basis. If Participant does not consent, or if Participant later seeks to revoke his or her consent, his or her employment status or service with the Employer will not be affected; the only consequence of refusing or withdrawing Participant's consent is that the Company would not be able to grant Participant options or other equity awards or administer or

*maintain such awards. Therefore, Participant understands that refusing or withdrawing his or her consent may affect Participant's ability to participate in the Plan. For more information on the consequences of Participant's refusal to consent or withdrawal of consent, Participant understands that he or she may contact his or her local human resources representative.*

9. Rights as Stockholder. Neither Participant nor any person claiming under or through Participant will have any of the rights or privileges of a stockholder of the Company in respect of any Shares deliverable hereunder unless and until certificates representing such Shares will have been issued, recorded on the records of the Company or its transfer agents or registrars, and delivered to Participant (which may be delivered by electronic means pursuant to Section 16 below). After such issuance, recordation and delivery, Participant will have all the rights of a stockholder of the Company with respect to voting such Shares and the receipt of dividends and distributions on such Shares.

10. No Guarantee of Continued Service. PARTICIPANT ACKNOWLEDGES AND AGREES THAT THE VESTING OF THIS OPTION PURSUANT TO THE VESTING SCHEDULE HEREOF IS EARNED ONLY BY CONTINUING AS A SERVICE PROVIDER AT THE WILL OF THE COMPANY OR THE EMPLOYER, AND NOT THROUGH THE ACT OF BEING HIRED, BEING GRANTED THIS OPTION OR ACQUIRING SHARES HEREUNDER. PARTICIPANT FURTHER ACKNOWLEDGES AND AGREES THAT THIS AGREEMENT, THE TRANSACTIONS CONTEMPLATED HEREUNDER AND THE VESTING SCHEDULE SET FORTH HEREIN DO NOT CONSTITUTE AN EXPRESS OR IMPLIED PROMISE OF CONTINUED ENGAGEMENT AS A SERVICE PROVIDER FOR THE VESTING PERIOD, FOR ANY PERIOD, OR AT ALL, AND WILL NOT INTERFERE IN ANY WAY WITH PARTICIPANT'S RIGHT OR THE RIGHT OF THE COMPANY OR THE EMPLOYER TO TERMINATE PARTICIPANT'S RELATIONSHIP AS A SERVICE PROVIDER AT ANY TIME, WITH OR WITHOUT CAUSE.

11. Address for Notices. Any notice to be given to the Company under the terms of this Agreement will be addressed to the Company at Altair Engineering Inc., 1820 East Big Beaver Road, Troy, MI, 48083, USA or at such other address as the Company may hereafter designate in writing.

12. Non-Transferability of Option. This Option may not be transferred in any manner otherwise than by will or by the laws of descent or distribution and may be exercised during the lifetime of Participant only by Participant.

13. Binding Agreement. Subject to the limitation on the transferability of this Option contained herein, this Agreement will be binding upon and inure to the benefit of the heirs, legatees, legal representatives, successors and assigns of the parties hereto.

14. Additional Conditions to Issuance of Shares. If at any time the Company shall determine, in its sole discretion, that the listing, registration, qualification, rule compliance, consent or approval of the Shares upon any securities exchange or under any state, federal or foreign law, the tax code and related regulations or the consent or approval of any governmental regulatory authority is necessary or desirable as a condition to the purchase by, or issuance of Shares to, Participant (or his or her estate) hereunder, such purchase or issuance will not occur

unless and until such listing, registration, qualification, rule compliance, consent or approval shall have been completed, effected or obtained free of any conditions not acceptable to the Company. The Company has sole discretion in its efforts to meet the requirements of any such state, federal or foreign law or securities exchange and to obtain any such consent or approval of any such governmental authority or securities exchange. Assuming such compliance, for purposes of the Tax-Related Items, the Exercised Shares will be considered transferred to Participant on the date the Option is exercised with respect to such Exercised Shares.

15. Administrator Authority. The Administrator will have the power to interpret the Plan and this Agreement and to adopt such rules for the administration, interpretation and application of the Plan as are consistent therewith and to interpret or revoke any such rules (including, but not limited to, the determination of whether or not any Shares subject to the Option have vested). All actions taken and all interpretations and determinations made by the Administrator in good faith will be final and binding upon Participant, the Company and all other interested persons. No member of the Administrator will be personally liable for any action, determination or interpretation made in good faith with respect to the Plan or this Agreement.

16. Electronic Delivery and Acceptance. The Company may, in its sole discretion, decide to deliver any documents related to options awarded under the Plan or future options that may be awarded under the Plan by electronic means or request Participant's consent to participate in the Plan by electronic means. Participant hereby consents to receive such documents by electronic delivery and agrees to participate in the Plan through any on-line or electronic system established and maintained by the Company or a third party designated by the Company.

17. Other Plans. No amounts of income received by Participant pursuant to this Agreement shall be considered compensation for purposes of any pension or retirement plan, insurance plan or any other employee benefit plan of the Company or its Affiliates, unless otherwise expressly provided in such plan.

18. Captions. Captions provided herein are for convenience only and are not to serve as a basis for interpretation or construction of this Agreement.

19. Agreement Severable. In the event that any provision in this Agreement will be held invalid or unenforceable, such provision will be severable from, and such invalidity or unenforceability will not be construed to have any effect on, the remaining provisions of this Agreement.

20. No Advice Regarding Grant. The Company is not providing any tax, legal or financial advice, nor is the Company making any recommendations regarding Participant's participation in the Plan, or Participant's acquisition or sale of the underlying Shares. Participant should consult with his or her own personal tax, legal and financial advisors regarding his or her participation in the Plan before taking any action related to the Plan.

21. Modifications to the Agreement. This Agreement constitutes the entire understanding of the parties on the subjects covered. Participant expressly warrants that he or she is not accepting this Agreement in reliance on any promises, representations, or inducements

other than those contained herein. Modifications to this Agreement or the Plan can be made only in an express written agreement executed by a duly authorized officer of the Company. Notwithstanding anything to the contrary in the Plan or this Agreement, the Company reserves the right to revise this Agreement as it deems necessary or advisable for any legal or administrative reasons, in its sole discretion and without the consent of Participant, including but not limited to compliance with Section 409A of the Code.

22. Amendment, Suspension or Termination of the Plan. By accepting this Award, Participant expressly warrants that he or she has received an option under the Plan, and has received, read and understood a description of the Plan. Participant understands that the Plan is discretionary in nature, is established voluntarily by the Company and may be amended, altered, suspended or terminated by the Company at any time as provided in the Plan.

23. Governing Law and Venue. This Agreement will be governed by the laws of the State of Delaware, without giving effect to the conflict of law principles thereof. For purposes of litigating any dispute that arises under this Award of Options or this Agreement, the parties hereby submit to and consent to the jurisdiction of the State of Michigan, and agree that such litigation will be conducted in the state courts of Detroit, Michigan, or the federal courts for the United States for the Eastern District of Michigan, where the Award of Options is made and/or to be performed, and in no other courts.

24. Language. If Participant has received this Agreement, or any other document related to this Option and/or the Plan translated into a language other than English and if the meaning of the translated version is different than the English version, the English version will control.

25. Insider Trading Restrictions and Market Abuse Laws. Participant acknowledges that, depending on Participant's country, Participant may be subject to insider trading restrictions and/or market abuse laws, which may affect his or her ability to acquire or sell the Shares or rights to the Shares under the Plan during such times as Participant is considered to have "inside information" regarding the Company (as defined by the laws in Participant's country). Any restrictions under these laws or regulations are separate from and in addition to any restrictions that may be imposed under any applicable Company insider trading policy. Participant acknowledges that it is Participant's responsibility to comply with any applicable restrictions, and that Participant should speak to his or her personal advisor on this matter.

26. Foreign Asset and Account Reporting. Participant's country may have certain exchange control and/or foreign asset/account reporting requirements which may affect Participant's ability to acquire or hold Shares under the Plan or cash received from participating in the Plan (including from any dividends received or sale proceeds resulting from the sale of Shares) in a brokerage or bank account outside of Participant's country. Participant may be required to report such accounts, assets or transactions to the tax or other authorities in his or her country. Participant acknowledges that it is his or her responsibility to comply with any applicable regulations, and that Participant should speak to his or her personal advisor on this matter.



27. Non-US Country-Specific Terms and Conditions. Notwithstanding any provisions in this Agreement, this Option shall be subject to the Non-US Country-Specific Terms and Conditions for Participant's country attached to this Agreement as Exhibit B. Moreover, if Participant relocates to one of the countries included therein, the terms and conditions for such country will apply to Participant to the extent the Company determines that the application of such terms and conditions is necessary or advisable for legal or administrative reasons. The Non-US Country-Specific Terms and Conditions constitute part of this Agreement.

28. Waiver. Participant acknowledges that a waiver by the Company of breach of any provision of this Agreement shall not operate or be construed as a waiver of any other provision of this Agreement, or of any subsequent breach by Participant or any other participant.

29. Recoupment. In the event the Company restates its financial statements due to material noncompliance with any financial reporting requirements under applicable securities laws, any shares issued pursuant to this Agreement for or in respect of the year that is restated, or the prior three years, may be recovered to the extent the shares issued exceed the number that would have been issued based on the restatement. In addition and without limitation of the foregoing, any amounts paid hereunder shall be subject to recoupment in accordance with The Dodd–Frank Wall Street Reform and Consumer Protection Act and any implementing regulations thereunder, any clawback policy adopted by the Company or as is otherwise required by applicable law or stock exchange listing conditions.

30. Investment Purpose. The Participant represents and warrants that unless the Shares are registered under the Securities Act, any and all Shares acquired by the Participant under this Agreement will be acquired for investment for the Participant's own account and not with a view to, for resale in connection with, or with an intent of participating directly or indirectly in, any distribution of such Shares within the meaning of the Securities Act. The Participant agrees not to sell, transfer or otherwise dispose of such Shares unless they are either (1) registered under the Securities Act and all applicable state securities laws, or (2) exempt from such registration in the opinion of Company counsel.

---

**EXHIBIT B**

**NON US COUNTRY-SPECIFIC**

**TERMS AND CONDITIONS**

**[TO COME]**

**EXHIBIT C**

**ALTAIR ENGINEERING INC.**

**2017 EQUITY INCENTIVE PLAN**

**EXERCISE NOTICE**

Altair Engineering Inc.  
1820 E. Big Beaver Road  
Troy, Michigan 48083  
USA

Attention: Stock Administration

1. **Exercise of Option.** Effective as of today, \_\_\_\_\_, \_\_\_\_\_, the undersigned ("Purchaser") hereby elects to purchase \_\_\_\_\_ shares (the "Shares") of the Common Stock of Altair Engineering Inc. (the "Company") under and pursuant to its 2017 Equity Incentive Plan (the "Plan") and the Stock Option Agreement dated \_\_\_\_\_ (including any exhibits and terms and conditions thereto, the "Agreement"). The total purchase price for the Shares will be \$ \_\_\_\_\_ (\$ \_\_\_\_\_ /share), as required by the Agreement.

2. **Delivery of Payment.** Purchaser herewith delivers to the Company, or otherwise makes adequate arrangements satisfactory to the Company, the full purchase price of the Shares and any Tax-Related Items (as defined in the Agreement) to be paid in connection with the exercise of the Option.

3. **Representations of Purchaser.** Purchaser acknowledges that Purchaser has received, and has read and understands the Plan and the Agreement, and agrees to abide by and be bound by their terms and conditions.

4. **Rights as Stockholder.** Until the issuance (as evidenced by the appropriate entry on the books of the Company or of a duly authorized transfer agent of the Company) of the Shares, no right to vote or receive dividends or any other rights as a stockholder will exist with respect to the Shares subject to the Option, notwithstanding the exercise of the Option. The Shares so acquired will be issued to Purchaser as soon as practicable after exercise of the Option. No adjustment will be made for a dividend or other right for which the record date is prior to the date of issuance, except as provided in the Plan.

5. **Tax Consultation.** Purchaser understands that Purchaser may suffer adverse tax consequences as a result of Purchaser's purchase or disposition of the Shares. Purchaser represents that Purchaser has consulted with any tax consultants Purchaser deems advisable in connection with the purchase or disposition of the Shares and that Purchaser is not relying on the Company for any tax advice.

6. **Stock Certificate Information.** Purchaser hereby instructs the Company to have the certificate or certificates representing the Shares registered in the following name or names

**PURCHASER MUST CHECK ONE:**

In Purchaser's own name only.

In the name of Purchaser and Purchaser's spouse,  
survivorship.

[INSERT NAME OF SPOUSE], and Purchaser as joint tenants with right of

7. Entire Agreement; Governing Law. The Plan and Agreement are incorporated herein by reference. This Exercise Notice, the Plan and the Agreement constitute the entire agreement of the parties with respect to the subject matter hereof and supersede in their entirety all prior undertakings and agreements of the Company and Purchaser with respect to the subject matter hereof, and may not be modified adversely to Purchaser's interest except by means of a writing signed by the Company and Purchaser. This Agreement is governed by the internal substantive laws, but not the choice of law rules, of the State of Delaware.

Submitted by:

PURCHASER

\_\_\_\_\_  
Signature

\_\_\_\_\_  
Print Name

Accepted by:

ALTAIR ENGINEERING INC.

\_\_\_\_\_  
By

\_\_\_\_\_  
Its

\_\_\_\_\_  
Date Received

**ALTAIR ENGINEERING INC.**

**2017 EQUITY INCENTIVE PLAN**

**RESTRICTED STOCK UNIT AGREEMENT**

Unless otherwise defined herein, the terms defined in the Altair Engineering Inc. 2017 Equity Incentive Plan (the "Plan") will have the same defined meanings in this Restricted Stock Unit Agreement, including the Notice of Restricted Stock Unit Grant (the "Notice of Grant"), the Terms and Conditions of Restricted Stock Unit Grant, attached hereto as Exhibit A, and the Non-US Country-Specific Terms and Conditions, attached hereto as Exhibit B (collectively this "Award Agreement").

**NOTICE OF RESTRICTED STOCK UNIT GRANT**

**Participant:**

\_\_\_\_\_

Participant has been granted the right to receive an Award of Restricted Stock Units, subject to the terms and conditions of the Plan and this Award Agreement, as follows:

Grant Number

\_\_\_\_\_

Date of Grant

\_\_\_\_\_

Vesting Commencement Date

\_\_\_\_\_

Number of Restricted Stock Units

\_\_\_\_\_

**Vesting Schedule:**

Subject to any acceleration provisions contained in the Plan or set forth below, the Restricted Stock Units will vest in accordance with the following schedule:

Subject to Section 3 of the Award Agreement, twenty-five percent (25%) of the Restricted Stock Units shall vest on the one-year anniversary of the Vesting Commencement Date and twenty-five percent (25%) of the Restricted Stock Units shall vest on each anniversary of the Vesting Commencement Date thereafter (such that the Restricted Stock Units shall be fully vested on the fourth anniversary of the Vesting Commencement Date), subject to Participant continuing to be a Service Provider through each such vesting date.

In the event Participant ceases to be a Service Provider for any or no reason before Participant vests in the Restricted Stock Units, the Restricted Stock Units and Participant's right to acquire any Shares hereunder will immediately terminate.

For purposes of this Award, Participant's status as a Service Provider will be considered terminated as of the date Participant is no longer actively providing services to Altair Engineering Inc. (the "Company") or any Parent or Subsidiary of the Company (regardless of the reason for such termination and whether or not later found to be invalid or in breach of

employment laws in the jurisdiction where Participant is employed or the terms of Participant's employment or service agreement, if any), and unless otherwise expressly provided in this Award Agreement or determined by the Company, Participant's right to vest in this Award under the Plan, if any, will terminate as of such date and will not be extended by any notice period (*e.g.*, Participant's period of service would not include any contractual notice period or any period of "garden leave" or similar period mandated under employment laws in the jurisdiction where Participant is employed or the terms of Participant's employment or service agreement, if any). The Administrator shall have the sole discretion to determine when Participant is no longer actively providing services for purposes of his or her Award grant (including whether Participant may still be considered to be providing services while on a leave of absence).

Participant has reviewed the Plan and this Award Agreement in their entirety, has had an opportunity to obtain the advice of counsel prior to executing this Award Agreement and fully understands all provisions of the Plan and this Award Agreement. Participant hereby agrees to accept as binding, conclusive and final all decisions or interpretations of the Administrator upon any questions relating to the Plan and this Award Agreement. Participant further agrees to notify the Company upon any change in the residence address indicated above.

**EXHIBIT A**

**TERMS AND CONDITIONS OF RESTRICTED STOCK UNIT GRANT**

1. Grant. The Company hereby grants to the individual named in the Notice of Grant (the “Participant”) under the Plan an Award of Restricted Stock Units, subject to all of the terms and conditions in this Award Agreement and the Plan, which are incorporated herein by reference. In the event of a conflict between the terms and conditions of the Plan and the terms and conditions of this Award Agreement, the terms and conditions of the Plan will prevail.

2. Company’s Obligation to Pay. Each Restricted Stock Unit represents the right to receive a Share on the date the Restricted Stock Unit vests. Unless and until the Restricted Stock Units vest in the manner set forth in Sections 3 or 4 of this Award Agreement, Participant will have no right to payment of any such Restricted Stock Units. Prior to the actual payment of any vested Restricted Stock Units, such Restricted Stock Units will represent an unsecured obligation of the Company, payable (if at all) only from the general assets of the Company. Any Restricted Stock Units that vest in accordance with Sections 3 or 4 of this Award Agreement will be paid to Participant (or in the event of Participant’s death, to his or her estate) in whole Shares, subject to Participant satisfying any Tax-Related Items as set forth in Section 7 of this Award Agreement. Subject to the provisions of Section 4 of this Award Agreement, such vested Restricted Stock Units shall be paid in whole Shares as soon as practicable after vesting, but in each such case within the period of sixty (60) days following the vesting date. In no event will Participant be permitted, directly or indirectly, to specify the taxable year of the payment of any Restricted Stock Units payable under this Award Agreement.

3. Vesting Schedule. Except as provided in Section 4 of this Award Agreement, and subject to Section 5 of this Award Agreement, the Restricted Stock Units awarded by this Award Agreement will vest in accordance with the vesting provisions set forth in the Notice of Grant. Restricted Stock Units scheduled to vest on a certain date or upon the occurrence of a certain condition will not vest in accordance with any of the provisions of this Award Agreement unless Participant will have been continuously a Service Provider from the Date of Grant until the date such vesting occurs.

4. Administrator Discretion. The Administrator, in its sole discretion, may accelerate the vesting of the balance, or some lesser portion of the balance, of the unvested Restricted Stock Units at any time, subject to the terms of the Plan. If so accelerated, such Restricted Stock Units will be considered as having vested as of the date specified by the Administrator. For U.S. taxpayers, the payment of Shares vesting pursuant to this Section 4 shall in all cases be paid at a time or in a manner that is exempt from, or complies with, Section 409A of the Code.

Notwithstanding anything in the Plan or this Award Agreement to the contrary, if the vesting of the balance, or some lesser portion of the balance, of the Restricted Stock Units is accelerated in connection with Participant’s termination as a Service Provider (provided that such termination is a “separation from service” within the meaning of Section 409A of the Code, as determined by the Company), other than due to death, and if (a) Participant is a “specified employee” within the meaning of Section 409A of the Code at the time of such termination as a Service Provider and (b) the payment of such accelerated Restricted Stock Units will result in the

imposition of additional tax under Section 409A of the Code if paid to Participant on or within the six (6) month period following Participant's termination as a Service Provider, then the payment of such accelerated Restricted Stock Units will not be made until the date six (6) months and one (1) day following the date of Participant's termination as a Service Provider, unless Participant dies following his or her termination as a Service Provider, in which case, the Restricted Stock Units will be paid in Shares to Participant's estate as soon as practicable following his or her death. It is the intent of this Award Agreement that it and all payments and benefits hereunder be exempt from, or comply with, the requirements of Section 409A of the Code so that none of the Restricted Stock Units provided under this Award Agreement or Shares issuable hereunder will be subject to the additional tax imposed under Section 409A of the Code, and any ambiguities herein will be interpreted to be so exempt or so comply. Each payment payable under this Award Agreement is intended to constitute a separate payment for purposes of Section 409A of the Code

5. Forfeiture upon Termination of Status as a Service Provider. Notwithstanding any contrary provision of this Award Agreement, the balance of the Restricted Stock Units that have not vested as of the time of Participant's termination as a Service Provider for any or no reason and Participant's right to acquire any Shares will immediately terminate.

6. Death of Participant. Any distribution or delivery to be made to Participant under this Award Agreement will, if Participant is then deceased, be made to Participant's designated beneficiary, if so allowed by the Administrator in its sole discretion, or if no beneficiary survives Participant, the administrator or executor of Participant's estate. Any such transferee must furnish the Company with (a) written notice of his or her status as transferee, and (b) evidence satisfactory to the Company to establish the validity of the transfer and compliance with any laws or regulations pertaining to said transfer.

7. Tax Obligations.

(a) General. Participant acknowledges that, regardless of any action taken by the Company or, if different, Participant's employer (the "Employer") the ultimate liability for all income tax, social insurance, payroll tax, fringe benefits tax, payment on account or other tax-related items related to Participant's participation in the Plan and legally applicable to Participant ("Tax-Related Items"), is and remains Participant's responsibility and may exceed the amount actually withheld by the Company or the Employer. Participant further acknowledges that the Company and/or the Employer: (i) make no representations or undertakings regarding the treatment of any Tax-Related Items in connection with any aspect of the Restricted Stock Units, including, but not limited to, the grant, vesting or settlement of the Restricted Stock Units, the subsequent sale of Shares acquired pursuant to such settlement and the receipt of any dividends; and (ii) do not commit to and are under no obligation to structure the terms of the grant or any aspect of the Restricted Stock Units to reduce or eliminate Participant's liability for Tax-Related Items or achieve any particular tax result. Further, if Participant is subject to Tax-Related Items in more than one jurisdiction, Participant acknowledges that the Company and/or the Employer (or former employer, as applicable) may be required to withhold or account for Tax-Related Items in more than one jurisdiction.



Prior to any relevant taxable or tax withholding event, as applicable, Participant will pay or make adequate arrangements satisfactory to the Company and/or the Employer to satisfy all Tax-Related Items. In this regard, and subject to applicable local law, Participant authorizes the Company and/or the Employer, or their respective agents, at their sole discretion, to satisfy all Tax-Related Items by withholding from Participant's wages or other cash compensation paid to Participant by the Company and/or the Employer or withholding from proceeds of the sale of Shares acquired upon vesting of the Restricted Stock Units, either through a voluntary sale or through a mandatory sale arranged by the Company (on Participant's behalf pursuant to this authorization) without further consent from Participant.

If permissible under applicable local law, the minimum federal, state, and local and foreign income, social insurance, payroll, employment and any other applicable taxes which the Employer determines must be withheld with respect to this Award ("Tax Withholding Obligation") may be satisfied by Shares being sold on Participant's behalf at the prevailing market price pursuant to such procedures as the Company may specify from time to time, including through a broker-assisted arrangement (it being understood that the Shares to be sold must have vested pursuant to the terms of this Award Agreement and the Plan). In addition to Shares sold to satisfy the Tax Withholding Obligation, additional Shares may be sold to satisfy any associated broker or other fees. The proceeds from any sale will be used to satisfy Participant's Tax Withholding Obligation arising with respect to this Award and any associated broker or other fees. Only whole Shares will be sold. Any proceeds from the sale of Shares in excess of the Tax Withholding Obligation and any associated broker or other fees will be paid to Participant in accordance with procedures the Company may specify from time to time.

The Administrator may permit Participant to satisfy Participant's Tax Withholding Obligation by (i) delivering to the Company Shares that Participant owns and that have vested with a fair market value equal to the amount required to be withheld, (ii) having the Company withhold otherwise deliverable Shares having a value equal to the minimum amount statutorily required to be withheld, (iii) payment by Participant in cash, or (iv) such other means as the Administrator deems appropriate.

(b) Executive Officers and Directors. Notwithstanding anything herein to the contrary, if Participant is an "executive officer" within the meaning of Rule 16(a)(1)(f) under the Exchange Act or a Director, then the Tax Withholding Obligation will be satisfied by the Company by having the Company withhold otherwise deliverable Shares having a value equal to the minimum amount statutorily required to be withheld.

(c) Company's Obligation to Deliver Shares. For clarification purposes, in no event will the Company issue Participant any Shares unless and until arrangements satisfactory to the Administrator have been made for the payment of Participant's Tax Withholding Obligation. If Participant fails to do so by the time they become due, Participant will permanently forfeit Participant's Restricted Stock Units to which Participant's Tax Withholding Obligation relates, as well as any right to receive Shares otherwise issuable pursuant to those Restricted Stock Units.

8. Nature of Grant. In accepting the award, Participant acknowledges, understands and agrees that:

(a) the Plan is established voluntarily by the Company, it is discretionary in nature and it may be modified, amended, suspended or terminated by the Company at any time, to the extent permitted by the Plan;

(b) the Award of Restricted Stock Units is voluntary and occasional and does not create any contractual or other right to receive future awards of Restricted Stock Units, or benefits in lieu of Restricted Stock Units, even if Restricted Stock Units have been awarded in the past;

(c) all decisions with respect to future Restricted Stock Units or other awards, if any, will be at the sole discretion of the Company;

(d) Participant is voluntarily participating in the Plan;

(e) the Award of Restricted Stock Units and the Shares subject to the Restricted Stock Units, and the income and value of same, are not intended to replace any pension rights or compensation;

(f) the Award of Restricted Stock Units and the Shares subject to the Restricted Stock Units, and the income and value of same, are not part of normal or expected compensation for purposes of calculating any severance, resignation, termination, redundancy, dismissal, end-of-service payments, bonuses, long-service awards, pension or retirement or welfare benefits or similar payments;

(g) the future value of the underlying Shares is unknown, indeterminable and cannot be predicted with any certainty;

(h) unless otherwise provided in the Plan or by the Company in its sole discretion, the Restricted Stock Units and the benefits evidenced by this Award Agreement do not create any entitlement to have the Restricted Stock Units or any such benefits transferred to, or assumed by, another company nor be exchanged, cashed out or substituted for, in connection with any corporate transaction affecting the Common Stock;

(i) unless otherwise agreed with the Company, the Restricted Stock Units and the Shares subject to the Restricted Stock Units, and the income and value of same, are not granted as consideration for, or in connection with, any services Participant may provide as a director of a Subsidiary of the Company; and

(j) the following provisions apply only if Participant is providing services outside the United States:

(i) no claim or entitlement to compensation or damages shall arise from forfeiture of the Restricted Stock Units resulting from the termination of Participant as a Service Provider (for any reason whatsoever whether or not later found to be invalid or in breach of employment laws in the jurisdiction where Participant is employed or the terms of Participant's employment or service agreement, if any), and in consideration of the award of the Restricted Stock Units to which Participant is otherwise not entitled, Participant irrevocably agrees never to institute any claim against the Company, the

Employer or any other Parent or Subsidiary of the Company, waives his or her ability, if any, to bring any such claim, and releases the Company, the Employer or any other Parent or Subsidiary from any such claim; if, notwithstanding the foregoing, any such claim is allowed by a court of competent jurisdiction, then, by participating in the Plan, Participant shall be deemed irrevocably to have agreed not to pursue such claim and agrees to execute any and all documents necessary to request dismissal or withdrawal of such claim; and

(ii) Participant acknowledges and agrees that neither the Company, the Employer nor any Parent or Subsidiary of the Company shall be liable for any foreign exchange rate fluctuation between Participant's local currency and the United States Dollar that may affect the value of the Restricted Stock Units or of any amounts due to Participant pursuant to the settlement of the Restricted Stock Units or the subsequent sale of any Shares acquired upon settlement.

#### 9. Data Privacy.

(a) Participant hereby explicitly and unambiguously consents to the collection, use and transfer, in electronic or other form, of Participant's personal data as described in this Award Agreement and any other grant materials ("Data") by and among, as applicable, the Employer, the Company and any Parent or Subsidiary of the Company, for the exclusive purpose of implementing, administering and managing Participant's participation in the Plan.

(b) Participant understands that the Company and the Employer may hold certain personal data about Participant, including, but not limited to, Participant's name, home address and telephone number, email address, date of birth, social insurance, passport or other identification number (e.g., resident registration number), salary, nationality, job title, any Shares or directorships held in the Company, details of all Restricted Stock Units or any other entitlement to Shares awarded, canceled, exercised, vested, unvested or outstanding in Participant's favor, for the exclusive purpose of implementing, administering and managing the Plan.

(c) Participant understands that Data may be transferred to such other stock plan service provider as may be selected by the Company from time to time (the "Designated Broker"), which is assisting the Company with the implementation, administration and management of the Plan. Participant understands that the recipients of Data may be located in the United States or elsewhere, and that the recipients' country (e.g., the United States) may have different data privacy laws and protections than Participant's country. Participant understands that if he or she resides outside the United States, he or she may request a list with the names and addresses of any potential recipients of Data by contacting his or her local human resources representative. Furthermore, Participant understands that the transfer of Data to such recipients is necessary to facilitate Participant's participation in the Plan.

(d) Participant authorizes the Company, the Designated Broker and any possible recipients which may assist the Company (presently or in the future) with implementing, administering and managing the Plan to receive, possess, use, retain and transfer Data, in

electronic or other form, for the sole purpose of implementing, administering and managing his or her participation in the Plan. Participant understands that Data will be held only as long as is necessary to implement, administer and manage Participant's participation in the Plan. Participant understands if he or she resides outside the United States, he or she may, at any time, view Data, request additional information about the storage and processing of Data, require any necessary amendments to Data or refuse or withdraw the consents herein, in any case without cost, by contacting in writing his or her local human resources representative.

(e) Further, Participant understands that he or she is providing the consents herein on a purely voluntary basis. If Participant does not consent, or if Participant later seeks to revoke his or her consent, his or her employment status or service with the Employer will not be affected; the only consequence of refusing or withdrawing Participant's consent is that the Company would not be able to grant Participant Restricted Stock Units or other equity awards or administer or maintain such awards. Therefore, Participant understands that refusing or withdrawing his or her consent may affect Participant's ability to participate in the Plan. For more information on the consequences of Participant's refusal to consent or withdrawal of consent, Participant understands that he or she may contact his or her local human resources representative.

10. Rights as Stockholder. Neither Participant nor any person claiming under or through Participant will have any of the rights or privileges of a stockholder of the Company in respect of any Shares deliverable hereunder unless and until certificates representing such Shares will have been issued, recorded on the records of the Company or its transfer agents or registrars, and delivered to Participant (which may be delivered by electronic means pursuant to Section 17 below). After such issuance, recordation and delivery, Participant will have all the rights of a stockholder of the Company with respect to voting such Shares and the receipt of dividends and distributions on such Shares.

11. No Guarantee of Continued Service. PARTICIPANT ACKNOWLEDGES AND AGREES THAT THE VESTING OF THE RESTRICTED STOCK UNITS PURSUANT TO THE VESTING SCHEDULE HEREOF IS EARNED ONLY BY CONTINUING AS A SERVICE PROVIDER AT THE WILL OF THE COMPANY OR THE EMPLOYER, AND NOT THROUGH THE ACT OF BEING HIRED, BEING GRANTED THIS AWARD OF RESTRICTED STOCK UNITS OR ACQUIRING SHARES HEREUNDER. PARTICIPANT FURTHER ACKNOWLEDGES AND AGREES THAT THIS AWARD AGREEMENT, THE TRANSACTIONS CONTEMPLATED HEREUNDER AND THE VESTING SCHEDULE SET FORTH HEREIN DO NOT CONSTITUTE AN EXPRESS OR IMPLIED PROMISE OF CONTINUED ENGAGEMENT AS A SERVICE PROVIDER FOR THE VESTING PERIOD, FOR ANY PERIOD, OR AT ALL, AND WILL NOT INTERFERE IN ANY WAY WITH PARTICIPANT'S RIGHT OR THE RIGHT OF THE COMPANY OR THE EMPLOYER TO TERMINATE PARTICIPANT'S RELATIONSHIP AS A SERVICE PROVIDER AT ANY TIME, WITH OR WITHOUT CAUSE.

12. Address for Notices. Any notice to be given to the Company under the terms of this Award Agreement will be addressed to the Company at Altair Engineering Inc., 1820 East Big Beaver Road, Troy, MI, 48083, USA or at such other address as the Company may hereafter designate in writing.

13. Grant is Not Transferable. Except to the limited extent provided in Section 6, this grant and the rights and privileges conferred hereby may not be transferred, assigned, pledged or hypothecated in any way (whether by operation of law or otherwise) and may not be subject to sale under execution, attachment or similar process. Upon any attempt to transfer, assign, pledge, hypothecate or otherwise dispose of this grant, or any right or privilege conferred hereby, or upon any attempted sale under any execution, attachment or similar process, this grant and the rights and privileges conferred hereby immediately will become null and void.

14. Binding Agreement. Subject to the limitation on the transferability of this grant contained herein, this Award Agreement will be binding upon and inure to the benefit of the heirs, legatees, legal representatives, successors and assigns of the parties hereto.

15. Additional Conditions to Issuance of Shares. If at any time the Company shall determine, in its sole discretion, that the listing, registration, qualification, rule compliance, consent or approval of the Shares upon any securities exchange or under any state, federal or foreign law, the tax code and related regulations or the consent or approval of any governmental regulatory authority is necessary or desirable as a condition to the issuance of Shares to Participant (or his or her estate) hereunder, such issuance will not occur unless and until such listing, registration, qualification, rule compliance, consent or approval shall have been completed, effected or obtained free of any conditions not acceptable to the Company. Where the Company determines that the delivery of the payment of any Shares will violate any state, federal or foreign securities or exchange laws or other applicable laws, the Company will defer delivery until the earliest date at which the Company reasonably anticipates that the delivery of Shares will no longer cause such violation. The Company has sole discretion in its efforts to meet the requirements of any such local, state, federal or foreign law or securities exchange and to obtain any such consent or approval of any such governmental authority or securities exchange.

16. Administrator Authority. The Administrator will have the power to interpret the Plan and this Award Agreement and to adopt such rules for the administration, interpretation and application of the Plan as are consistent therewith and to interpret or revoke any such rules (including, but not limited to, the determination of whether or not any Restricted Stock Units have vested). All actions taken and all interpretations and determinations made by the Administrator in good faith will be final and binding upon Participant, the Company and all other interested persons. No member of the Administrator will be personally liable for any action, determination or interpretation made in good faith with respect to the Plan or this Award Agreement.

17. Electronic Delivery and Acceptance. The Company may, in its sole discretion, decide to deliver any documents related to Restricted Stock Units awarded under the Plan or future Restricted Stock Units that may be awarded under the Plan by electronic means or request Participant's consent to participate in the Plan by electronic means. Participant hereby consents to receive such documents by electronic delivery and agrees to participate in the Plan through any on-line or electronic system established and maintained by the Company or a third party designated by the Company.

18. Other Plans. No amounts of income received by Participant pursuant to this Award Agreement shall be considered compensation for purposes of any pension or retirement plan, insurance plan or any other employee benefit plan of the Company or its Affiliates, unless otherwise expressly provided in such plan.

19. Captions. Captions provided herein are for convenience only and are not to serve as a basis for interpretation or construction of this Award Agreement.

20. Agreement Severable. In the event that any provision in this Award Agreement will be held invalid or unenforceable, such provision will be severable from, and such invalidity or unenforceability will not be construed to have any effect on, the remaining provisions of this Award Agreement.

21. No Advice Regarding Grant. The Company is not providing any tax, legal or financial advice, nor is the Company making any recommendations regarding Participant's participation in the Plan, or Participant's acquisition or sale of the underlying Shares. Participant should consult with his or her own personal tax, legal and financial advisors regarding his or her participation in the Plan before taking any action related to the Plan.

22. Modifications to the Award Agreement. This Award Agreement constitutes the entire understanding of the parties on the subjects covered. Participant expressly warrants that he or she is not accepting this Award Agreement in reliance on any promises, representations, or inducements other than those contained herein. Modifications to this Award Agreement or the Plan can be made only in an express written contract executed by a duly authorized officer of the Company. Notwithstanding anything to the contrary in the Plan or this Award Agreement, the Company reserves the right to revise this Award Agreement as it deems necessary or advisable for any legal or administrative reasons, in its sole discretion and without the consent of Participant, including but not limited to the compliance with Section 409A of the Code.

23. Amendment, Suspension or Termination of the Plan. By accepting this award, Participant expressly warrants that he or she has received an Award of Restricted Stock Units under the Plan, and has received, read and understood a description of the Plan. Participant understands that the Plan is discretionary in nature and may be amended, altered, suspended or terminated by the Company at any time as provided in the Plan.

24. Governing Law and Venue. This Award Agreement will be governed by the laws of the State of Delaware, without giving effect to the conflict of law principles thereof. For purposes of litigating any dispute that arises under this Award of Restricted Stock Units or this Award Agreement, the parties hereby submit to and consent to the jurisdiction of the State of Michigan, and agree that such litigation will be conducted in the state courts of Detroit, Michigan, or the federal courts for the United States for the Eastern District of Michigan, where the Award of Restricted Stock Units is made and/or to be performed, and in no other courts.

25. Language. If Participant has received this Award Agreement, or any other document related to this Award of Restricted Stock Units and/or the Plan translated into a language other than English and if the meaning of the translated version is different than the English version, the English version will control.

26. Insider Trading Restrictions and Market Abuse Laws. Participant acknowledges that, depending on Participant's country, Participant may be subject to insider trading restrictions and/or market abuse laws, which may affect his or her ability to acquire or sell the Shares or rights to the Shares under the Plan during such times as Participant is considered to have "inside information" regarding the Company (as defined by the laws in Participant's country). Any restrictions under these laws or regulations are separate from and in addition to any restrictions that may be imposed under any applicable Company insider trading policy. Participant acknowledges that it is Participant's responsibility to comply with any applicable restrictions, and that Participant should speak to his or her personal advisor on this matter.

27. Foreign Asset and Account Reporting. Participant's country may have certain exchange control and/or foreign asset/account reporting requirements which may affect Participant's ability to acquire or hold Shares under the Plan or cash received from participating in the Plan (including from any dividends or dividend equivalents received or sale proceeds resulting from the sale of Shares) in a brokerage or bank account outside of Participant's country. Participant may be required to report such accounts, assets or transactions to the tax or other authorities in his or her country. Participant acknowledges that it is his or her responsibility to comply with any applicable regulations, and that Participant should speak to his or her personal advisor on this matter.

28. Country-Specific Terms and Conditions. Notwithstanding any provisions in this Award Agreement, this Award of Restricted Stock Units shall be subject to the Country-Specific Terms and Conditions for Participant's country attached to this Award Agreement as Exhibit B. Moreover, if Participant relocates to one of the countries included therein, the terms and conditions for such country will apply to Participant to the extent the Company determines that the application of such terms and conditions is necessary or advisable for legal or administrative reasons. The Country-Specific Terms and Conditions constitute part of this Award Agreement.

29. Waiver. Participant acknowledges that a waiver by the Company of breach of any provision of this Award Agreement shall not operate or be construed as a waiver of any other provision of this Award Agreement, or of any subsequent breach by Participant or any other participant.

30. Recoupment. In the event the Company restates its financial statements due to material noncompliance with any financial reporting requirements under applicable securities laws, any shares issued pursuant to this Award Agreement for or in respect of the year that is restated, or the prior three years, may be recovered to the extent the shares issued exceed the number that would have been issued based on the restatement. In addition and without limitation of the foregoing, any amounts paid hereunder shall be subject to recoupment in accordance with The Dodd–Frank Wall Street Reform and Consumer Protection Act and any implementing regulations thereunder, any clawback policy adopted by the Company or as is otherwise required by applicable law or stock exchange listing conditions.

31. Investment Purpose. The Participant represents and warrants that unless the Shares are registered under the Securities Act, any and all Shares acquired by the Participant under this Agreement will be acquired for investment for the Participant's own account and not with a view to, for resale in connection with, or with an intent of participating directly or

indirectly in, any distribution of such Shares within the meaning of the Securities Act. The Participant agrees not to sell, transfer or otherwise dispose of such Shares unless they are either (1) registered under the Securities Act and all applicable state securities laws, or (2) exempt from such registration in the opinion of Company counsel.



---

**EXHIBIT B**

**NON-US COUNTRY-SPECIFIC**

**TERMS AND CONDITIONS**

**[TO COME]**

**ALTAIR ENGINEERING INC.**

**2017 EQUITY INCENTIVE PLAN**

**CASH-BASED AWARD AGREEMENT**

Unless otherwise defined herein, the terms defined in the Altair Engineering Inc. 2017 Equity Incentive Plan (the "Plan") will have the same defined meanings in this Cash-Based Award Agreement, including the Notice of Cash-Based Award (the "Notice of Grant") and the Terms and Conditions of Cash-Based Award, attached hereto as Exhibit A (together, this "Award Agreement").

**NOTICE OF CASH-BASED AWARD**

**Participant:**

---

Participant has been granted a Cash-Based Award by Altair Engineering Inc. (the "Company"), subject to the terms and conditions of the Plan and this Award Agreement, as follows:

Date of Grant:

Vesting Commencement Date:

Performance Period:

Maximum Award Amount:

Performance Measures:

Participant has reviewed the Plan and this Award Agreement in their entirety, has had an opportunity to obtain the advice of independent counsel prior to executing this Award Agreement and fully understands all provisions of the Plan and this Award Agreement. Participant hereby agrees to accept as binding, conclusive and final all decisions or interpretations of the Administrator upon any questions relating to the Plan and this Award Agreement.

**EXHIBIT A**

**TERMS AND CONDITIONS OF CASH-BASED AWARD**

1. **Award.** The Company hereby awards the Participant an Other Cash-Based Award (the “Cash-Based Award”) for the performance period set forth in the Notice of Grant (the “Performance Period”). The maximum amount of the Cash-Based Award is set forth in the Notice of Grant (the “Maximum Award Amount”). The actual dollar amount of the Cash-Based Award paid hereunder is dependent upon the satisfaction of the performance conditions set forth in the Notice of Grant (the “Performance Measures”) and may range from 0% to 100% of the Maximum Award Amount. Notwithstanding the foregoing, the Committee may, in its discretion, reduce the amount of the Cash-Based Award payable based on such factors as may be determined by the Committee in its sole discretion, including, without limitation, a determination by the Committee that such a reduction is appropriate in light of pay practices of competitors, or the performance of the Company or any of its Subsidiaries, Parents or Affiliates.

2. **Form and Timing of Payment.** The total amount of the Cash-Based Award that is earned shall be paid by the Company to the Participant in cash, less applicable tax withholdings, within thirty (30) days following certification by the Committee of the attainment of the performance goals set forth in the Notice of Grant for the Performance Period but in all events no later than December 31 of the year following the year in which the Performance Period ends; provided that the Participant remains a Service Provider to the Company or any of its Subsidiaries, Parents or Affiliates through the date of payment (the “Payment Date”).

3. **Tax Withholding.** The Participant acknowledges that, regardless of any action taken by the Company or, if different, Participant’s employer (the “Employer”), the ultimate liability for all income tax, social insurance, payroll tax, fringe benefits tax, payment on account or other tax-related items related to the Participant’s participation in the Plan and legally applicable to Participant (“Tax-Related Items”), is and remains Participant’s responsibility and may exceed the amount actually withheld by the Company or the Employer. If Participant is subject to Tax-Related Items in more than one jurisdiction, Participant acknowledges that the Company and/or the Employer (or former employer, as applicable) may be required to withhold or account for Tax-Related Items in more than one jurisdiction. Participant further acknowledges that the Company and/or the Employer make no representations or undertakings regarding the treatment of any Tax-Related Items in connection with any aspect of the Cash-Based Award.

To the extent determined appropriate by the Administrator in its sole discretion, the Company (or the Employer, as applicable) will have the right (but not the obligation) to satisfy any Tax-Related Items by (i) withholding from Participant’s wages or other cash compensation paid to Participant, or (ii) any other withholding method that may be approved the Administrator.

4. **No Guarantee of Continued Service.** PARTICIPANT ACKNOWLEDGES AND AGREES THAT THIS AWARD AGREEMENT AND THE TRANSACTIONS CONTEMPLATED HEREUNDER DO NOT CONSTITUTE AN EXPRESS OR

IMPLIED PROMISE OF CONTINUED ENGAGEMENT AS A SERVICE PROVIDER FOR THE PERFORMANCE PERIOD, OR FOR ANY PERIOD AT ALL, AND WILL NOT INTERFERE IN ANY WAY WITH PARTICIPANT'S RIGHT OR THE RIGHT OF THE COMPANY OR THE EMPLOYER TO TERMINATE PARTICIPANT'S RELATIONSHIP AS A SERVICE PROVIDER AT ANY TIME, WITH OR WITHOUT CAUSE.

5. Address for Notices. Any notice to be given to the Company under the terms of this Award Agreement will be addressed to the Company at Altair Engineering Inc., 1820 East Big Beaver Road, Troy, MI, 48083, USA or at such other address as the Company may hereafter designate in writing. Any notice to be given to the Participant under the terms of this Award Agreement will be addressed to the Participant at the most recent address shown for him or her on the books and records of the Company.

6. Binding Agreement. Subject to the limitation on the transferability of this Cash-Based Award contained herein, this Award Agreement will be binding upon and inure to the benefit of the heirs, legatees, legal representatives, successors and assigns of the parties hereto.

7. Section 162(m) Compliance. Notwithstanding anything in this Award Agreement to the contrary, if the Participant is a "covered employee" within the meaning of Section 162(m) of the Code and this Cash-Based Award is not exempt from the deduction limitation under Section 162(m) of the Code by virtue of the exception under Treas. Reg. Sec. 1.162-27(f), (i) no amounts shall be paid under this Award Agreement unless the material terms of the performance goals hereunder have been approved by the stockholders of the Company in accordance with Section 162(m) of the Code, (ii) prior to the payment of any amounts under this Award Agreement, the Committee must certify in writing that the applicable performance goals and all other material terms and conditions to payment were in fact satisfied, and (iii) the Committee shall not exercise discretion to adjust any component of the performance goals hereunder or the amount of the Cash-Based Award in a manner that is precluded by Section 162(m) of the Code.

8. Administrator Authority. The Administrator will have the power to interpret the Plan and this Award Agreement and to adopt such rules for the administration, interpretation and application of the Plan as are consistent therewith and to interpret or revoke any such rules. All actions taken and all interpretations and determinations made by the Administrator in good faith will be final and binding upon Participant, the Company and all other interested persons. No member of the Administrator will be personally liable for any action, determination or interpretation made in good faith with respect to the Plan or this Award Agreement.

9. Electronic Acceptance. The Company may, in its sole discretion, decide to deliver any documents related to Cash-Based Awards under the Plan by electronic means or request Participant's consent to participate in the Plan by electronic means. Participant hereby consents to receive such documents by electronic delivery and agrees to participate in the Plan through any on-line or electronic system established and maintained by the Company or a third party designated by the Company.

10. Other Plans. No amounts of income received by Participant pursuant to this Award Agreement shall be considered compensation for purposes of any pension or retirement plan, insurance plan or any other employee benefit plan of the Company or its Affiliates, unless otherwise expressly provided in such plan.

11. Captions. Captions provided herein are for convenience only and are not to serve as a basis for interpretation or construction of this Award Agreement.

12. Agreement Severable. In the event that any provision in this Award Agreement will be held invalid or unenforceable, such provision will be severable from, and such invalidity or unenforceability will not be construed to have any effect on, the remaining provisions of this Award Agreement.

13. No Advice Regarding Grant. The Company is not providing any tax, legal or financial advice, nor is the Company making any recommendations regarding Participant's participation in the Plan. Participant should consult with his or her own personal tax, legal and financial advisors regarding his or her participation in the Plan before taking any action related to the Plan.

14. Modifications to the Award Agreement. This Award Agreement, together with the Plan, constitutes the entire understanding of the parties on the subjects covered. Participant expressly warrants that he or she is not accepting this Award Agreement in reliance on any promises, representations, or inducements other than those contained herein. Modifications to this Award Agreement or the Plan can be made only in an express written contract executed by a duly authorized officer of the Company. Notwithstanding anything to the contrary in the Plan or this Award Agreement, the Company reserves the right to revise this Award Agreement as it deems necessary or advisable for any legal or administrative reasons, in its sole discretion and without the consent of Participant, including but not limited to compliance with Section 409A of the Code.

15. Amendment, Suspension or Termination of the Plan. By accepting this award, Participant expressly warrants that he or she has received a Cash-Based Award under the Plan, and has received, read and understood a description of the Plan. Participant understands that the Plan is discretionary in nature and may be amended, altered, suspended or terminated by the Company at any time as provided in the Plan.

16. Governing Law and Venue. This Award Agreement will be governed by the laws of the State of Delaware, without giving effect to the conflict of law principles thereof. For purposes of litigating any dispute that arises under this Cash-Based Award or this Award Agreement, the parties hereby submit to and consent to the jurisdiction of the State of Michigan, and agree that such litigation will be conducted in the state courts of Detroit, Michigan, or the federal courts for the United States for the Eastern District of Michigan, where the Cash-Based Award is made and/or to be performed, and in no other courts.

17. No Rights as Stockholder. Nothing contained herein shall be deemed to convey to the Participant the rights of a stockholder or equity owner of the Company or any of its Subsidiaries, Parents or Affiliates.

18. Waiver. Participant acknowledges that a waiver by the Company of a breach of any provision of this Award Agreement shall not operate or be construed as a waiver of any other provision of this Award Agreement, or of any subsequent breach by Participant or any other participant.

19. Recoupment. In the event the Company restates its financial statements due to material noncompliance with any financial reporting requirements under applicable securities laws, any payments pursuant to this Cash-Based Award for or in respect of the year that is restated, or the prior three years, may be recovered to the extent the payments made exceed the amount that would have been made as a result of the restatement. In addition and without limitation of the foregoing, any amounts paid hereunder shall be subject to recoupment in accordance with The Dodd–Frank Wall Street Reform and Consumer Protection Act and any implementing regulations thereunder, any clawback policy adopted by the Company or as is otherwise required by applicable law or stock exchange listing conditions.

20. Miscellaneous. The Cash-Based Award may not be transferred in any manner. The Cash-Based Award represents an unfunded, unsecured obligation of the Company. The Cash-Based Award shall be subject to the terms and conditions set forth in this Award Agreement and the provisions of the Plan, the terms of which are incorporated herein by reference.

21. Section 409A. It is the intent of this Award Agreement that it and all payments and benefits hereunder be exempt from, or comply with, the requirements of Section 409A of the Code so that the Cash-Based Award shall not be subject to the additional tax imposed under Section 409A of the Code, and any ambiguities herein will be interpreted to be so exempt or so comply. Each payment payable under this Award Agreement is intended to constitute a separate payment for purposes of Section 409A of the Code.

## LIST OF SUBSIDIARIES

<u>Subsidiary</u>	<u>Jurisdiction of Organization</u>
Altair Product Design, Inc.	Michigan, United States
Altair Engineering IndiaPvt.	India
Altair Engineering Ltd.	Japan
Altair Engineering GmbH	Germany
Altair Engineering France, Sarl	France
Altair Engineering Software Co., Ltd	China
Altair Engineering Ltd.	United Kingdom
ilumisys, Inc.	Michigan, United States
solidThinking, Inc.	Michigan, United States
Weyv, Inc.	Michigan, United States

**Consent of Independent Registered Public Accounting Firm**

We consent to the reference to our firm under the caption “Experts” and to the use of our report dated June 16, 2017, (except as to the third paragraph of Note 2, as to which the date is October 6, 2017), in Amendment No. 1 to the Registration Statement (Form S-1 No. 333-220710) and related Prospectus of Altair Engineering Inc. for the registration of shares of its common stock.

/s/ Ernst & Young LLP

Detroit, Michigan  
October 6, 2017